

# BUSHCRAFT 8

BUSH LEATHERWORK

Ron Edwards

Stocking & Pulled Boots



Knit Hand Leatherwork



Overlaid Hand



Knit Hand Leatherwork



Knit Hand Leatherwork



Knit Hand Leatherwork



Foot Worn Boot Straps



# BUSH LEATHERWORK

## RON EDWARDS



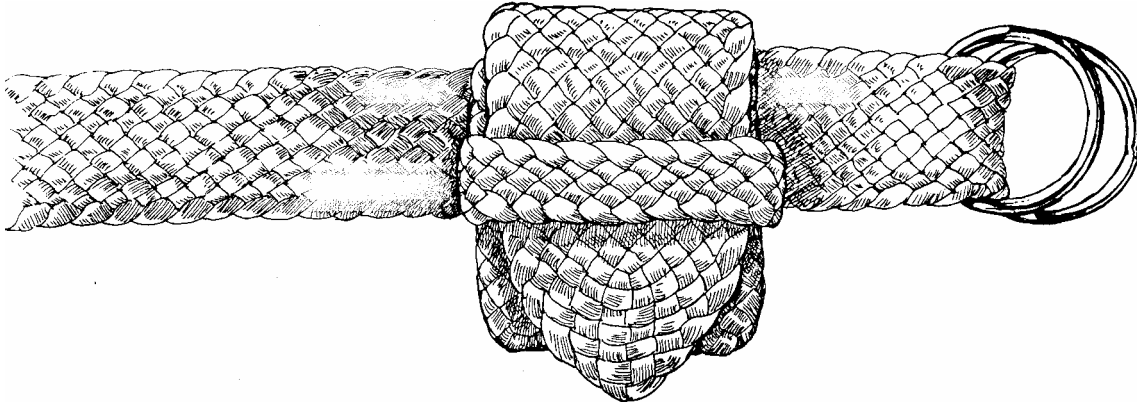

By the same author-

AUSTRALIAN TRADITIONAL  
BUSH CRAFTS

SKILLS OF THE AUSTRALIAN  
BUSHMAN

MAKING A STOCK SADDLE

THE AUSTRALIAN YARN

OVERLANDER SONGBOOK

MUD BRICK AND EARTH  
BUILDING THE CHINESE WAY

YARNS AND BALLADS OF THE  
AUSTRALIAN BUSH

# BUSH LEATHERWORK

RON EDWARDS

THE RAMS SKULL PRESS

In 1982 I began writing a series of small books dealing with various aspects of leatherwork concentrating on the special skills and techniques that have been developed in the Australian bush over the past century.

Fortunately these skills have not vanished, and in fact interest in them seems to be growing. There are a number of plaiters working today whose skills equal that of any of the great names from the past, and many bush people are once again making their own leather gear. We know this from the increase in orders from outback areas of north Queensland that come into our saddlery business in Cairns.

At present I have written and published eleven small books on leather, and they are all in this one volume, plus a section on making thread, taken from my book 'Making a Stock Saddle.

Ron Edwards.  
November 1984

This eBook version was scanned and proofed by Ten80. These books are becoming hard to get even in Australia. So I hope the by converting them to electronic format that I can introduce new readers to the joys of Ron Edwards' unique style. After all, the more of us wanting his titles, the more likely there are to be reprints.

If you enjoy this book, please strongly consider sending Ron a donation at the address below, and ask for copies of his other books - they are well worth the reading too.

I hope you find this, my first scanning attempt, of use.

Thanks,

Ten80.

Copyright Ron Edwards 1984  
THE RAMS SKULL PRESS  
Box 274 Kuranda  
Qld 4872  
Australia  
Ph (070) 937474

Also obtainable from  
CRAFT SHOP SADDLERY  
61 Grafton St Cairns 4870

ISBN 0 909901 47 3

# INDEX

1. STOCKMEN'S PLAITED BELTS		4. BUSHMEN'S BELT POUCHES	
Another use for belts	9	Pouches sewn on the belt	69
Selecting the lace	11	A 3-pouch belt	69
Cutting lace by hand	11	Pouch with a stud	72
The stabbed block guide	13	Pouch worn on the front	73
The split twig guide	14	Plaited knife pouch fixed to belt	74
Fingers only method	14	materials needed	74
Standard flat plaiting technique	15	Plaited knife pouch, loose	78
Eight plait	15	Standard knife pouch	81
Ten plait	15	Simple pouch	83
Twelve plait	15	Double pouch	83
Sixteen plait	15	Rabbit's pouch	84
Losing the sequence	16	Sailor's knife	84
Calculating the amount of lace	16	Plaited pouch	85
Twin ring belt	17	Watch pouch	91
Fourteen plait	19	Drop-down pouch	92
Eighteen plait	19		
Getting tension on plaited belts	20	5. LEATHER LACING	
Reversing the face	20	Whip stitch	94
Finishing off	22	Wide whip	95
The keeper	23	Mummy wrapping	97
Loose keeper	24	Back whip	98
Smoothing and stretching	25	Cross stitch	99
Buckle belt	25	Round braid	100
Fixed keeper	26	Single cordover	102
Plaiting patterns	27	Double cordover	103
Patterns in general	28	Triple cordover	105
Crocodile ridge plait	29	Lazy S	106
Raised edge plait	33	Dot stitch	108
Triple ridge plait	33	Baggin's stitch	108
Some variations	34		
Hat bands	36	6. PLAITS ROUND & FLAT	
Watch bands	36	Three plait	111
		Four plait(round)	111
2. BRAIDED BELTS		Crown knot	112
Round edge braiding	39	Double four plait	113
Single strand centre braid	40	Five plait(round)	114
Vine & flowers pattern	41	Six plait(round)	115
Twelve point braid	42	Seven plait(round)	115
Wide braiding	43	Eight plait(round)	116
Covered buckles	45	Eight plait(another method)	117
A braided snake	46	Twelve plait(round)	117
		Coachwhipping	117
3. THE SECRET PLAIT		Short whipping	118
Three plait	48	A dog lead	119
Eleven plait	48	Long whipping	121
Twenty-one plait	48	General rule for flat plaits	122
Allowing for shrinkage	49	Three plait(flat)	122
Three plait	49	Four plait(flat)	122
Five plait	52	Five plait(flat)	123
A dog collar	56	Six plait (flat)	123
A collar for a small dog	57	Seven plait(flat)	124
Another way to do three plait	58	Eight plait(flat)	124
Seven plait	60	Ten plait(flat)	124
Nine, eleven & thirteen plait	63	Twelve plait(flat)	125
Homemade gang cutter	64	Fourteen plait(flat)	125
Gulf knot	65	Sixteen plait(flat)	125
Trinity knot	66	A useful plaiting tip	125

## 7. WHIPMAKING PART 1

Basic stockwhips	126
Dimensions	129
Cutting the strands	130
Skiving	130
Rolling the belly	131
Avoiding tangles	132
Plaiting the whip	132
Plaiting soap	133
Attaching the fall	134
Rolling the whip	135
Making the cracker	135
Speeding up the job	136
Finishing off the cracker	137
Fastening the cracker	137
Making the handle	138
Attaching the keeper	138
Attaching whip & handle	139
Covering the handle	140
Forming the knob	141
Six plait whip	143
Working the six plait	143
Changing from 6 to 4	144

## 8. WHIP-MAKING PART 2

Kangaroo hide stockwhips	145
Materials needed	146
The core	146
The filler and belly plait	149
The bolster	150
The top plait	150
The top plait, greasing strands	155
Avoiding tangles	156
Broken strands	158
Joining without glue	158
A faster join	158
Changing from 12 to 10 plait	159
Changing from 10 to 8 plait	160
Changing from 8 to 6 plait	160
The fall	160
The handle	163
A half-plaited handle	168
French whipping	168
Appendix 1	172
Appendix 2 - All kangaroo hide whip	172
Appendix 3 - Cowhide belly	173
Appendix 4 - Whip from pre-cut lace	174
Making a bull whip	175
Snakewhip	180
Covering the knob	186

## 9. HOMEMADE TOOLS

Hole punch	189
Mallet	190
Stamps	191
Embossing tools	192
Cutting straps	193
Plough gauge	194
Edge shave	197
Edge crease	198
Wooden edge crease	200
Leather crease	200
Race	201
Marking wheel	203
Round knife	203
Lacing fid	204
Awl	205
Stitching awl	206
Bone smoother	207
Multiple slit punch	208
Edge polishing iron	208
Lace needles	209

## 10. ROLLING A THREAD

Sewing	213
Sewing thick leather	216
Another way of beginning	217
Back-stitching with one needle	218

## 11. SADDLE REPAIRS

Simple saddle repairs	220
Sewing the panel back	225
Repairing the tree	228
Replacing dees	230
Repairing a torn flap	231
Replacing girth straps	232
Seat breaking loose	234
Putting on a new seat	235

## 12. COUNTER-LINING STOCK SADDLES

Materials needed	241
Beginning the patching	242
Preparing to patch panel	242
Sewing back patch to back facing	243
Patch on panel edge	244
Sewing in channel material	245
Pinning patches in place	246
Stitching patches	247
Materials for counter-lining	248
Begin counter-lining	248
Concealed stitch	253
Serge sewn & filling begun	254
Filling top & bottom	255
Start of quilting	256
Using double ended needle	257
Using seat awl	258

1

# STOCKMENS' PLAITED BELTS





## STOCKMAN'S PLAITED BELTS

*by Ron Edwards*



## STOCKMAN'S PLAITED BELTS

*by Ron Edwards*



When I first printed the booklet on plaited belts I used a sketch of a stockman friend, Rob Cheerio, on the cover.

When it came time to print a

## STOCKMAN'S PLAITED BELTS

*by Ron Edwards*



## STOCKMAN'S PLAITED BELTS

*by Ron Edwards*



second edition I added a few years onto him, much to his disgust.

In later printings he has got older and older, until now he looks just about ready to retire.

## FOREWORD

Over the years bushmen have developed various crafts that are typically Australian, and one of these is the plaiting of kangaroo hide belts. Braided belts of various types are found in other countries, but the Australian variety is quite distinctive.

These belts are extremely comfortable, very flexible and immensely strong. Kangaroo hide is said to be the strongest leather in the world for its thickness, and yet is very easy to work with.

The stockman's belt evolved generations ago, probably in some isolated outback cattle camp during the wet season. At this time of the year when outside work becomes impossible the men repair harness and make up gear for the coming season. There is plenty of spare time to fill in, and so plaited work can be undertaken, such as the making of stockwhips, the best of which are also worked with kangaroo hide.

Belts are made in two forms, with a conventional buckle or with a pair of rings. The twin ring buckle is the most characteristic form, the rings usually being brass and from an old bridle. This style doubtless originated from necessity as there are usually a few bridle rings to be found around any station even when buckles are scarce.

Besides the use of kangaroo hide the stockman's belt also differs from other forms in the way that it is begun. In other parts of the world the usual custom is to begin a plaited belt from the buckle end, but stockmen begin from the point.

This may seem to be a little complicated the first time it is attempted, but after only a few belts it will be found to be relatively easy. Once the point has been formed the rest of the plaiting is quite simple.

## ANOTHER USE FOR BELTS

One day when I was doing some plaiting a bushman came along and told me an odd tale about plaited belts. He said that in the early days in western New South Wales and Queensland it was against the law for a swagman to carry a bridle amongst his gear. This was to discourage horse stealing.

To get around this problem the travellers would use two or three plaited belts to tie up their swag, and another around their waist, and with these they could soon put together a simple bridle using a scrap of fencing wire as a bit.

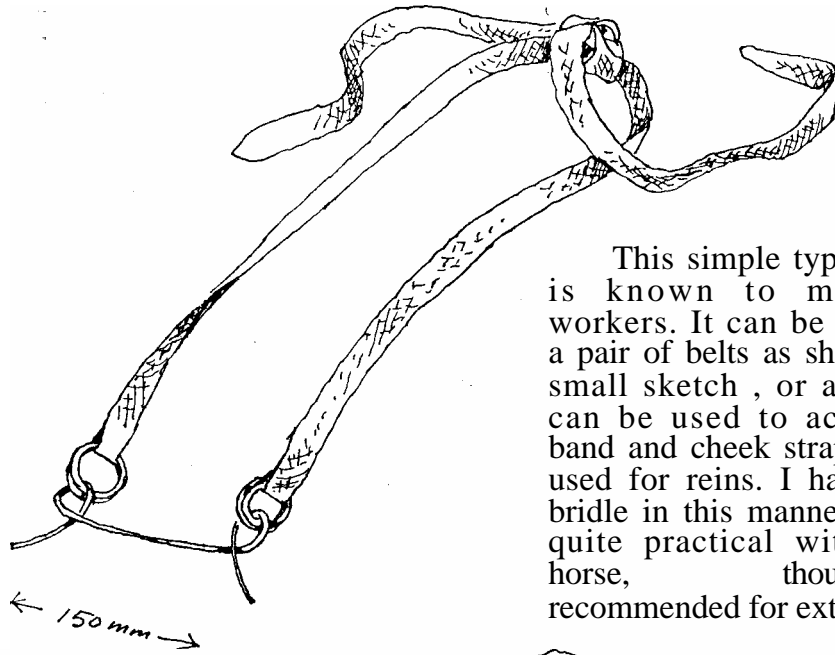

This simple type of bridle is known to most bush workers. It can be made with a pair of belts as shown in the small sketch, or a third belt can be used to act as brow band and cheek strap. Rope is used for reins. I have made a bridle in this manner, and it is quite practical with a quiet horse, though not recommended for extended use.



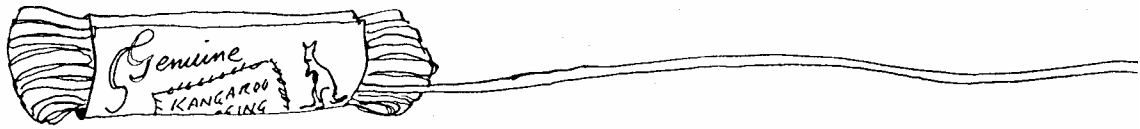

## SELECTING THE LACE

Kangaroo lace is usually sold by the hank, and at the present time is generally found to be labelled in a rather odd way, with the length being given in metric measurements but the width in Imperial. The average hank is either 11 or 23 metres long and comes in three widths, 1/8", 3/16" and 1/4". In time these will doubtless become 3mm, 4.5mm and 6mm.

The widest lace is not generally used for belts, being considered too wide, while the narrowest is only used by people with plenty of time on their hands. The middle width is generally chosen by people who have to do a lot of plaiting, though they concede that the narrow lace looks the best.

When choosing lace look for a good finish, uniform width and smooth edges. Reject lace that has a rough hairy back as this is inferior quality.

Without taking the wrapper off the hank locate one of the ends of the lace and give it a gentle tug. If you have selected the right end the lace will pull out from the hank in a continuous flow, and the whole hank can be used up without the wrapper being removed.

## CUTTING LACE BY HAND

In the bush most lace is still cut by hand, often using skins that have been tanned on the property .

The skin is laid on a bench and a circle is drawn on it, using a compass quickly made up with a nail, a piece of string and a pencil. The circle is then cut out.

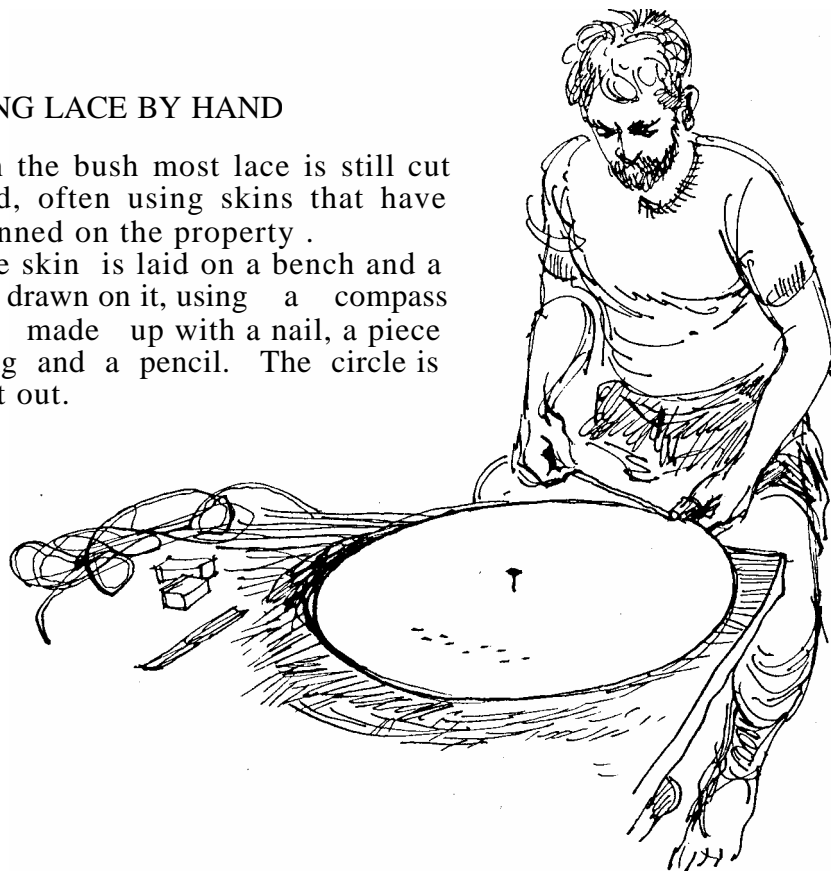

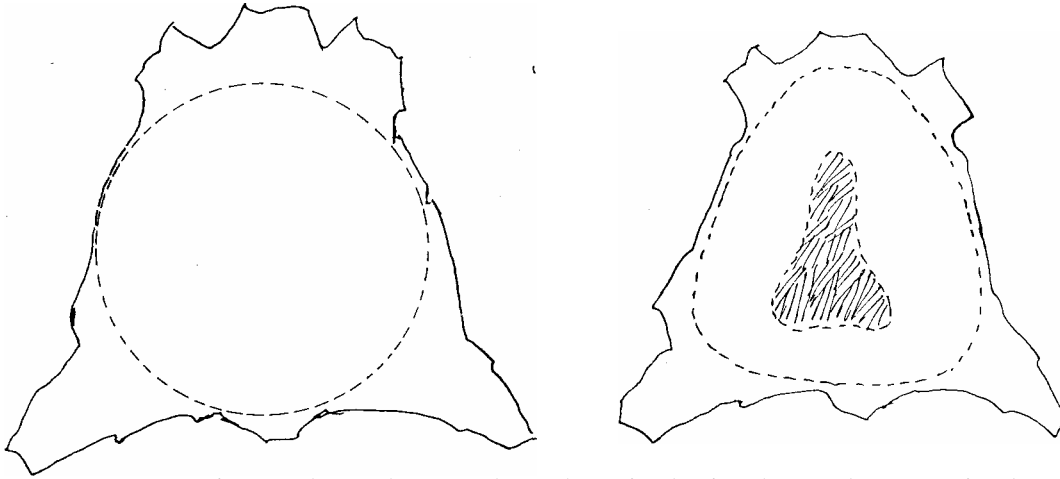

Experience has shown that the circle is the only practical shape from which to cut lace. If for instance a shape is cut such as that shown on the right in order to use up the maximum area of skin, then it will be found that a certain amount of distortion will take place on each revolution of the skin until one is left with a shape something like the shaded area in the centre which is quite impossible to work.

A circle however can be cut until only a coin sized piece remains. The trimmed parts are also not wasted, short lengths of lace can be cut from them, and items such as watch bands made from the smaller pieces.

The most convenient way to cut lace is with a special lace cutter made for the job. The only good lace cutter that I know of is distributed by stockmens' outfitters, R. M. Williams.

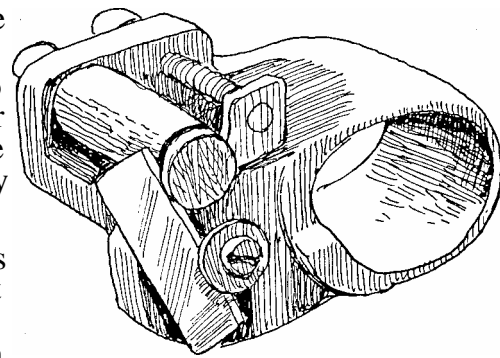

This ingenious small tool is made from iron and fits on the left thumb.

A piece of razor blade is used as a cutter, and a small screw on the top allows one to adjust the width to be cut, while the roller next to the blade is adjusted according to the thickness of the leather.

The circle of leather is fixed to the bench with a tack in the centre with the edge overhanging the bench a little on the operator's side. The first couple of centimetres of lace are cut with a knife and fed into the lace cutter.

As the newly cut lace is pulled from the cutter the leather circle revolves rather like a gramophone record. As the circle gets smaller it is necessary to re-position it from time to time.

The sharper the blade the easier it is to use, and we find it best to change the position of the blade or replace it after each skin.

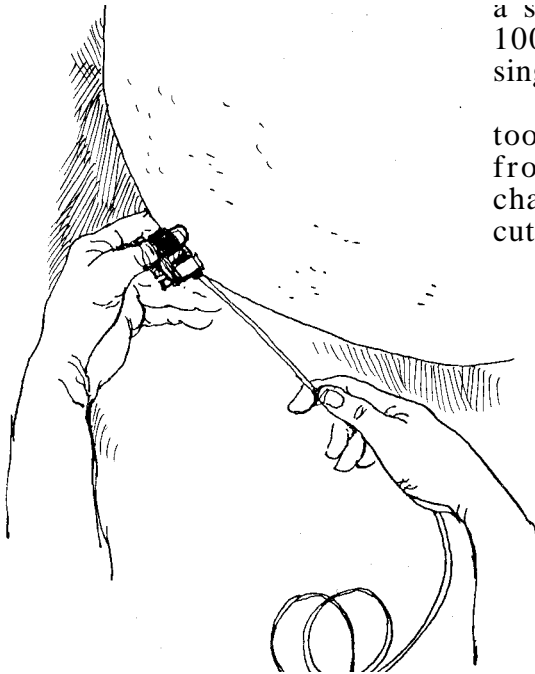

a skin will vary, but we often obtain 100 - 200 metres of 3mm lace from a single hide.

One secret when cutting with this tool is to pull the lace slightly away from the circle, this lessens the chance of the blade running off and cutting uneven widths.

In the outback lace is frequently cut entirely by hand or with a simple home made cutting guide. The essentials for this work are steady hands and a very sharp knife. I have watched a stockman sitting under a tree during the dinner break spend a full hour putting a good edge on his penknife, and my old ringer mate

'Slippery Sam' Callope would think nothing of spending two hours to sharpen a round knife.

For cutting lace the knife must be

sharp enough to readily shave the hairs on the arms, anything less and it is not worth beginning .

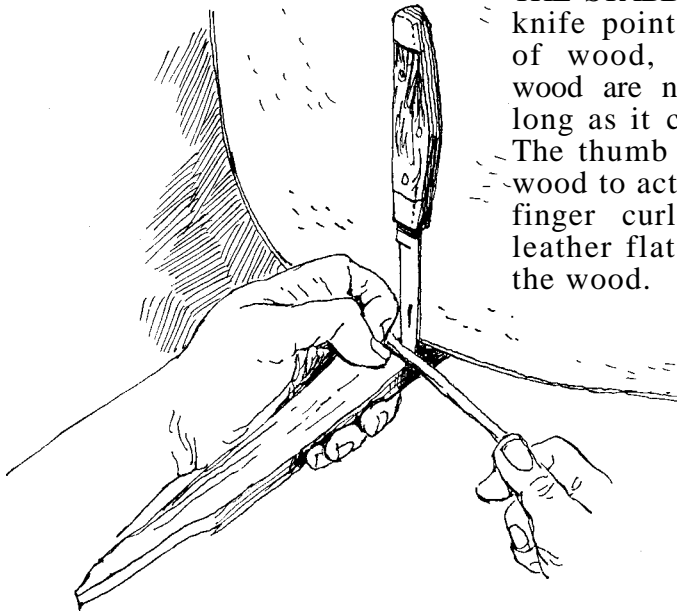

**THE STABBED BLOCK GUIDE** The knife point is driven into a block of wood, the dimensions of the wood are not important, just as long as it can be held in the hand. The thumb nail is pressed on the wood to act as a guide and the first finger curled over to keep the leather flat against the surface of the wood.

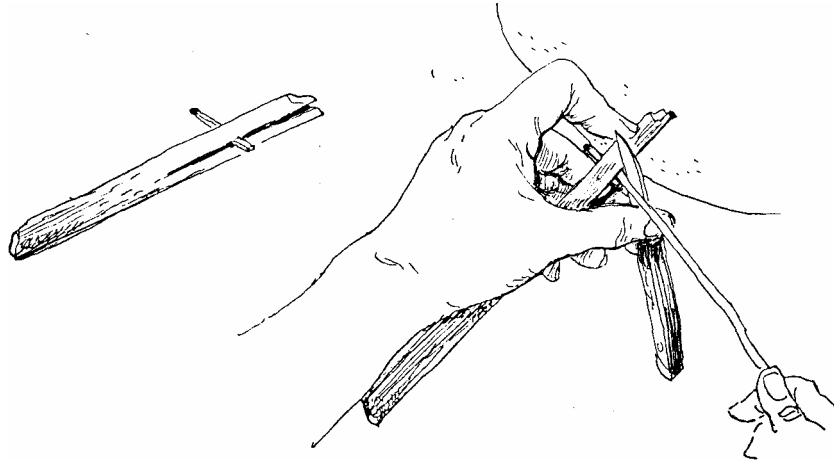

### THE SPLIT TWIG GUIDE

A stout twig is split and a match-stick put in to keep the split open. The match is trimmed down to the thickness of the leather to be used. The knife is held as shown in the sketch, this takes some practise, and the base of the handle is usually kept steady by resting it on the knee. The lace passes between the blade and the match-stick.

### FINGERS ONLY METHOD

Whip makers often trim leather entirely by hand without any form of guide, and each man evolves his own style. One man's technique may be of no use to another.

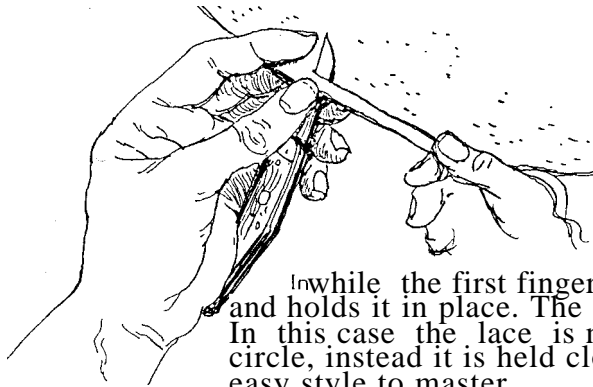

In the sketch the inside edge of the thumb nail is being used as the guide while the first finger sits on top of the leather and holds it in place. The other fingers hold the knife. In this case the lace is not pulled away from the circle, instead it is held close against it. This is not an easy style to master.

This is the cutting method shown to me by Lindsay Whiteman of Townsville. Sit down and put the hide on the bench. The thumbnail of the knife hand acts as a gauge while the other hand pulls the lace.

The knife needs to be extremely sharp to use this technique.

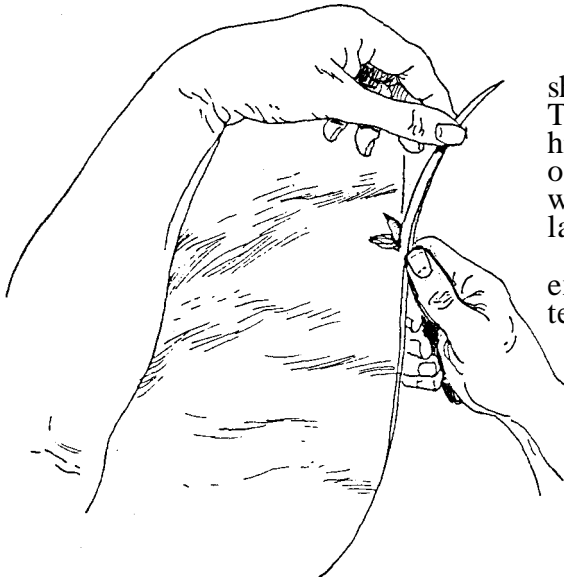

## STANDARD FLAT PLAITING TECHNIQUE

Many beginners do not realize that the standard flat plait technique is the same whether it be a 4 plait or a 24 plait. This is illustrated in the sketch which shows the most common plaits used in belts, 8, 10, 12 and 16. Note that each is formed in the same manner.

It is best to develop the habit of always beginning on one side - left or right as you prefer. The main thing is to establish a regular working pattern. I always begin on the left.

Eight plait

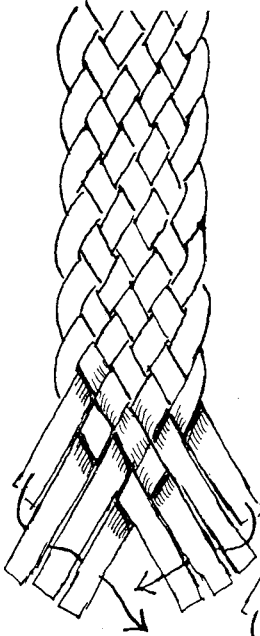

Ten plait

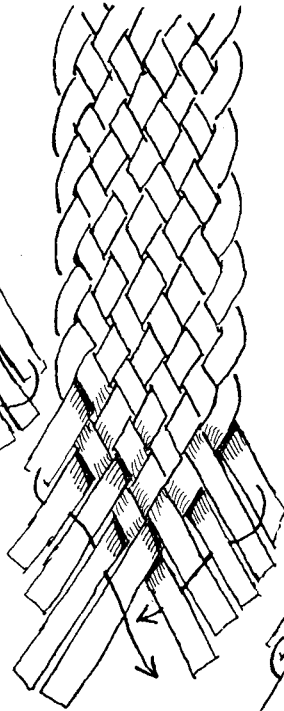

Twelve plait

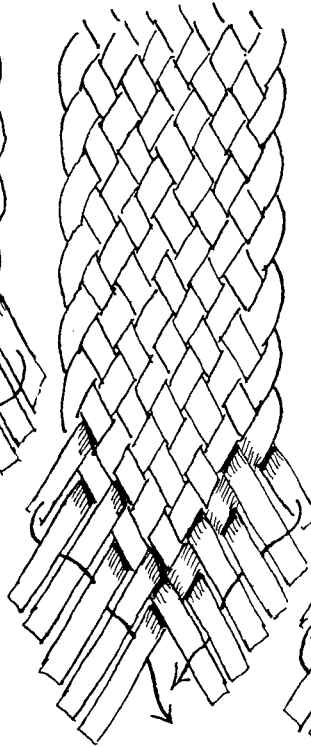

Sixteen plait

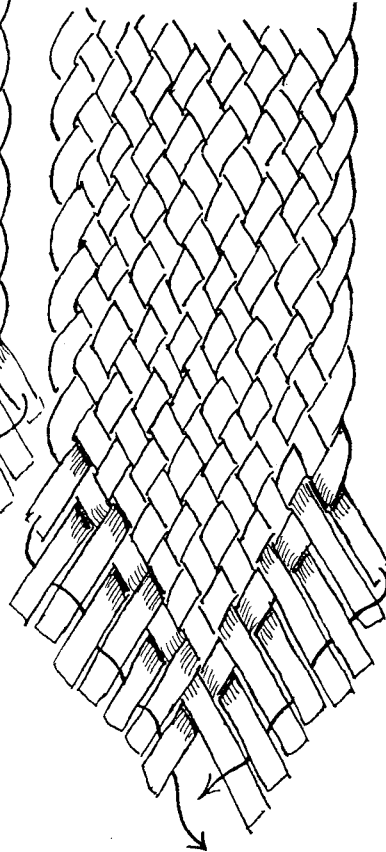

15

Notice that in every case the left hand lace goes under-over-under-over and so on until the middle is reached. The right hand lace is then brought across in an over-under-over-under sequence.



## LOSING THE SEQUENCE

If a belt has been put aside for some time you will have forgotten which strand is the next to be worked, and this is where the practise of always beginning from the left pays dividends.

Count the strands in each hand, if they are equal then begin by bringing the left strand across. If there are more in the right hand than the left then bring one across from the right.

If there are more in the left hand than the right then you have got out of sequence somewhere. Keep on bringing strands down from the left until you have the same number in each hand. Now begin the sequence by bringing down one from the left and then one from the right.

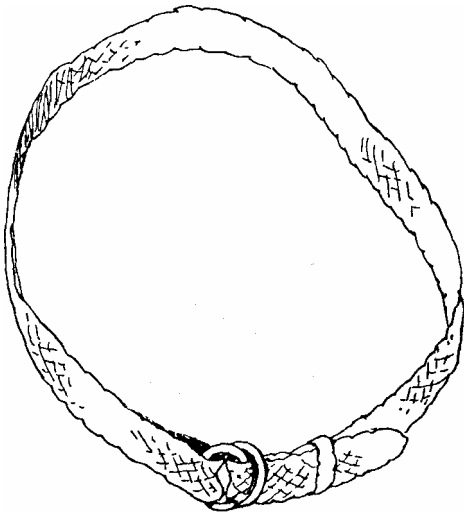

## CALCULATING THE AMOUNT OF LACE NEEDED

There are a number of things to consider when calculating the length of lace needed for a belt. Beside the waist measurement there is extra lace needed for fastening on the rings or buckles, and there is also the question of how much length is going to be lost in the actual plaiting.

Also remember that you double your lace, in other words you use 5 strands to make a 10 strand belt.

There is a simple method of working out the length of lace needed. Take the person's waist measurement and multiply it by 3. The scale below gives the person's waist measurement, the number of strands to cut and the length of the strands.

Waist measure	6 plait	8 plait	10 plait	12 plait	16 plait				
500 (19½")	Cut 3 strands	Cut 4 strands	Cut 5 strands	Cut 6 strands	Cut 8 strands				
600 (23½")						1500	1500	1500	1500 (4'11")
700 (27½")						1800	1800	1800	1800 (5'10")
800 (31½")						2100	2100	2100	2100 (6'10½")
900 (35½")						2400	2400	2400	2400 (7'9½")
1000(39½")						2700	2700	2700	2700 (8'10½")
	3000	3000	3000	3000	3000 (9'10")				

This calculation takes care of the extra lace needed for the three points listed above. Measurements in millimetres.

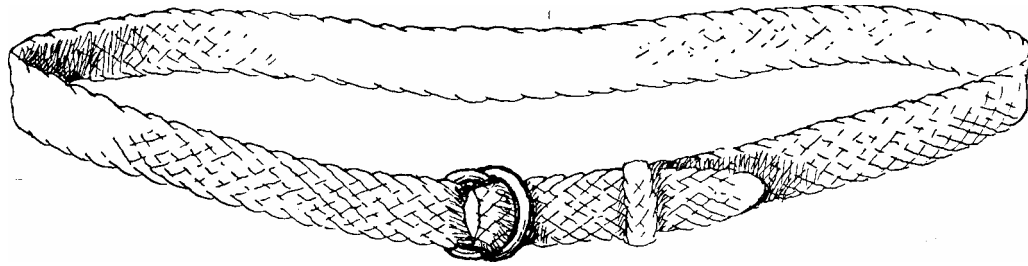

The twin ring belt is a real bushman's belt. Instead of using a buckle it is fastened with a pair of rings, usually brass rings from a bridle.

The first step in making a belt is to calculate the length required as explained above. Let us suppose that you have measured the waist as one metre and you wish to make an 8 plait belt. To do this you will need 4 lengths of lace each 3 metres long.

For the beginner the best plan is to put a nail into the top of a bench or table and form the point of the belt around this. Once you have made a few belts you will find that this is no longer necessary, and the point of the belt can be formed while holding all the lace in the hand.



16

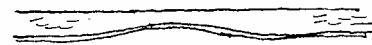

17

The sketches show the beginning of an 8 plait belt. To do a 10, 12 or 16 simply add in more strands as desired. The first strand of lace is looped around the nail, making sure that the good side of the leather is facing upwards all the way around. If the leather is very thick it may help to thin it a little just at the point as shown in the sketch, but this is not generally necessary.

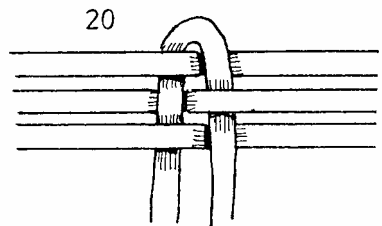
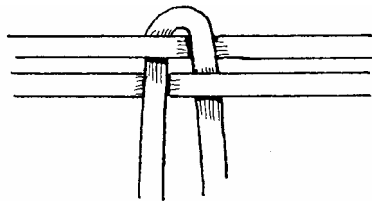
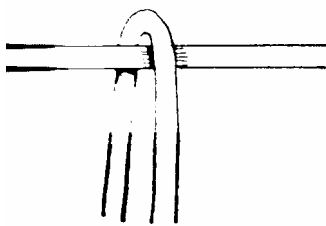

1  
9

20

The other strands are now added in as shown.

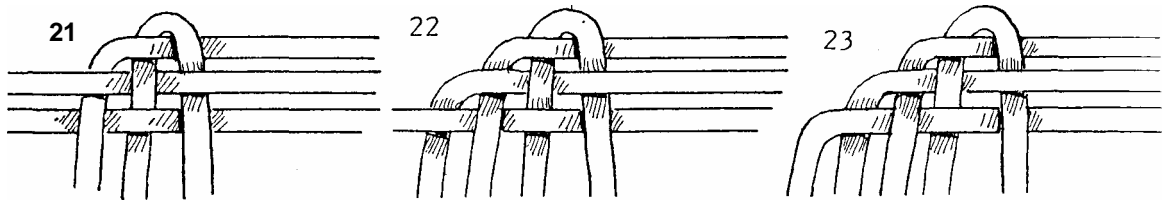

Beginning on the left side at the top turn down all the strands in an under-over-under sequence.

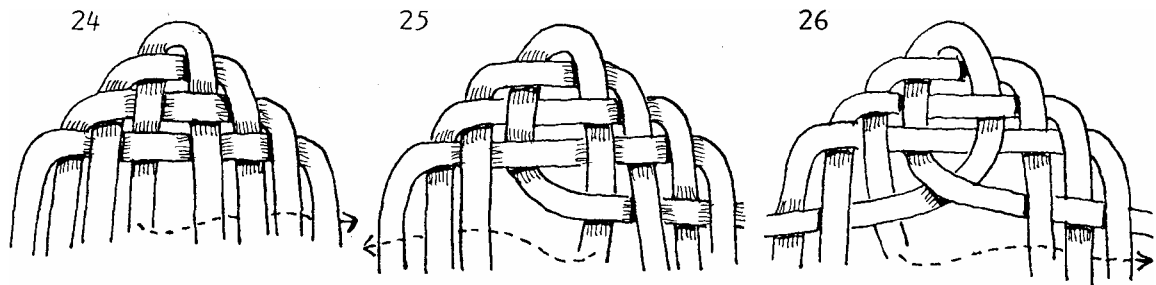

The right side is then turned down in the same way. Now the centre left strand is moved across as shown by the dotted line, then the right side inner strand is brought across as shown in the next drawing.

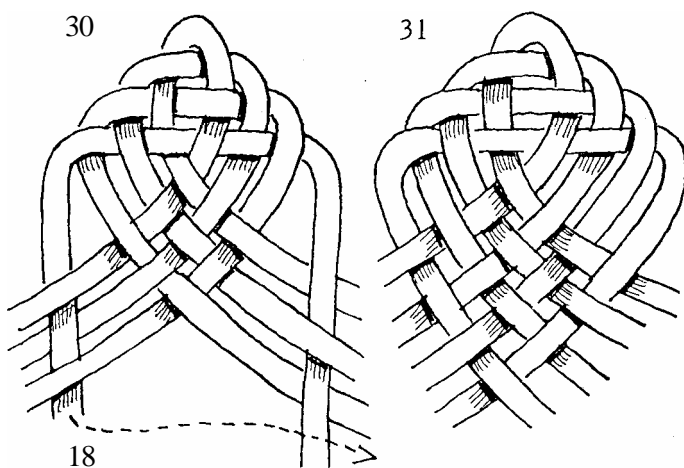
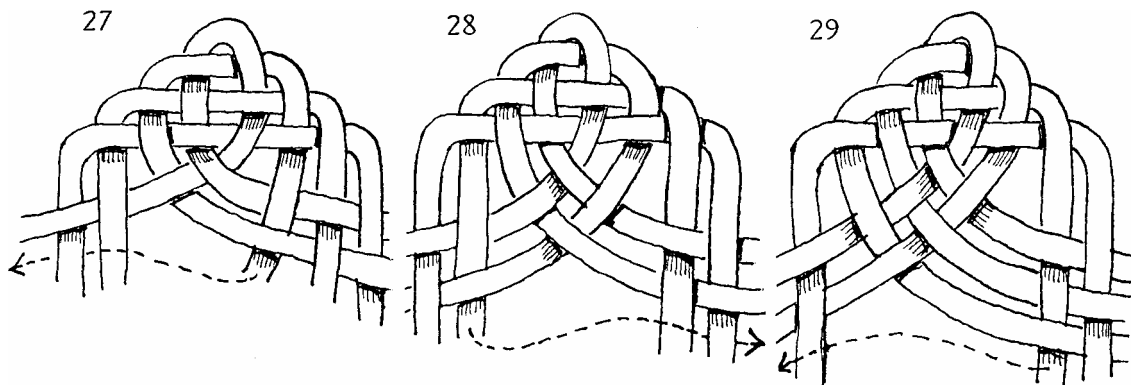

Each strand is brought over in sequence. Once this has been done the work can be removed from the nail and carefully pulled firm to make the point of the belt.

Once the point has been shaped the plaiting of the belt can go ahead. Beginning on the left the outside strand is brought to the centre as indicated by the dotted line. Then the right hand outside strand is brought to the centre.

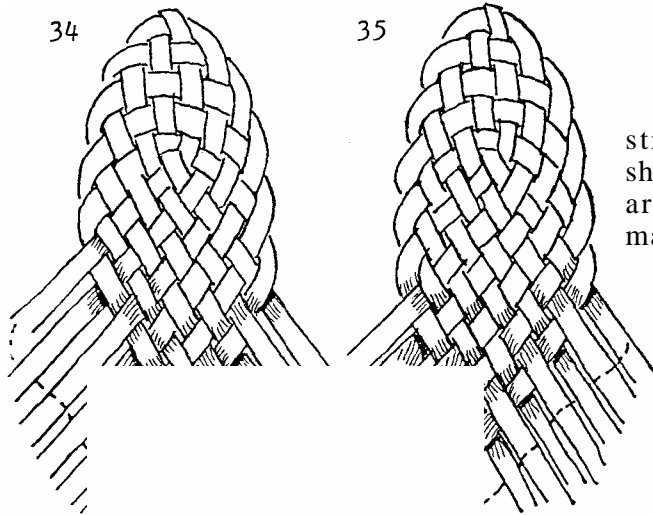
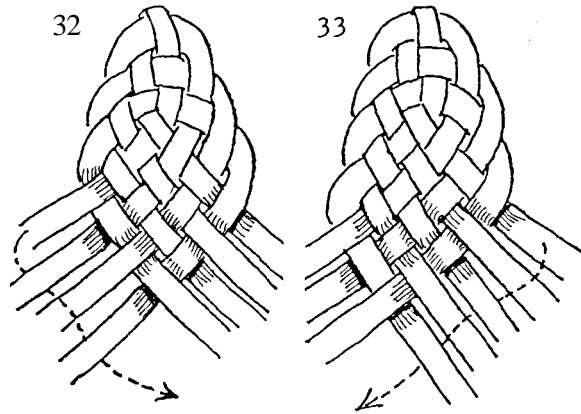

Here is a sketch of a 12 strand plaiting sequence to show that the same basic steps are followed no matter how many strands are used.

**FOURTEEN STRANDS**

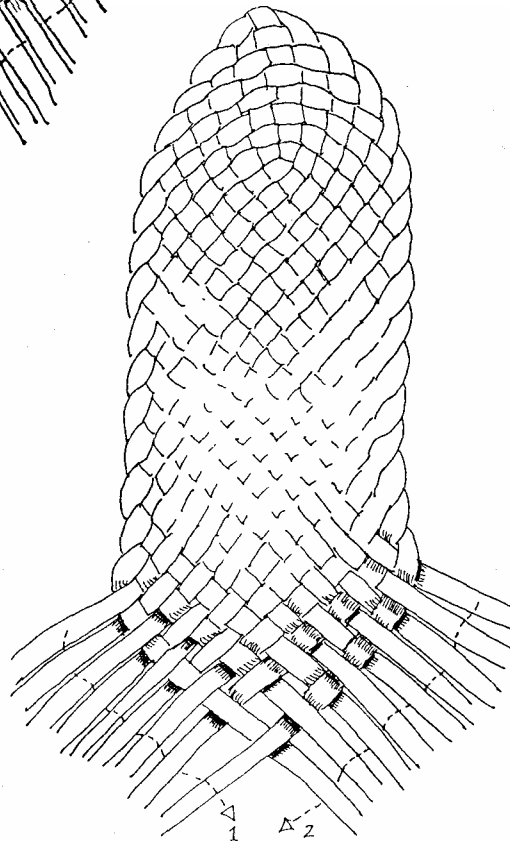
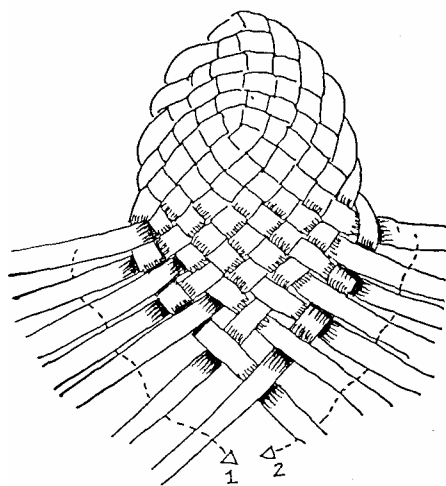

**EIGHTEEN STRANDS**

## Getting Tension on Plaited Belts

I have found the main thing is to get the end of the belt fixed firmly to something while you are plaiting.

Some people put a wire hook through the belt to hold it, but I do not like this as it can stretch the belt at this point and leave a hole.

It is also possible to put the end of the belt in a drawer and close the drawer. This jams the end of the belt and holds it firm.

I prefer to hold the end of the belt with a length of soft cord. This can be moved down as work proceeds and does not mark the leather in any way.

First, he rubs the lace with mutton fat or leather dressing before working with it, and says that this helps get a tighter plait.

He also tightens up the strands as illustrated. The top strand is pulled tight only when you are about to work with it, but the working through is left loose. He claims that this gives a much more even finish.

pull  
tight  
then  
work

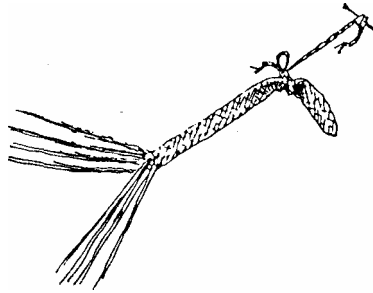
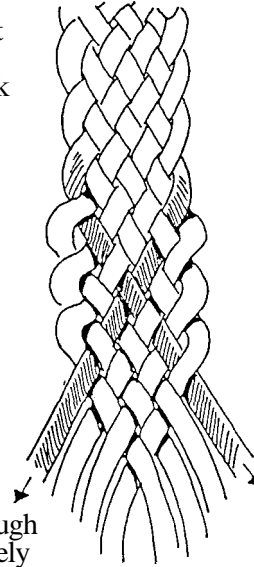

Lindsay Whiteman, a plaiting expert from Townsville, Qld, also passed on a couple of hints for tting an even tension.

36

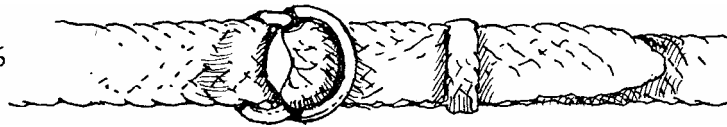

### REVERSING THE FACE

The twin ring belt is fastened as is shown in fig.36. If special steps were not taken then the point of the belt would now be showing the rough side of the leather facing outwards. To avoid this the whole face of the belt is reversed. This is illustrated in fig. 37, the shaded section representing the rough side of the leather.

37

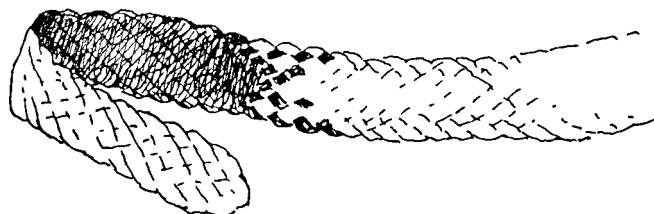

Reversing begins when 140 mm of belt has been plaited.

There is no change in the plaiting sequence, but as each strand is picked up it is given a twist as shown in fig. 38 so that the rough side of the leather is now showing.

Once all the strands have been reversed plaiting continues as before until the belt is completed.

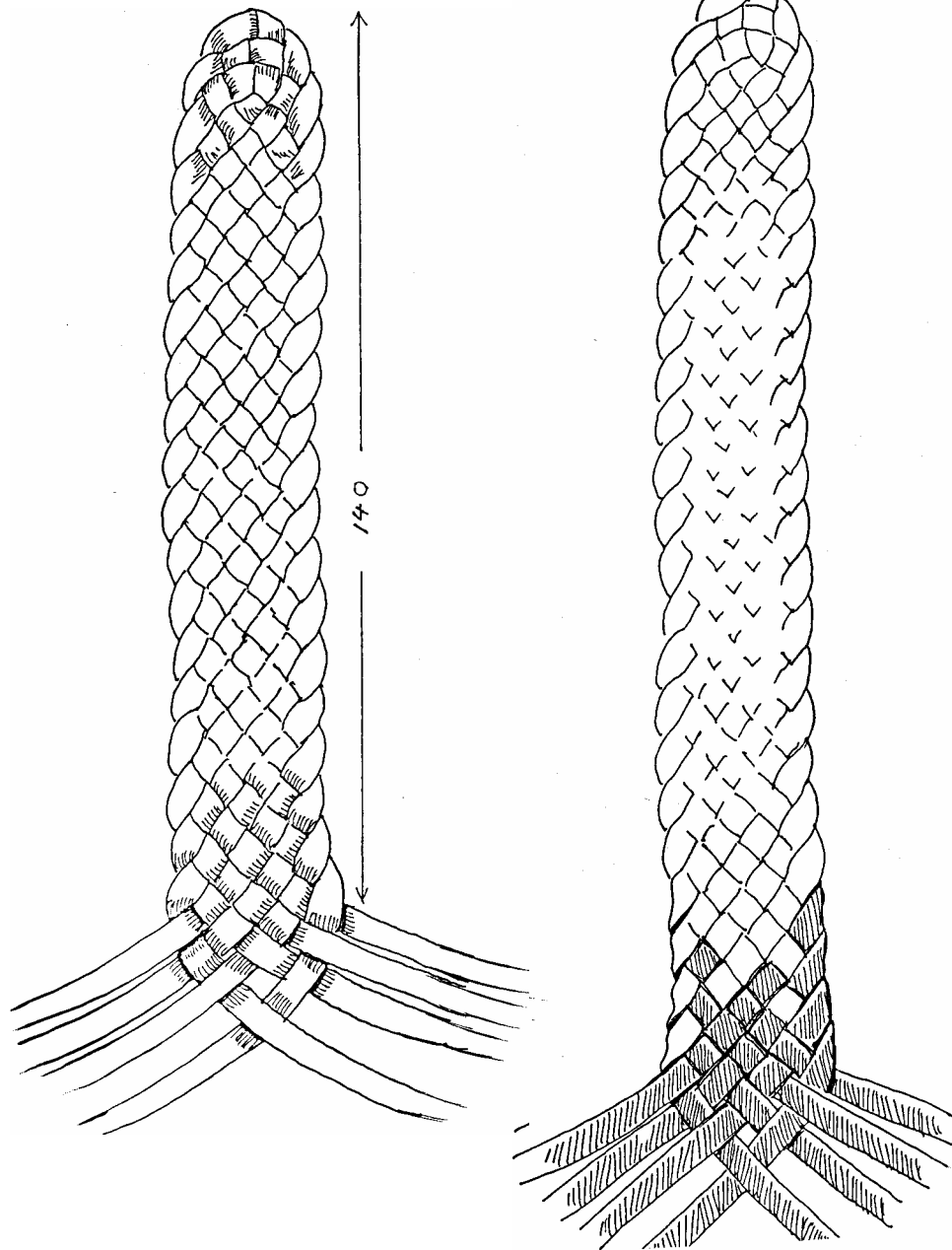
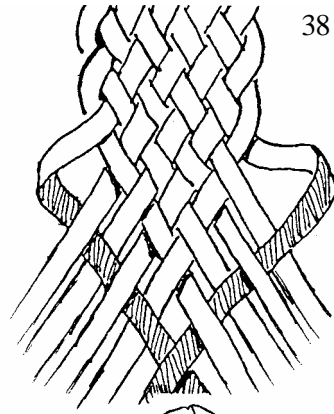

### FINISHING OFF

When the wanted length has been plaited, slip a pair of rings over the end of the belt. Solid brass rings look better than plated ones, and they look better if they make a neat fit and are not too large in diameter.

Turn the belt over and tuck in the two ends as shown in fig 40\*. Now the remaining loose strands can also be tucked in, following the pattern of the strands below.

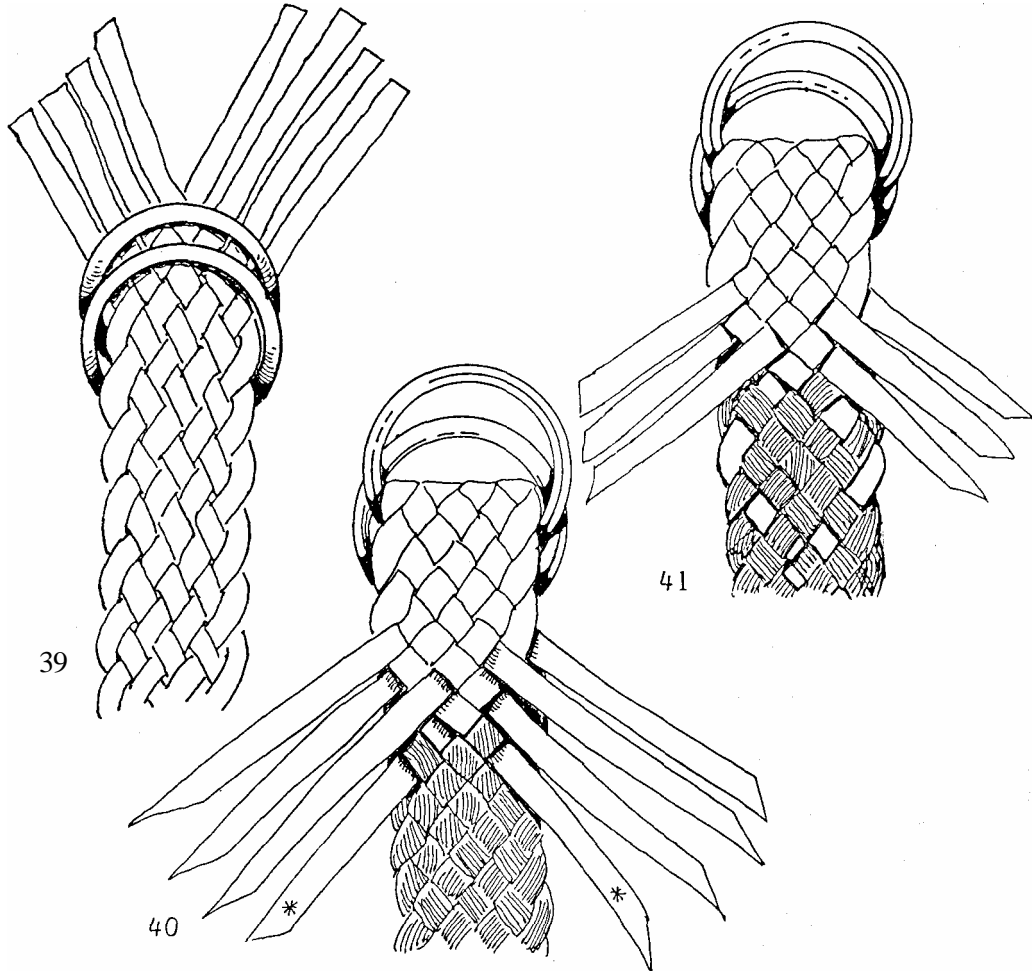

When sufficient length has been plaited back to firmly secure the rings the ends are trimmed off.

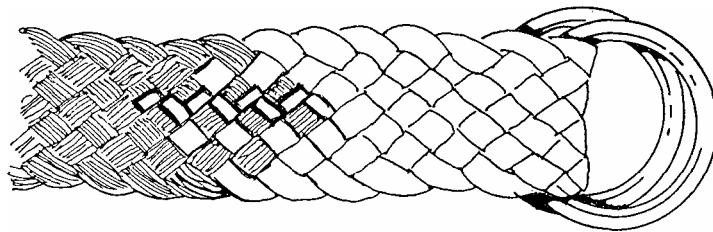

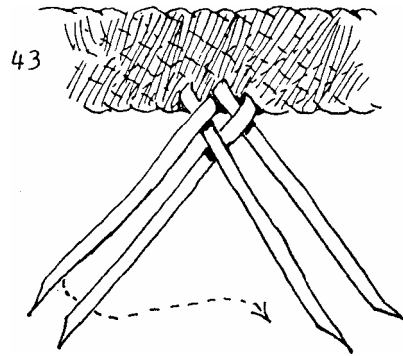
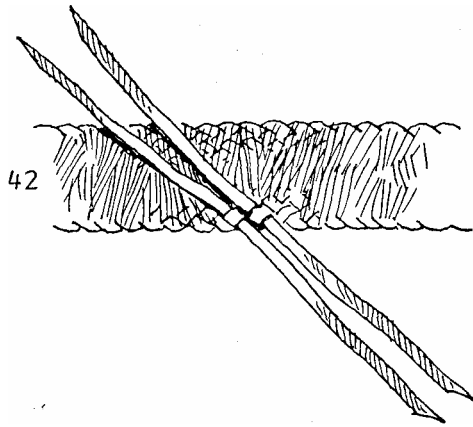

### THE KEEPER

A keeper is now needed to hold the loose end of the belt neatly in place. The keeper can be loose or plaited permanently into the belt. The latter is best as loose keepers are easy to lose.

A fixed keeper is made by slipping two scraps of lace into the belt about 190mm from the point. This is done on the back of the belt. These are then folded as in fig. 43 so that the good side of the lace is facing you.

An ordinary 4 plait is commenced as shown in the sketches.

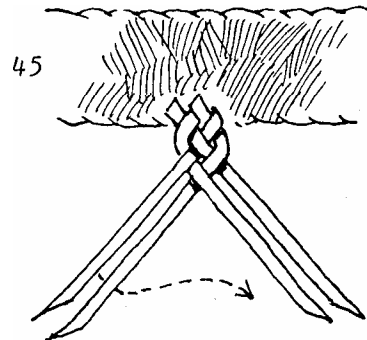
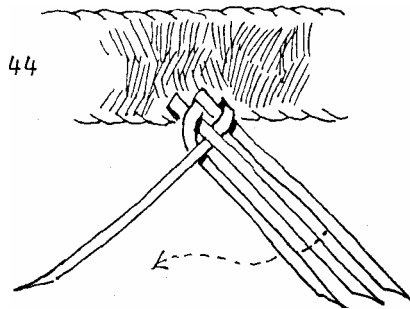

The belt is turned over so that the keeper goes across the front of the belt as in fig. 46.

The end is plaited into the back of the belt as shown in fig.47, and plaited in far enough to make it firm.

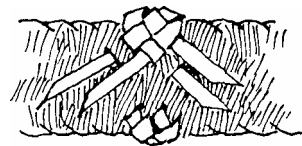
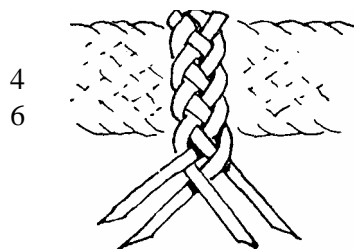



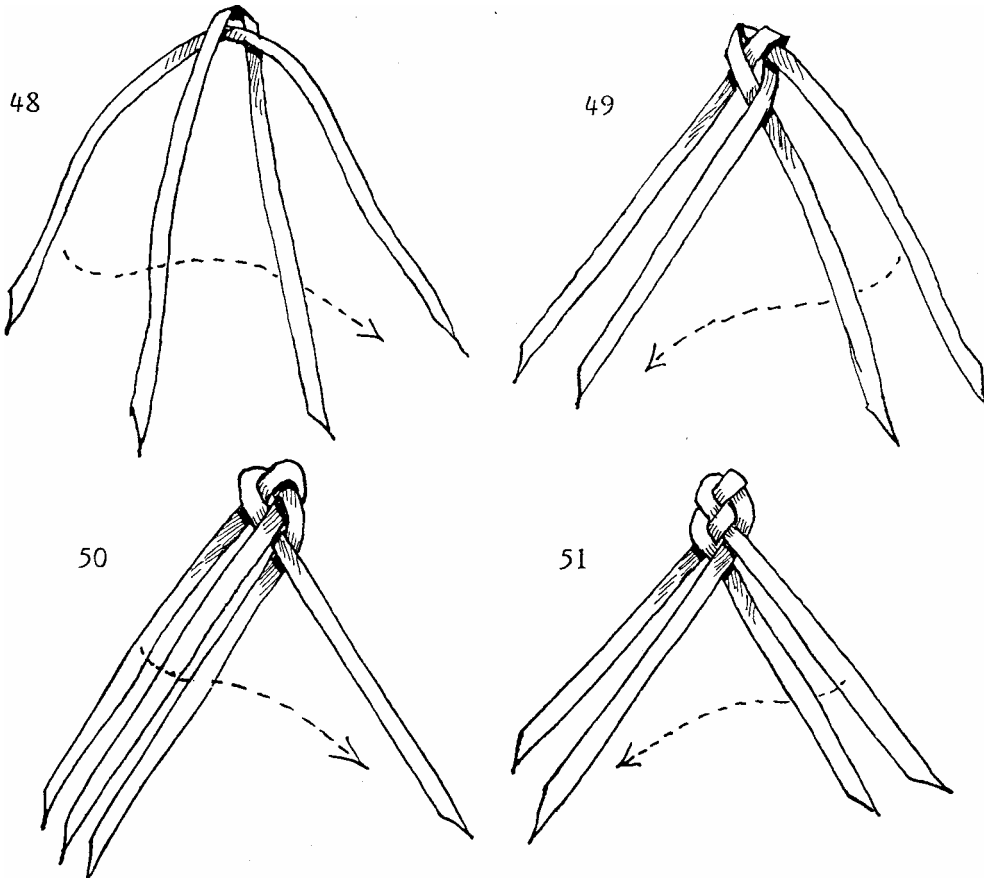

### LOOSE KEEPER

A loose keeper can be made in a few minutes if these steps are followed. Take two scraps of lace and fold them together as shown in fig. 48. The good side of the lace is facing up.

Now follow the sequence shown by the dotted lines. When sufficient length has been plaited form a loop and work the strands in as shown in fig. 52. Work the strands in far enough to make them firm then cut off the surplus.

If the beginning of the plaiting forms an undesirable lump inside the loop then this can be trimmed off as well, but this is not usually necessary.

There are other methods of beginning a loop, but this is the quickest and easiest.

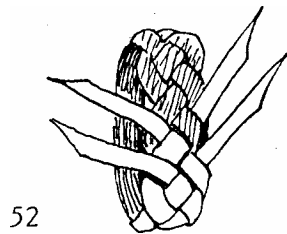

52



53

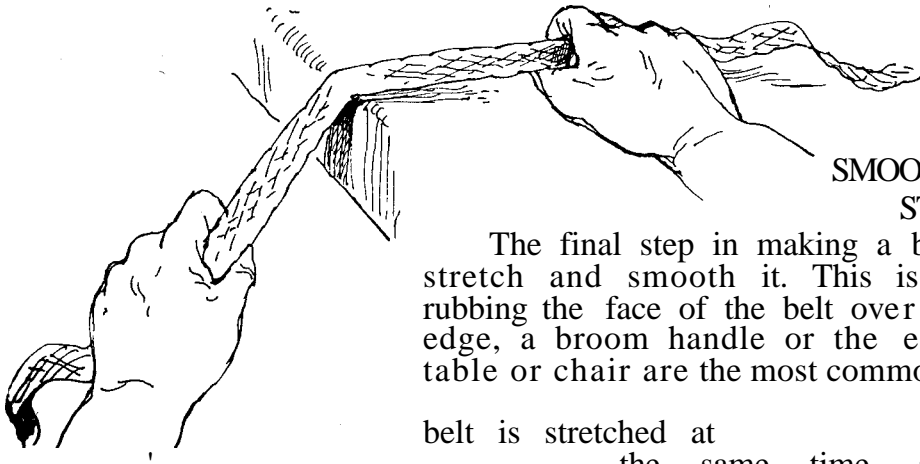

## SMOOTHING AND STRETCHING

The final step in making a belt is to stretch and smooth it. This is done by rubbing the face of the belt over a smooth edge, a broom handle or the edge of a table or chair are the most commonly used.

The

belt is stretched at

the same time, and this treatment tightens up the plaiting and smooths down the surface at the same time.

If the belt needs polish then Dubbin or boot polish are best. However in the bush saddle dressing is more usually applied, and this is quite satisfactory, though it does not bring up a high polish.

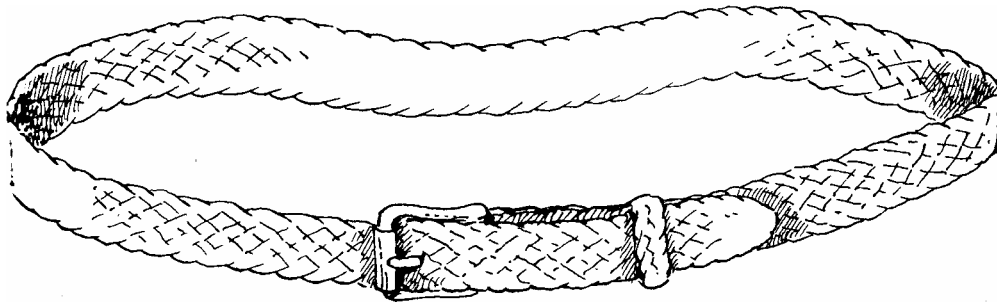

While the twin ring belt is the most characteristically Australian style of belt the use of buckles is also common. Plain brass full swage bridle buckles are often used, or any other readily available harness buckle, such as brass girth buckles.

Holes are not punched in the belt to take the tongue of the buckle, it is simply pushed through the weave. However some commercially made belts do have eyelets fitted to them, a quite unnecessary feature.

The belt is plaited in the same way as described earlier, except that the lace is not reversed at the point end. The good side of the lace faces upwards for the whole length of the belt.

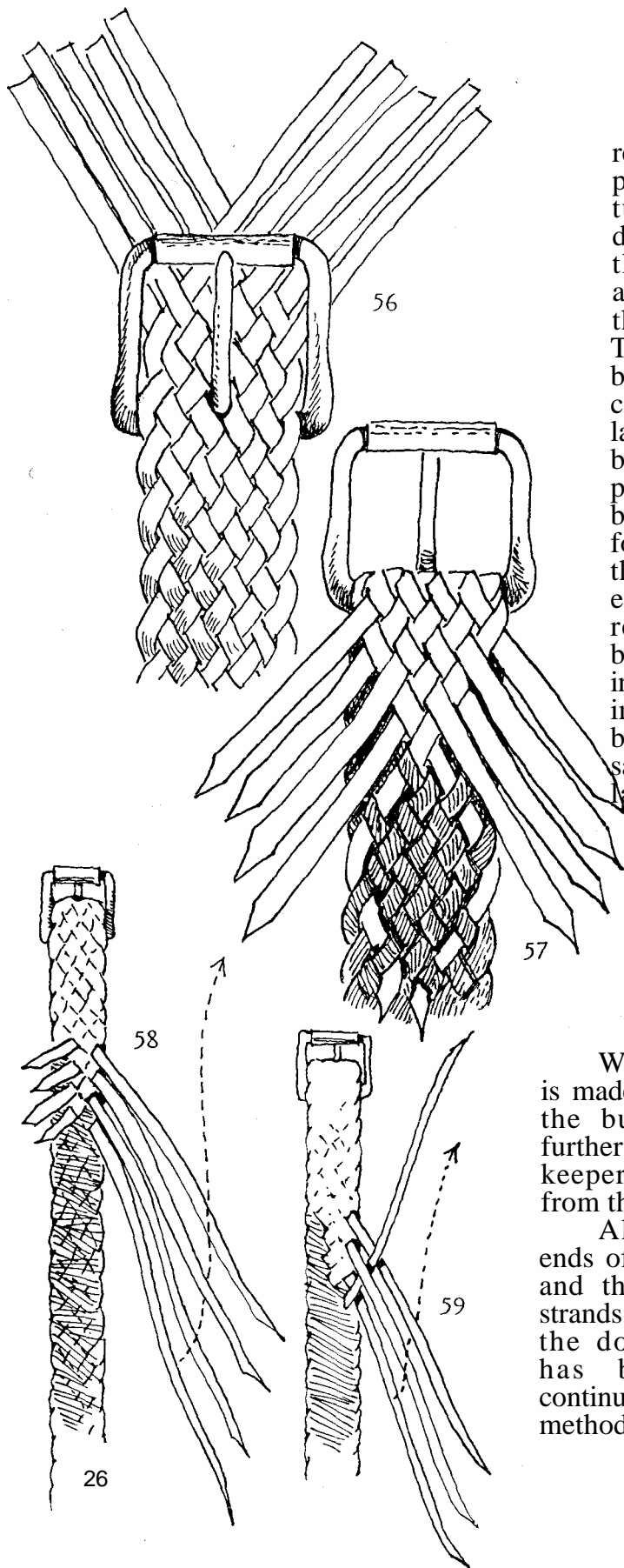

When the end of the belt is reached the buckle is slipped in place as shown in fig.56, the belt turned and plaited back as described earlier. Fig. 57 shows the first two laces plaited back, and the other strands are worked the same way. **FIXED KEEPER**

The keeper for a buckle belt can be made as described earlier, or it can be worked up from the surplus lace left when plaiting has been completed. When skilled plaiters use this method they begin the plaiting of the belt with four strands about 150mm longer than the rest. By doing this they end up with four long strands all ready to use for a keeper when the belt has been completed, as shown in fig. 58. This is not so important on an 8 plait belt, but on a 16 plait it means a saving of nearly 2 metres of lace.

When this type of keeper is made the plaiting back from the buckle extends a little further than usual so that the keeper will be about 80 mm from the buckle.

All the other unwanted ends of lace are trimmed flush and then the four remaining strands are placed as shown by the dotted lines. Once this has been done plaiting continues. (see figs. 46-47 for method of finishing).

## PLAITING PATTERNS

The majority of stockmen prefer a plain belt, but patterned belts are not uncommon. Some plaiters prefer a subtle effect, using light tan and mid tan lace, while others strive for a more dramatic effect using the lightest colours against the darkest available. The sketches show the most popular patterns.

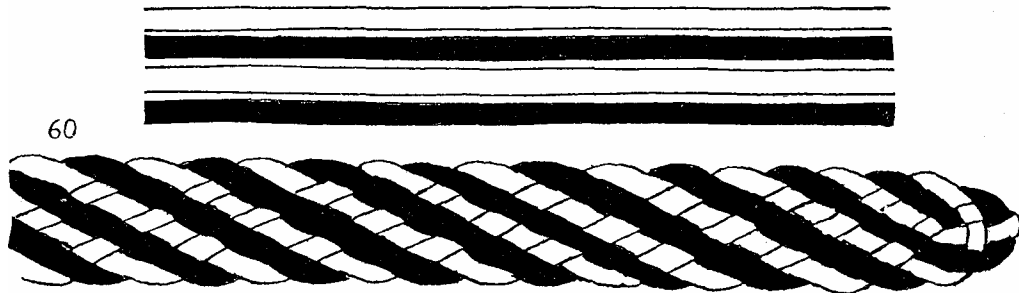

Fig. 60. By alternating the strands a striped effect is created.

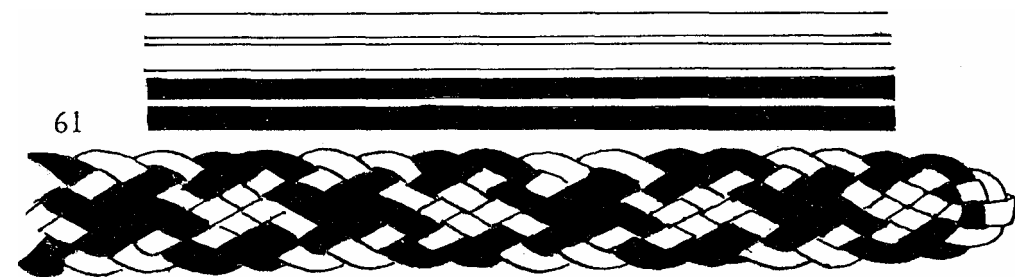

Fig. 61. By dividing the colours into two bunches a broken pattern is created. On a 12 plait belt using light tan and mid tan a pattern is produced that looks something like snake skin.

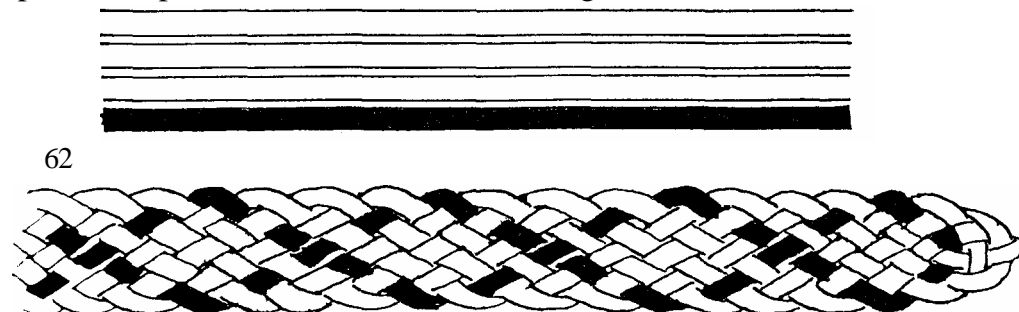

Fig. 62. When only a single coloured strand is used a diamond pattern runs the length of the belt. In this case the single strand is dark.

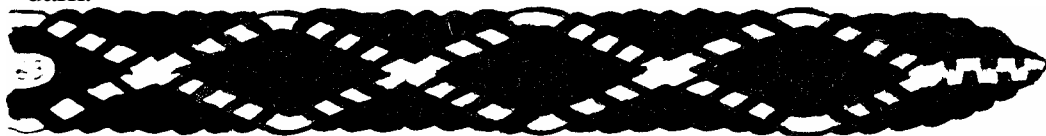

Fig. 63. When the single strand is light a more striking pattern of diamonds is created.

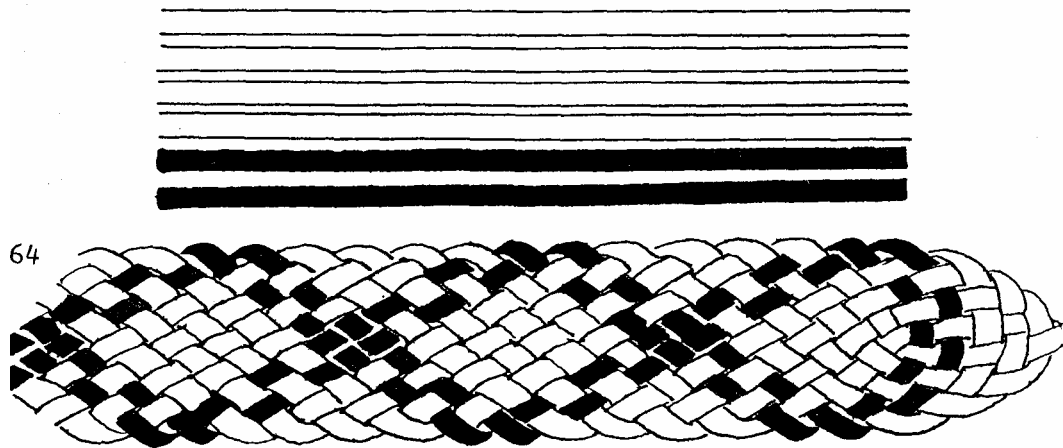

Fig.64. The more strands used in the belt the more the pattern can be altered, as in this example of a 12 plait.



Fig.65. It is possible to alter the pattern in the course of plaiting, but this is not often done as there is usually a rather messy section where the patterns change over. In this case the belt has begun as in fig.60.

Then gradually as plaiting continues one strand is crossed over the other until all the light strands are in one hand and all the dark ones in the other. Now a totally different pattern is created.

In order to avoid the confused area where the patterns change over some plaiters cut the strands and glue on strands of the desired colour, and can thus change the pattern instantly. Whip makers often use this technique.

#### PATTERNS IN GENERAL

Although a variety of patterns can be created by changing the colour of the lace as work proceeds most plaiters prefer to use the basic patterns given above. In general they use subdued colours, usually light, middle and dark tan.

When brighter colours are chosen they are almost always on the warm side of the spectrum, dark red, warm yellow and so on. Blues and greens are avoided.

The mixing of three or more colours is also frowned on, unless they happen to be all shades of tan.



Fig.66. This pattern is created by making one half of the lace a darker colour than the other or by joining together dark and light lace. The glue used for joining the lace does not have to be anything special as long as plenty of overlap is used, for the plaiting will hold the lace firmly in place.

If the lace is glued it is a good idea to do the gluing off centre, (the dotted line represents the centre). Not only does this allow the point of the belt to be a solid colour but it avoids the likelihood of a glued section getting scuffed apart at the point of the belt.

Beginning with all the dark strands in one hand and all the light ones in the other an interesting pattern is created.

By changing to a crocodile ridge plait, as described in the following section, the belt will be divided into two bands of solid colour as shown.

### *Crocodile Ridge Plait*

The crocodile ridge is a distinctive form of



plaiting in which a ridge is formed down the centre of the belt. When this is well done it resembles the ridges along the back of a crocodile.

There are a number of ways of forming this ridge, but I will describe the one most commonly used by bush plaiters.

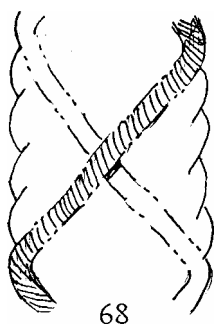

68

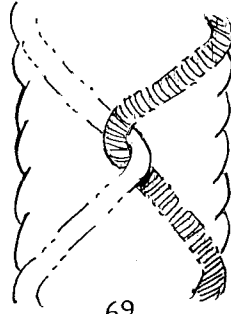

69

## Crocodile Ridge Plait

The basic principle of forming the ridge is shown in figs. 68 and 69. Fig.68 shows the normal plaiting technique in which the strands go from one side of the belt to the other.

Fig. 69 shows the crocodile ridge. Notice that the strands do not go from side to side but instead meet in the middle and then go back to the same side. Where the leather wraps around the strand from the opposite side it buckles up a little, and this forms the distinct ridge down the centre of the belt.

It is not convenient to run a crocodile ridge the entire length of a belt as the ridge would interfere with the belt slipping through the buckle, and so the belt is begun and ended as an ordinary flat belt as described earlier.

Some plaiters do the flat plait and then go directly into the crocodile ridge, but this is a poor practice as the belt will be seen to narrow at this point. A well made belt will introduce an extra strand for the length of the ridge and so keep the belt a uniform width.

Fig.70. Having plaited at least 200mm of ordinary plaiting an extra strand is folded in as shown.

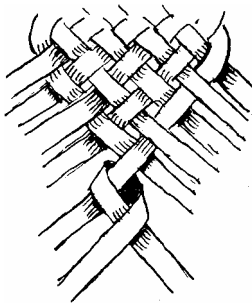

70

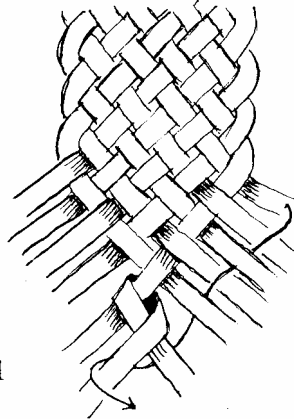

71

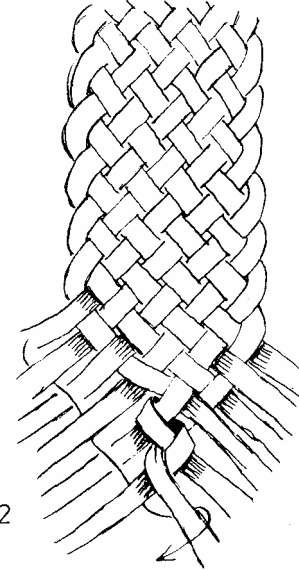

72

Figs 71 & 72. The outside strands are brought across as shown. Note that the strands are only bent in the centre, they are not twisted over in any way.

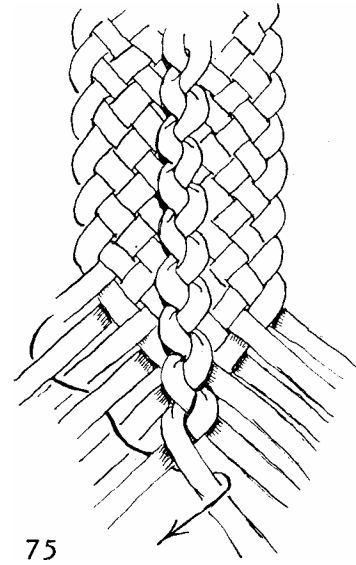
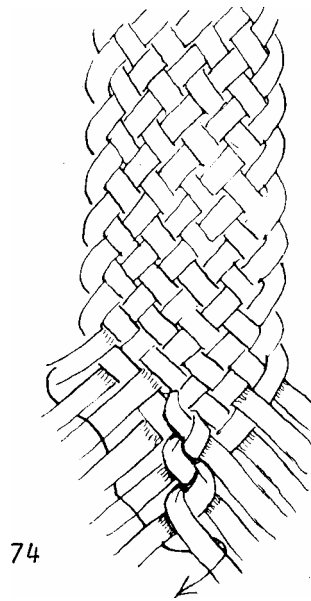
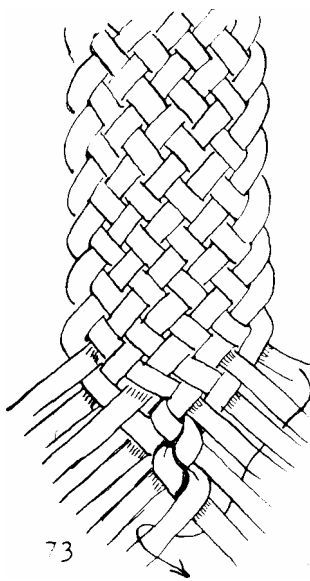

Figs 73 - 76 This shows the basic method of working the ridge.

Before the buckle end of the belt is reached ordinary flat plaiting is resumed, and so the two ends of the extra strand must be hidden. Fig.77 shows how the left strand comes across and goes beneath the centre strand.

Fig. 78 shows the right strand coming across and sitting on top of the centre strand.

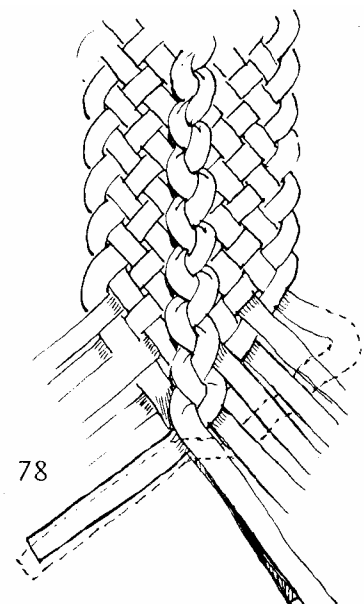
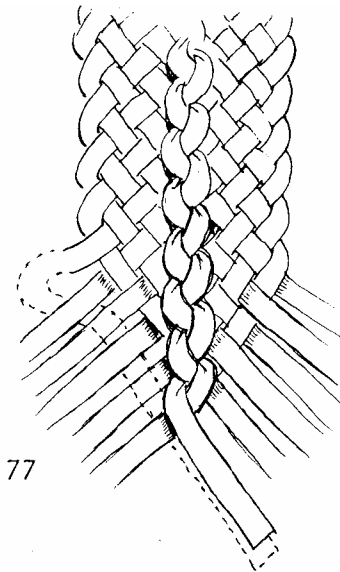
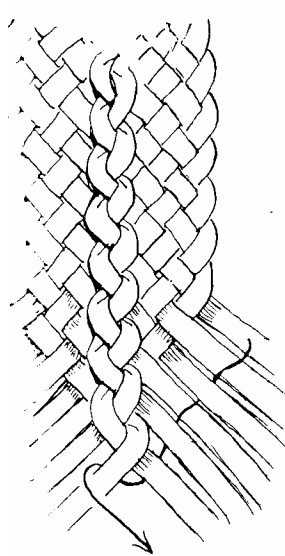



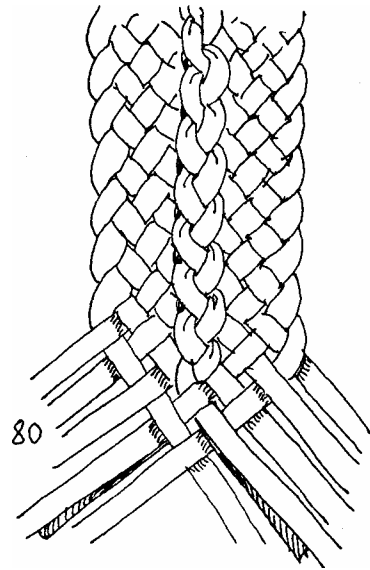
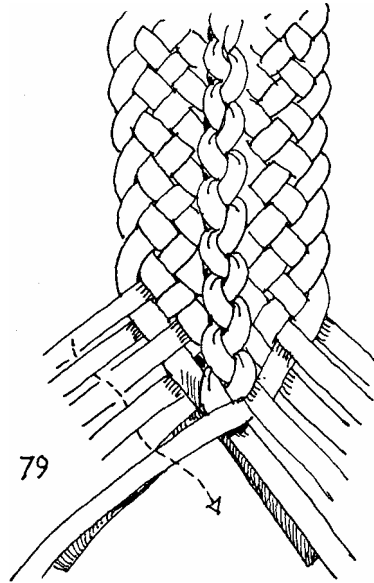
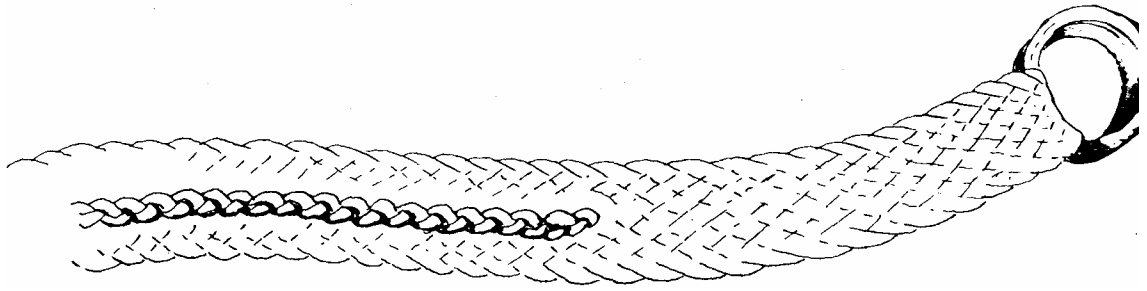

In this way the belt is brought back to its original number of strands and so plaiting goes on in the normal way.

After a few passes the lower strand of the doubled strands can be trimmed off.

The belt is now completed in the normal way.

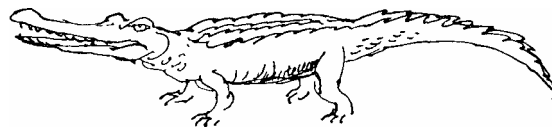

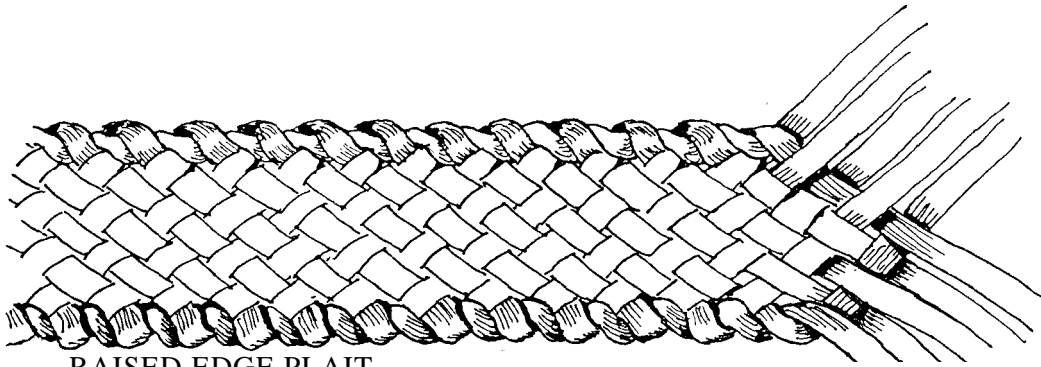

RAISED EDGE PLAIT

The raised edge plait is known to most good bush plaiters even though they may seldom use it. The method is simple, instead of beginning with the outside strand the second strand is picked up. This is bent as shown in fig.81 and neatly folded around the outside strand, thus forming a ridge.

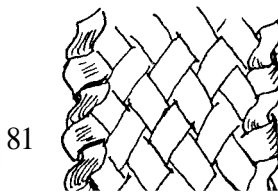

Although these various ridge patterns are simple enough they only look good when done by a skilled plaiter as the effect relies on uniform pressure and precise positioning.

Fig.82 gives an idea of the finished effect. The belt is started and finished as an ordinary flat plait.

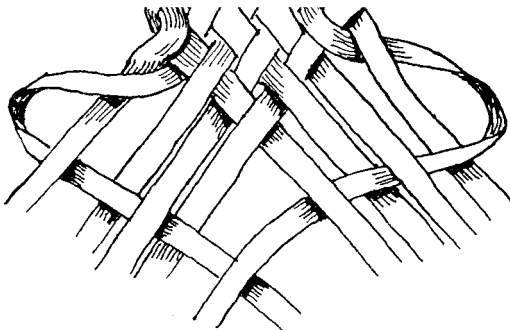

TRIPLE RIDGE PLAIT

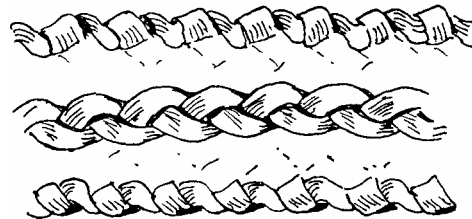

This only looks good when done on a 12 plait belt or over. It is easy enough to do once a certain amount of skill in plaiting has been achieved, though time consuming. It simply consists of a raised edge plait with a crocodile ridge down the centre.

Bush plaiters will usually begin with an ordinary flat plait **then** introduce the raised edge plait. They will do a few centimetres of this to get into the rhythm then introduce the crocodile ridge.

"COP THIS YOUNG HARRY"

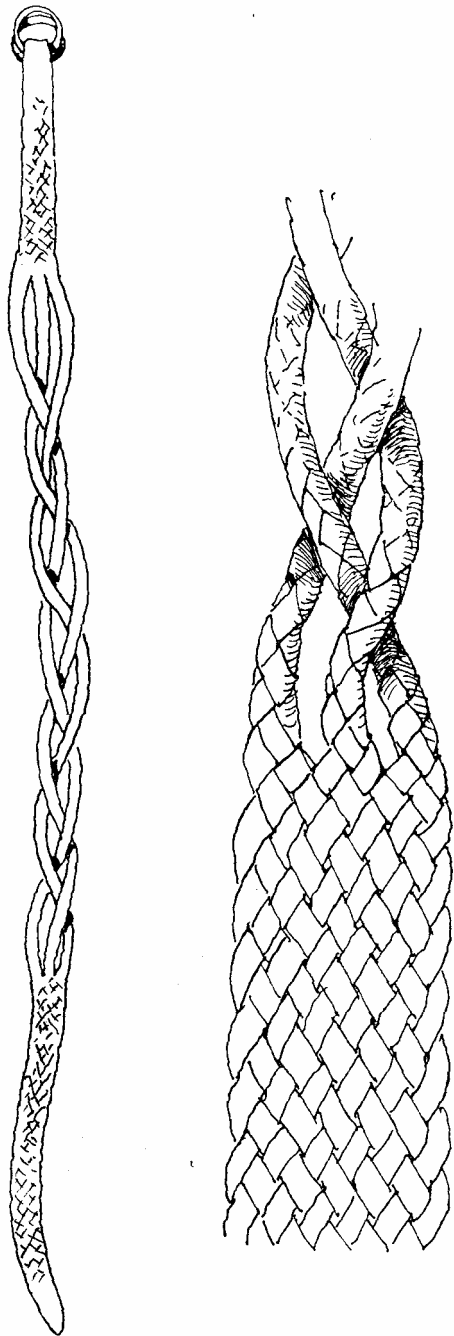

Nothing annoys a crusty old bushman more than the arrival of a young stockman who can plait as well as he can. When this happens the old expert usually asserts his position by creating the most complicated patterns and techniques that he can recall or invent.

Travelling around the outback I have often been shown examples of this sort of work, which is always beautifully done, though often not very practical.

An example of this is illustrated. This is a 12 plait belt which is then divided into three parts and these are then worked as separate 4 plaits for some distance before coming together again as a 12 plait.

These three straps are then worked together with the so-called 'secret' plait. The result is a belt which is not particularly attractive but which will set the rest of the camp scratching their heads.

As a matter of interest I plaited one up in order to do the sketch and found that it did not take much longer than an ordinary plaited belt. In another version of this belt the three centre straps are worked into round plaits, using lengths of cord or greenhide as a core. These three round sections

are then plaited together with the secret plait. This looks a little better than the previous one.

In yet another variation these three or more round sections are not plaited together but are left parallel and linked together with lace in one of a number of ways.

Interesting as all these variations are there is no doubt that the best looking belt of all is the simple twin ring belt, the real bushman's belt.

A variation of the previous idea can be used to create small openings in the belt from which can be hung key-rings, snap hooks and similar items.

In this case a 12 plait is divided into three sets of 4, and these are then plaited for a short distance before coming together again in the 12 plait.

Variations of this idea can be worked with any number of strands.

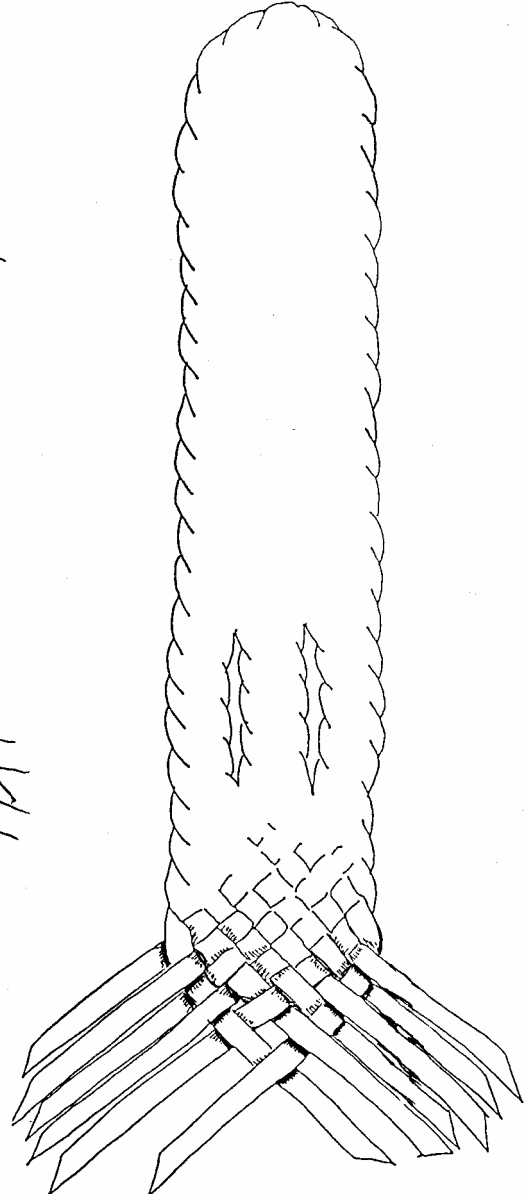
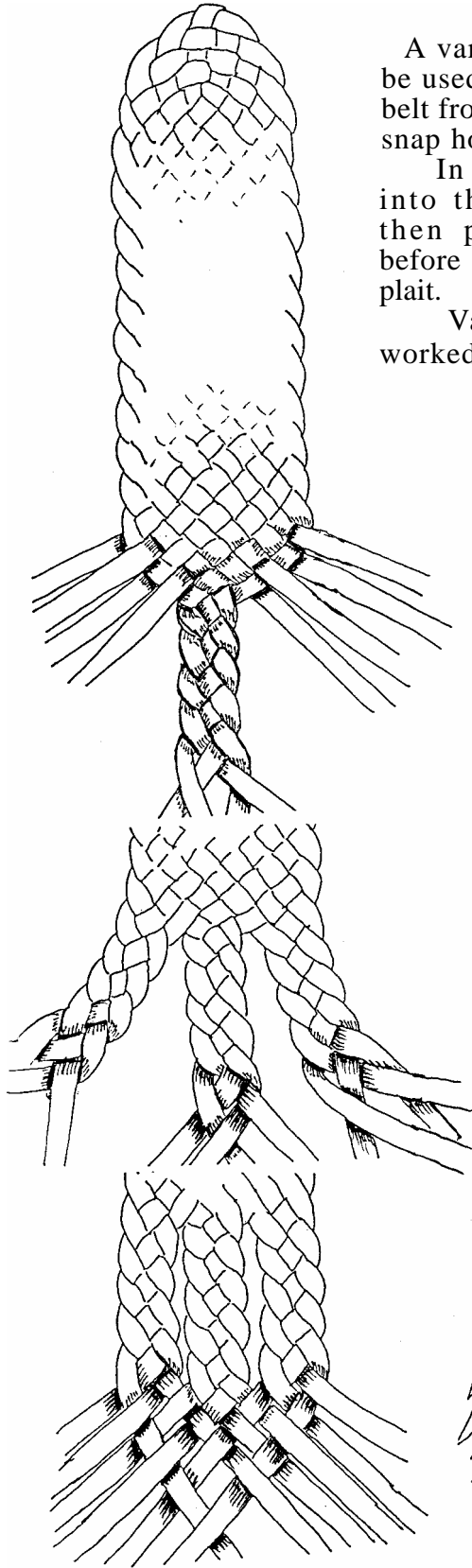

## HAT BANDS

Bushmen often plait hat bands in the same way as ordinary belts. However because of the relative narrowness of the band they usually do not bother to plait a keeper. Instead when trimming off the surplus lace they will leave a single strand and pass this around the strap to form a keeper as in fig. 88.



88

## WATCH BANDS

Plaited watch bands can be made quite quickly, and are extremely light and comfortable as well as being very strong. Just as a matter of interest I timed myself from measuring the lace to completing the strap ready to fit the buckle and found that a 6 plait of 4.5mm lace took only 9 minutes.

The simplest calculation for the length of lace in a watch-band is to make the strands double the circumference of your wrist.



36

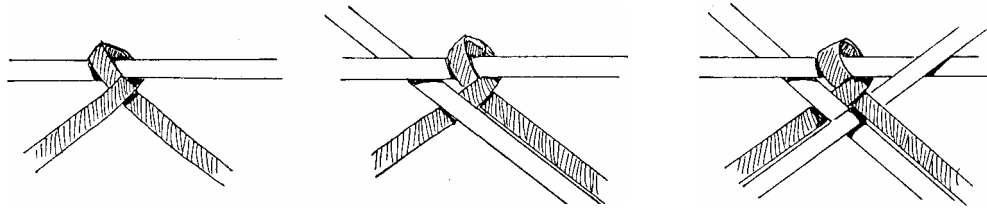

Plaiting expert Lindsay Whiteman of Townsville, Qld, showed me another method of starting a belt.

He prefers this method as it gives the same pattern in the point as in

the rest of the belt. In the common method of starting, shown earlier in this book, the strands in the point follow a curve.

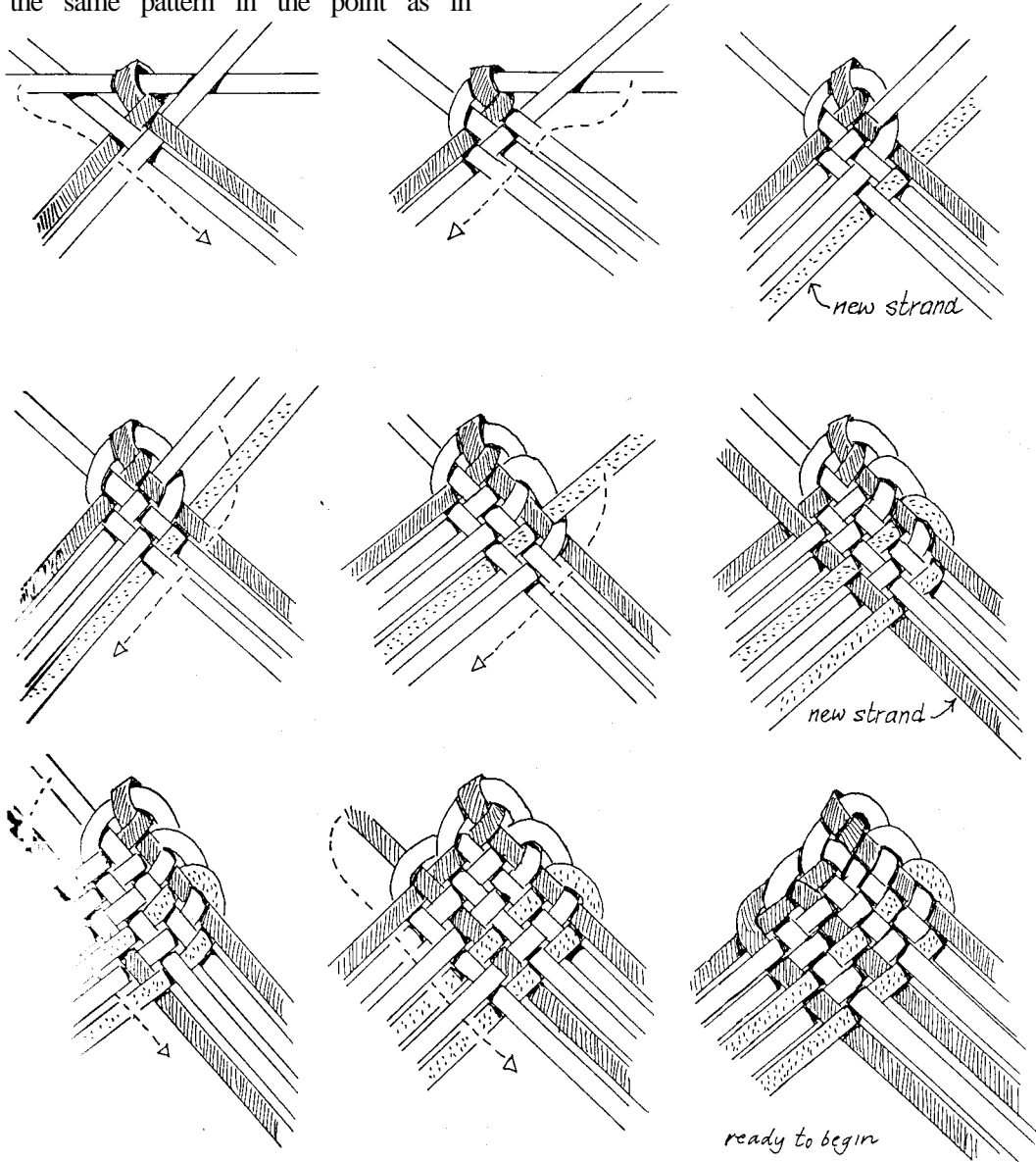

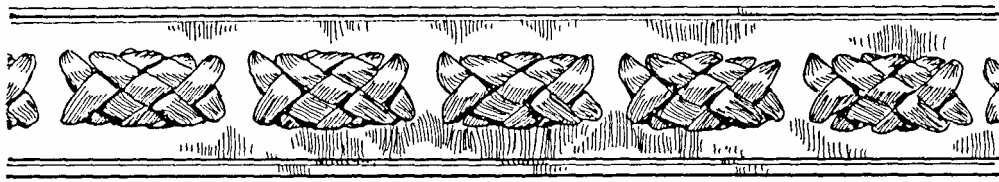

2

# BRAIDED BELTS

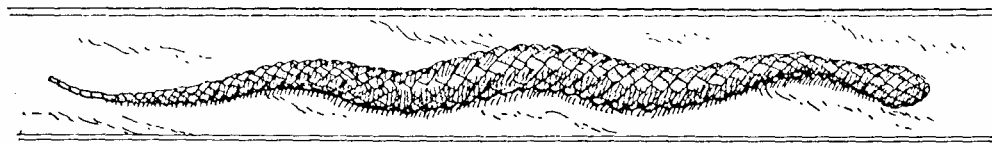
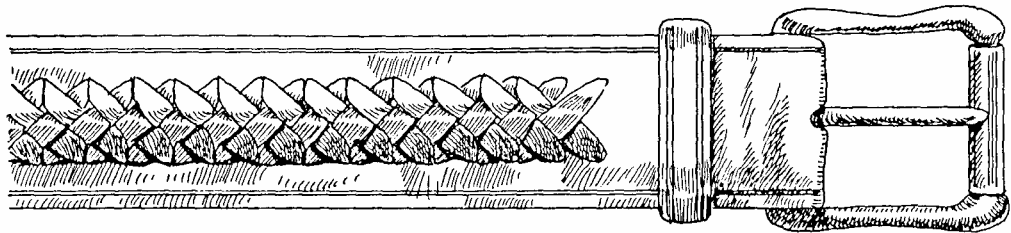
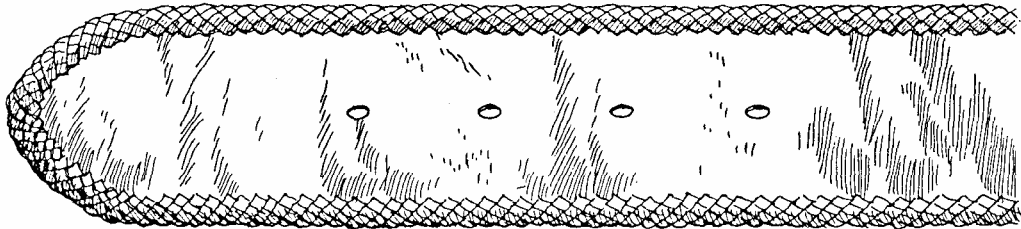
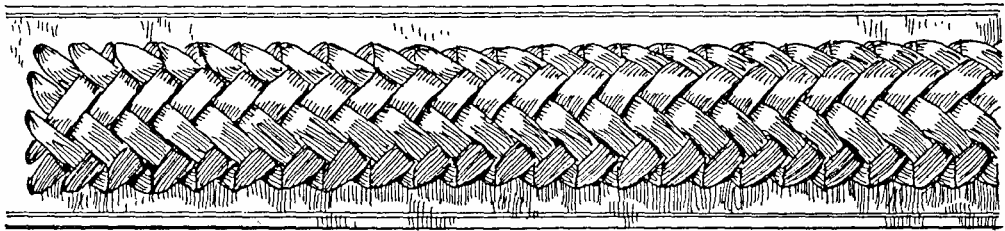
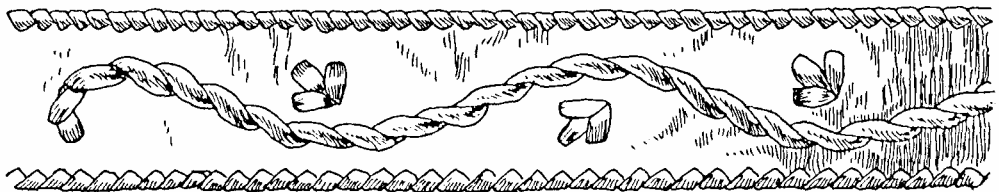

# Round edge braiding

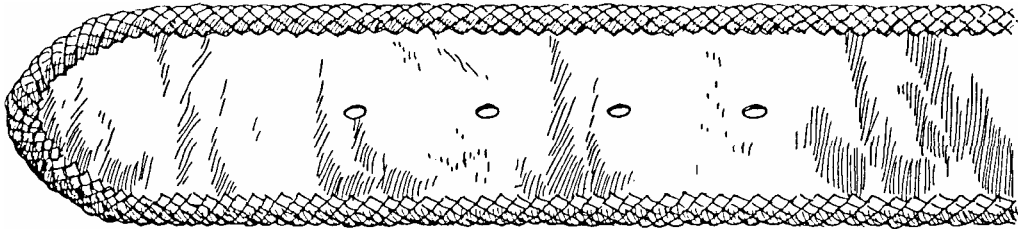

This is a very attractive addition to a plain belt. The method is easy to remember and simple to do.

The braiding is done in four operations, and only the last one is time consuming.

Before beginning punch a dozen holes in a scrap of leather and try out a small section. In this way you can find out the best distance to have the holes according to the lace that is being used.

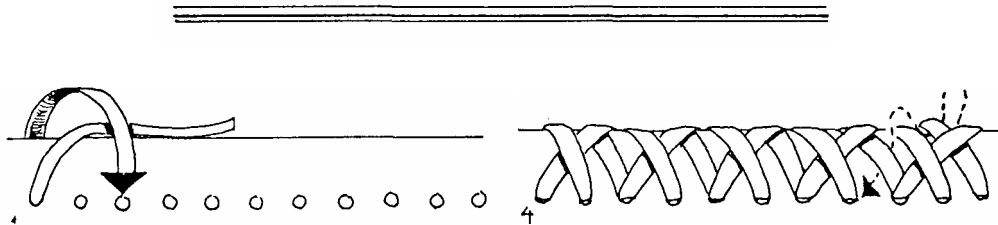

Fig.1. The end of the lace is put out of the way and soon is hidden by the braiding.

Begin at the buckle end of the belt and go through every second hole.

Go right around the belt and back to the buckle end on the opposite side.

Fig.4. The fourth pass is the slow one, and a lacing needle is needed, even a home-made one consisting of a bent piece of tie-wire is better than nothing.

The lace is taken in a sequence of under-over-under, and then into the holes that only have one strand of lace through them.

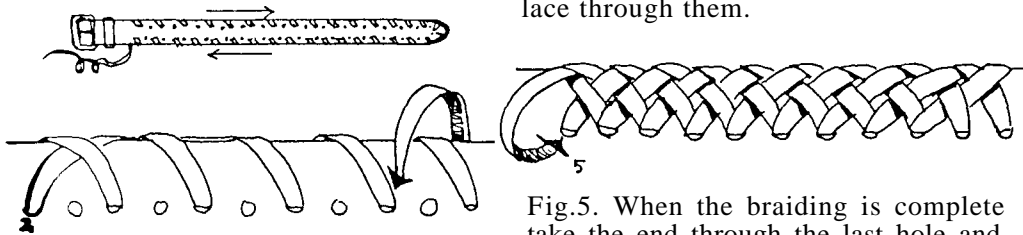

Fig.2. When the end is reached back again through the same holes.

Fig.5. When the braiding is complete take the end through the last hole and then use the needle to take it back under a few strands at the back of the of the job, and so lock it in place. In the drawings the lace has been shown thin in order to better illustrate the method. When actually doing the braid the lace should be wide enough so that the belt leather cannot be seen through the braiding, as shown in the sketch of the finished job.

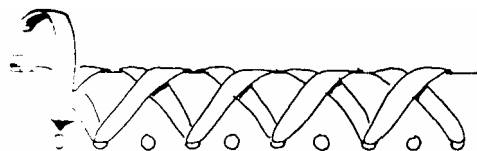
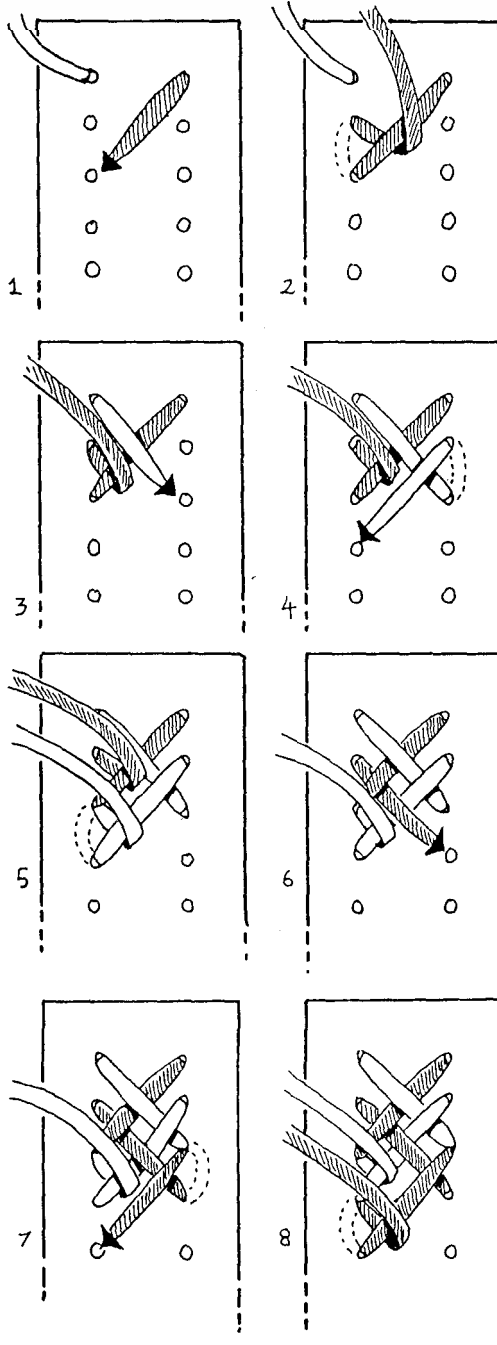
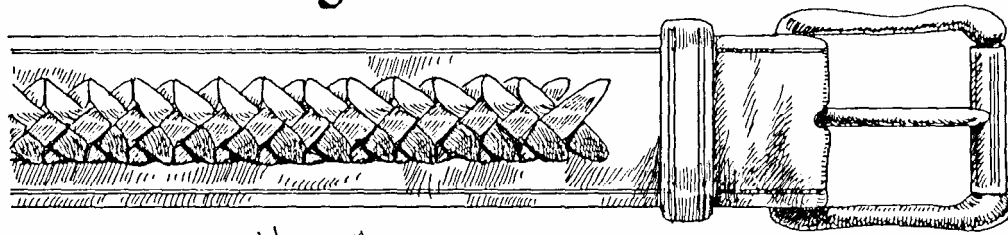

Fig.3 The third time around the lace is taken through the empty holes.



# Single strand centre braid



This attractive braid can be worked with a single strand of lace. In the drawings I have shown one half of the lace dark so as to make the working as clear as possible.

One great advantage of this braid is that it can be worked without a needle if desired.

Fig. 1. Bring half the lace out through the top left hole and half through the right.

Take the right hand strand across and into the third hole down.

Fig. 2. The strand is then taken up, and comes out through the second hole. It is pushed under the lace already in place and is then folded back out of the way.

Figs 3-5. The left hand strand goes across to the right, in, up, across to the left, in, up, under the strand on top and is then folded back out of the way.

Figs 6-8. The upper strand is now folded down and follows the same sequence.

When fig. 8 is reached the upper strand is ready to fold down and continue on.

Fig. 9. The braiding can be given a raised effect by glueing down a strip of skived leather to the belt.

Glue is not essential, as the braiding will hold the extra piece of

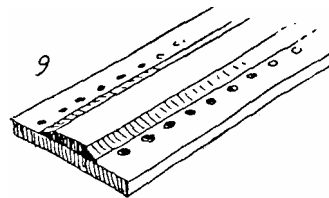

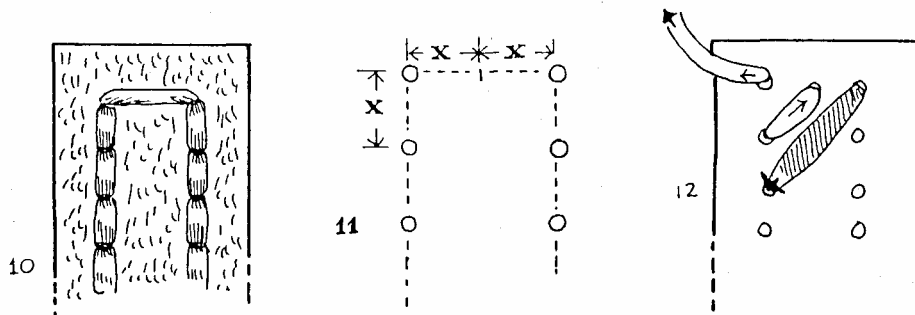

Fig. 10. When doing this braid I am always surprised at the way the front forms a complex braid, but the back of the belt only shows a pair of rows of neat stitches.

Fig. 11. In order to get a neat finish the holes are positioned like this. The

rows are positioned twice( $x4x$ ) the distance that the holes are apart.

Fig. 12. For an even neater start to this braid put an extra hole in the centre and begin as shown. The end is done in the same way

## Vine & flowers pattern

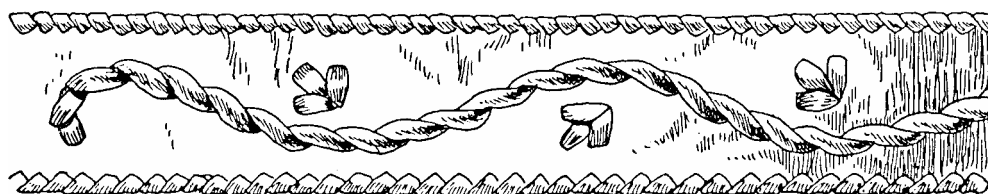

This is a simple pattern to work onto a belt. It looks very striking if

the leather is dark and the lacing is a light colour.

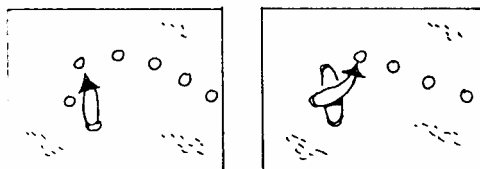
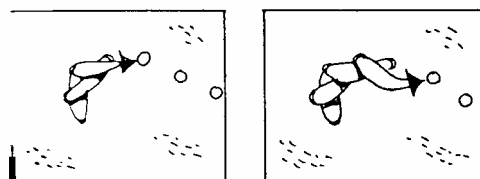
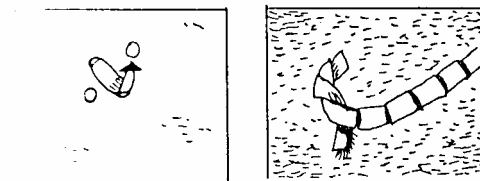

Fig. 1. Punch the holes as small as possible and choose a wide rather than a narrow lace.



The sequence is simple, go forward two holes and back one. Figs 2-4. Continue the sequence for the whole length of the belt - forward two holes and back one.



Remember to always bring the lace out above the previous stitch. Fig.5. The flowers can be worked as you go along. Always put in the centre stitch first.

Fig.6. This is the back of the job. When you begin stitching you trap the loose end under a couple of stitches.

When the lacing is completed the end is also threaded through the stitches in the same way.

Like all braiding a needle makes the job much easier. If a proper lacing needle is not available a hairpin or piece of tie-wire can be used as a needle.

# Twelve point braid

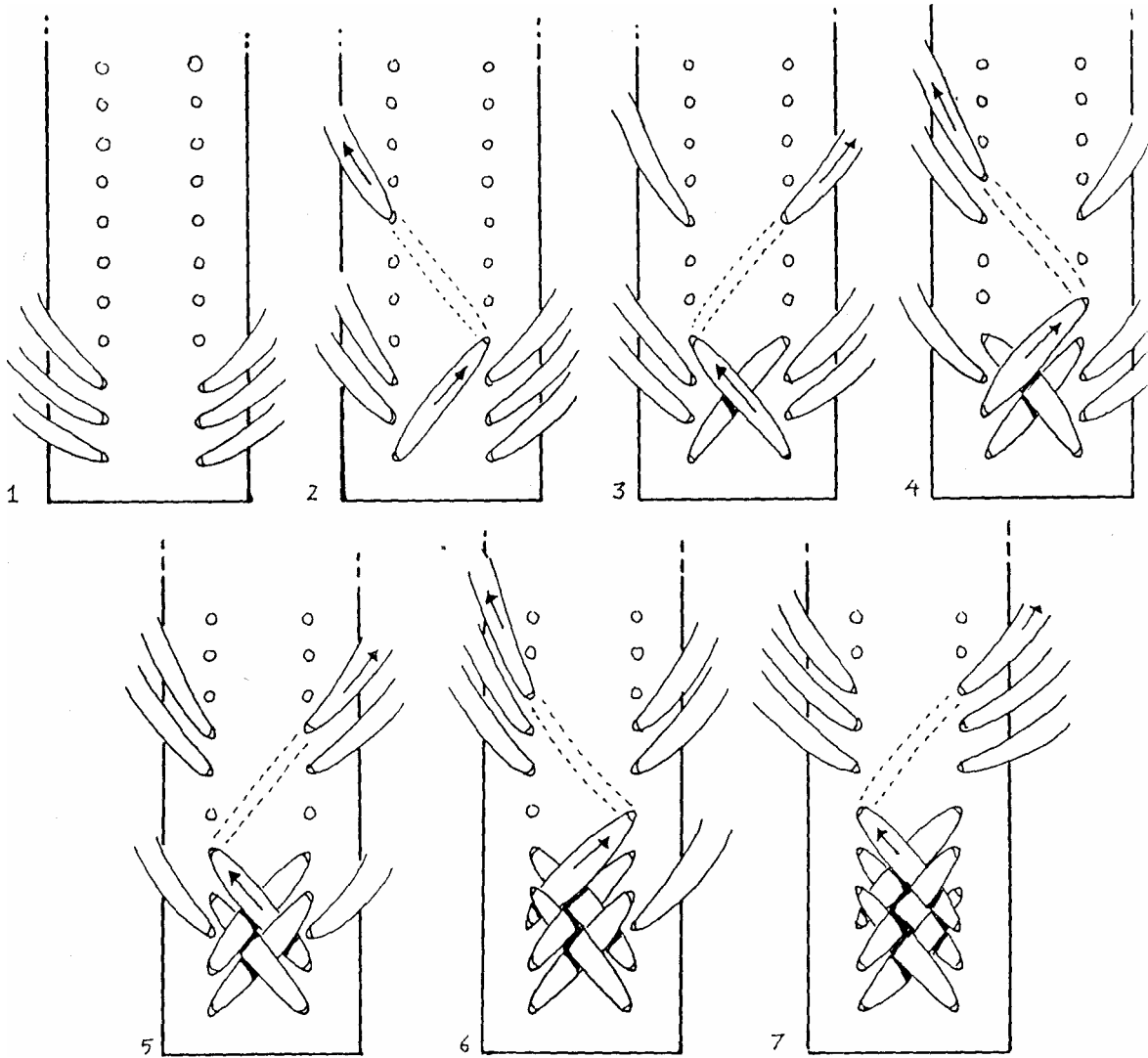
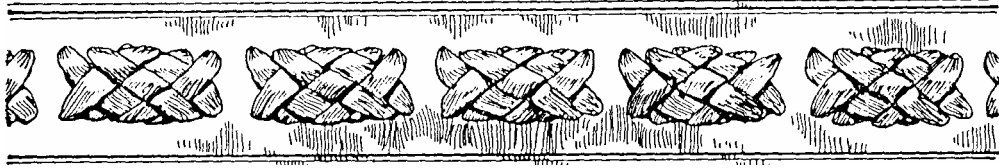

This unusual braid features a series of small braided sections, each of twelve points.

Fig. 1. Take three long lengths of lace and put them in the bottom holes to form six strands. Figs 2-4. For the first three moves each strand is simply laid on top of

the previous one.

Figs 5-6. The strands must be placed under the previous strands as shown.

Fig. 7. The first braided section is now complete, and the six strands are ready to begin forming the next section.

# Wide braiding

This wide braid is very attractive, and also has the advantage that it can be worked without a needle.

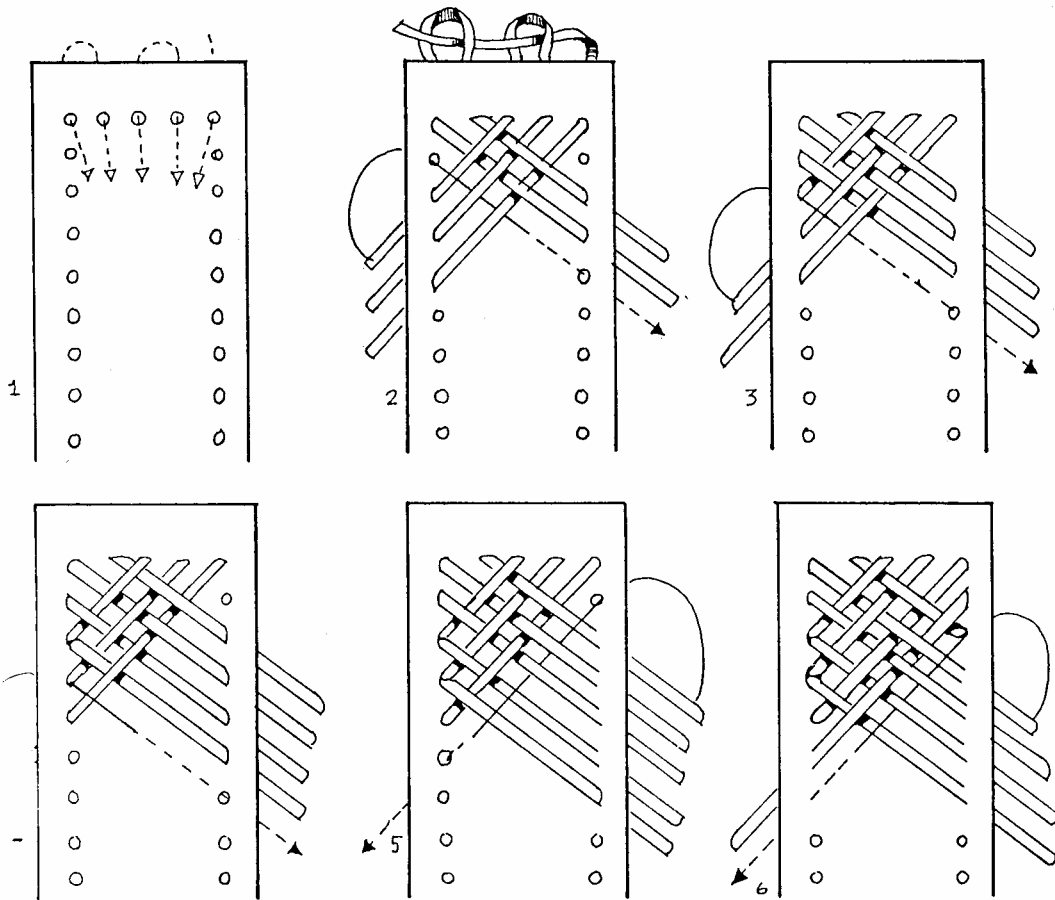
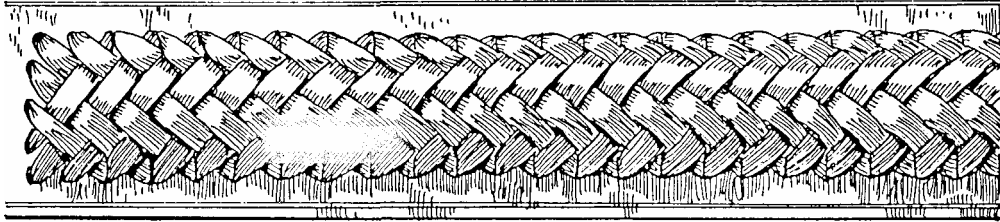
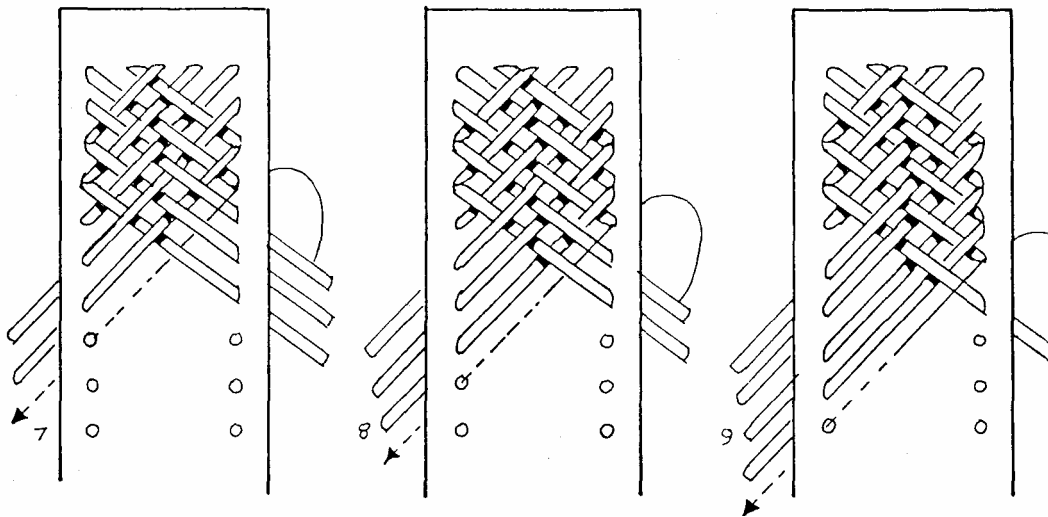

Fig.1. Five strands are used, but it is simpler to use three and put them in as shown in the dotted lines. Fig. 2. Arrange the strands as shown, make the upper left strand up and through the hole above it, then over one, under two.

Figs 3-5. The other strands are also taken up and through the hole above, then over and under until all five strands are on the one side.

Fig. 6 The strands are now all worked back to the left side.



Figs 6-10. The same sequence continues. Each strand is taken up through the hole above and then goes over one-under two-over two.

When all the strands are on the left side they are worked once again to the right, and so on.

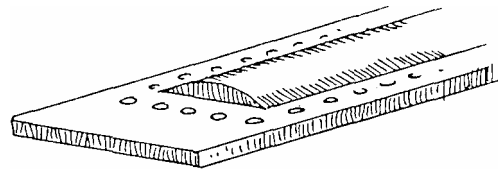
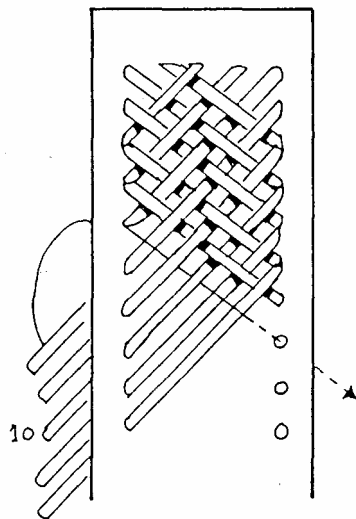

This braid looks very attractive if a shaped piece of leather is placed underneath it, giving a rounded effect to the belt.

To make the sketch easier to understand the lace has been drawn very thin, but when working it use a lace wide enough to touch the strand next to it, so that the finished braid will look like that at the beginning of this section.

## Covered Buckles

A leather covered buckle sets off a well braided belt. Although the method may look a little complicated it is quite simple once you have begun.

The amount of lace needed will vary with each buckle, but it will usually be around ten times the distance round the buckle.

the very first strand that began the

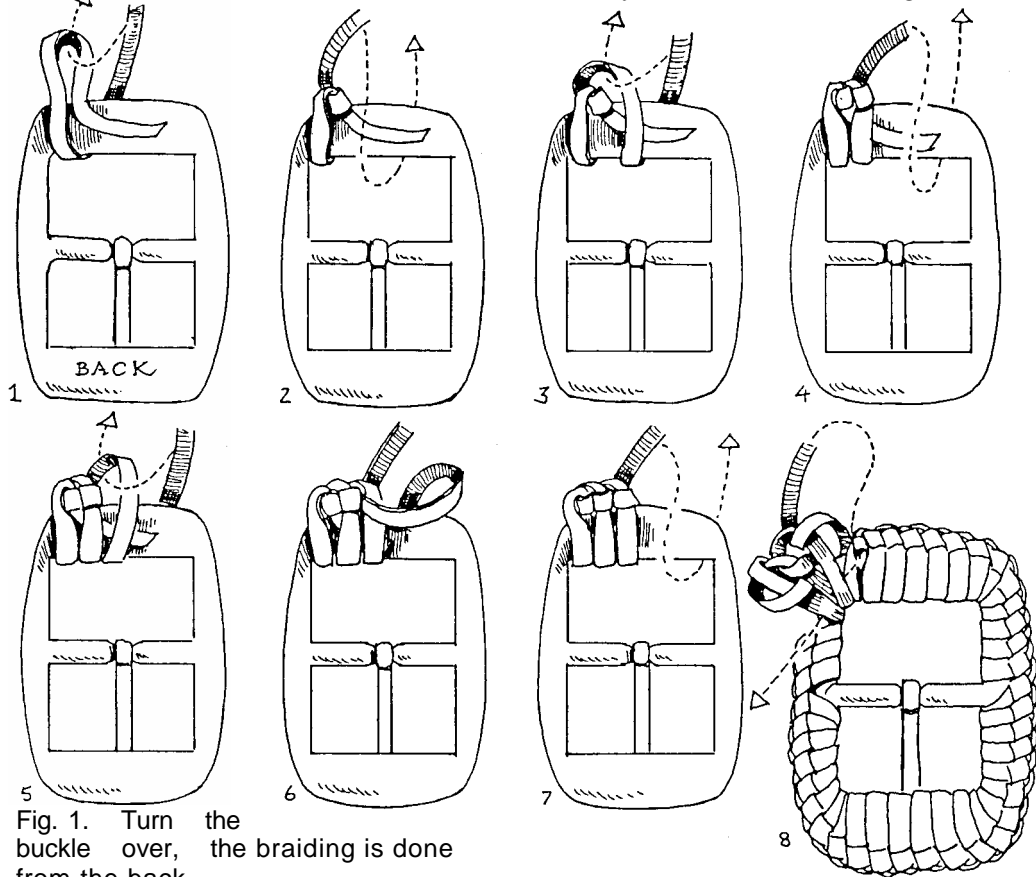

Fig. 1. Turn the buckle over, the braiding is done from the back.

Bend the lace as shown, then bring the end through the loop as shown by the dotted line.

Figs 2-5. As the braiding continues the end is hidden from view and locked in place.

Fig. 6. There is a technique to getting a good firm job with a regular edge.

The loop is held open as in fig.5 and the end passed through it. The loop is then pulled tight as in fig.6.

Fig. 7. The end is then also pulled tight and the knot is complete.

A needle is not needed when doing this covering.

figs 8-9. When finishing up leave the last two or three stitches quite loose.

Pass the end of the lace through

job, and feed it under the loose stitches.

Pull the loose stitches tight then pull the end firm and cut it off flush.

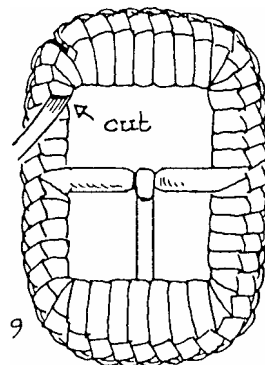
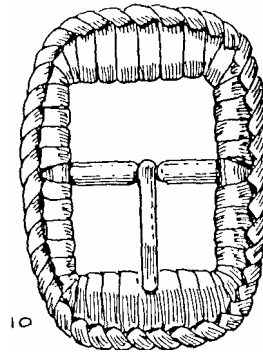
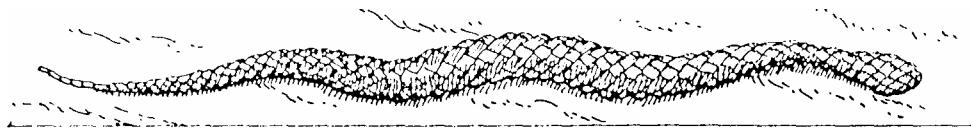

Fig. 10. This shows the finished buckle from the front.



## A Braided Snake



All sorts of designs can be braided onto belts, and this is a typical sample.

The snake can be made to any length and width as desired, the one illustrated here was 350mm long and worked onto a belt 38mm wide.

A single strand of lace 3500mm long was used.

Fig. 1. Begin by putting the ends of the lace through two holes in the head as shown, then continue as

shown in the other drawings.

The dotted lines show where the lace goes when underneath the belt. Fig. 10. Continue braiding in the same sequence. This braid follows the same pattern as shown for a single strand centre braid, also illustrated in this booklet.

Figs 11-13. The very end of the tail is formed with only a single row of holes, and is worked with only a single strand of lace.

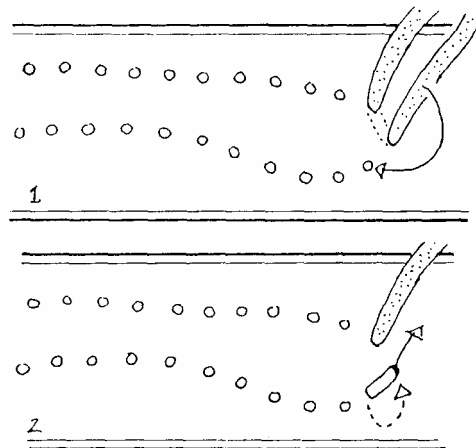

Follow the sequences shown here, when the tail is complete the end is tucked firmly under a few stitches at the back of the belt. The remaining length of lace is also tucked away under a few stitches.



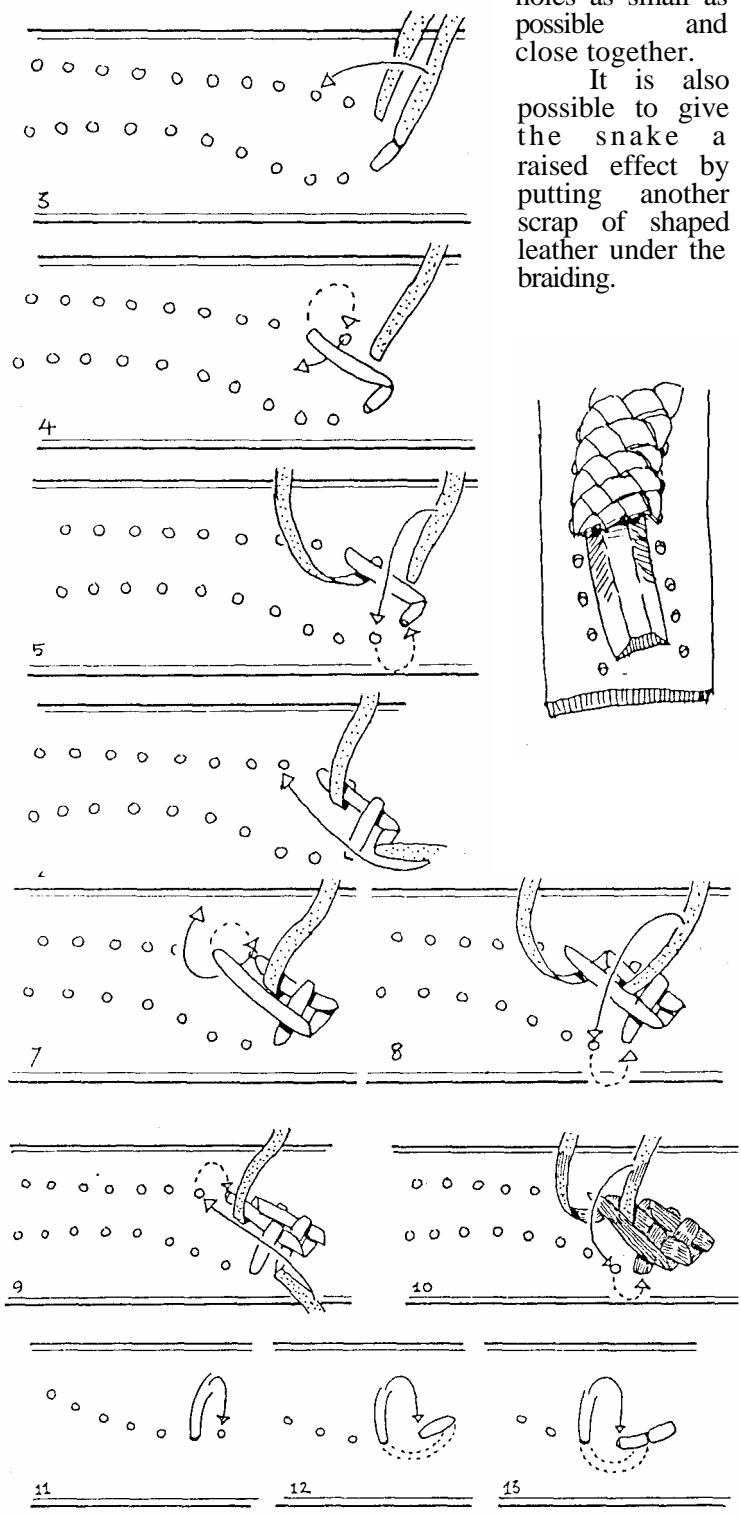
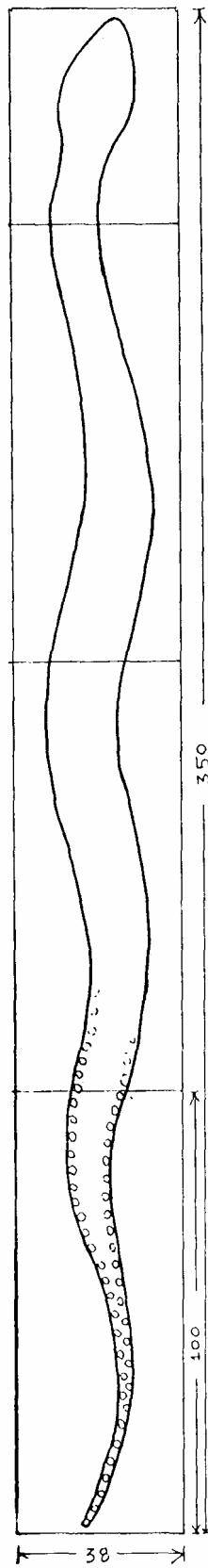

For the best effect make the holes as small as possible and close together.  
 It is also possible to give the snake a raised effect by putting another scrap of shaped leather under the braiding.

3

# THE SECRET PLAIT

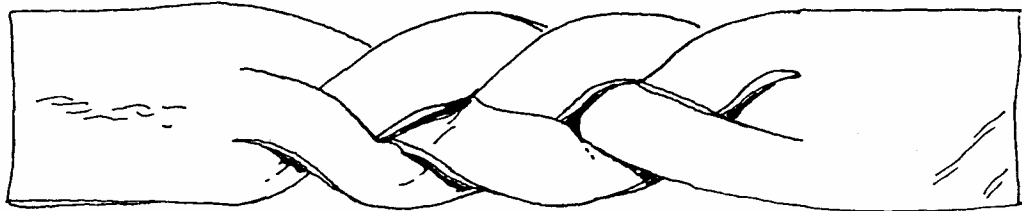

THREE PLAITS

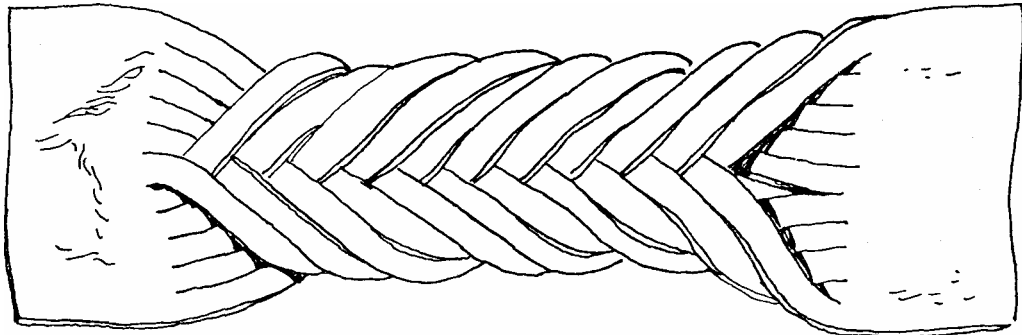

ELEVEN PLAITS

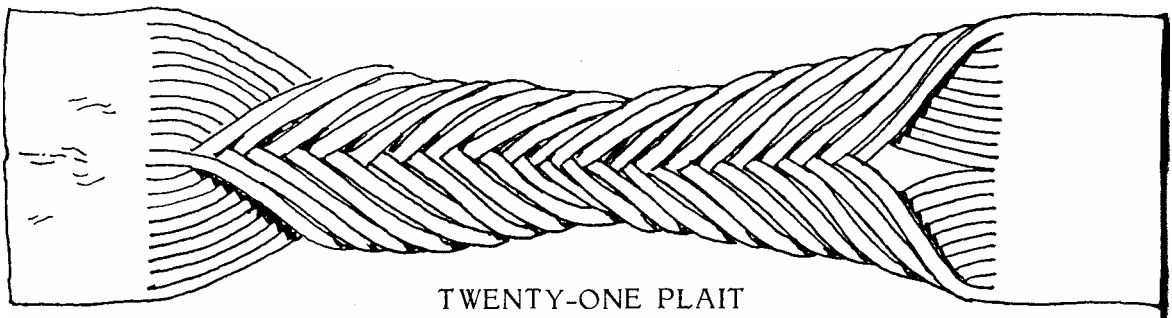

TWENTY-ONE PLAITS

This sketch shows what must be the most useless as well as the most complicated version of the secret plait to have been executed to date. I worked this one out on January 25 1983, and it is a 21 plait. Unfortunately I cannot see any possible use for it.

# The Secret Plait

To *the* layman the secret plait is an impossibility. There seems to be no logical method by which a belt can be plaited in the centre without either end being cut. I have heard customers in our saddlery shop become quite heated on the subject, and insist that such belts must have been cunningly glued together after the plaiting has been completed.

Leatherworkers know differently, yet many otherwise skilled craftspeople still approach the task in a rather hit and miss manner, simply pushing strands about until they hit the correct combination.

In this chapter I have laid out the method for producing three, five, seven, nine, eleven and thirteen plaits. I worked this method out some years ago, and since then have looked in every available book on leatherwork, but have yet to find any other writer describe it, and yet I find it to be the easiest method of all.

## ALLOWING FOR SHRINKAGE

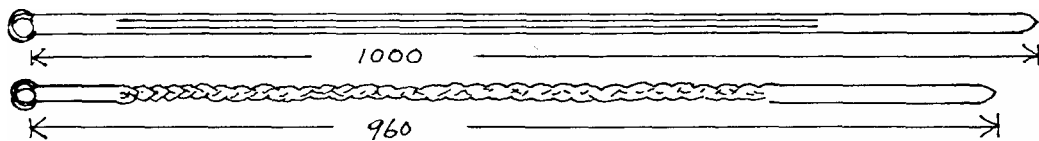

When a belt is plaited a certain amount of length is lost, but not nearly as much as many writers claim. As an experiment I prepared a belt exactly one metre long x 25mm wide and worked it into a three plait. The loss was only 40mm, or 4%. The leather was 2.5mm thick.

As a check on this I then chose a 3mm leather and plaited a five strand, beginning one metre long and 30mm wide. Again the loss was only 40mm.

As a matter of interest a 25 plait shortened by 9%.

## THREE PLAITS

The following three pages show the full sequence for working the three plait. This is the simplest of all secret plaits and so is the one most often used.

It is best to practise this one before attempting the five or seven plait.

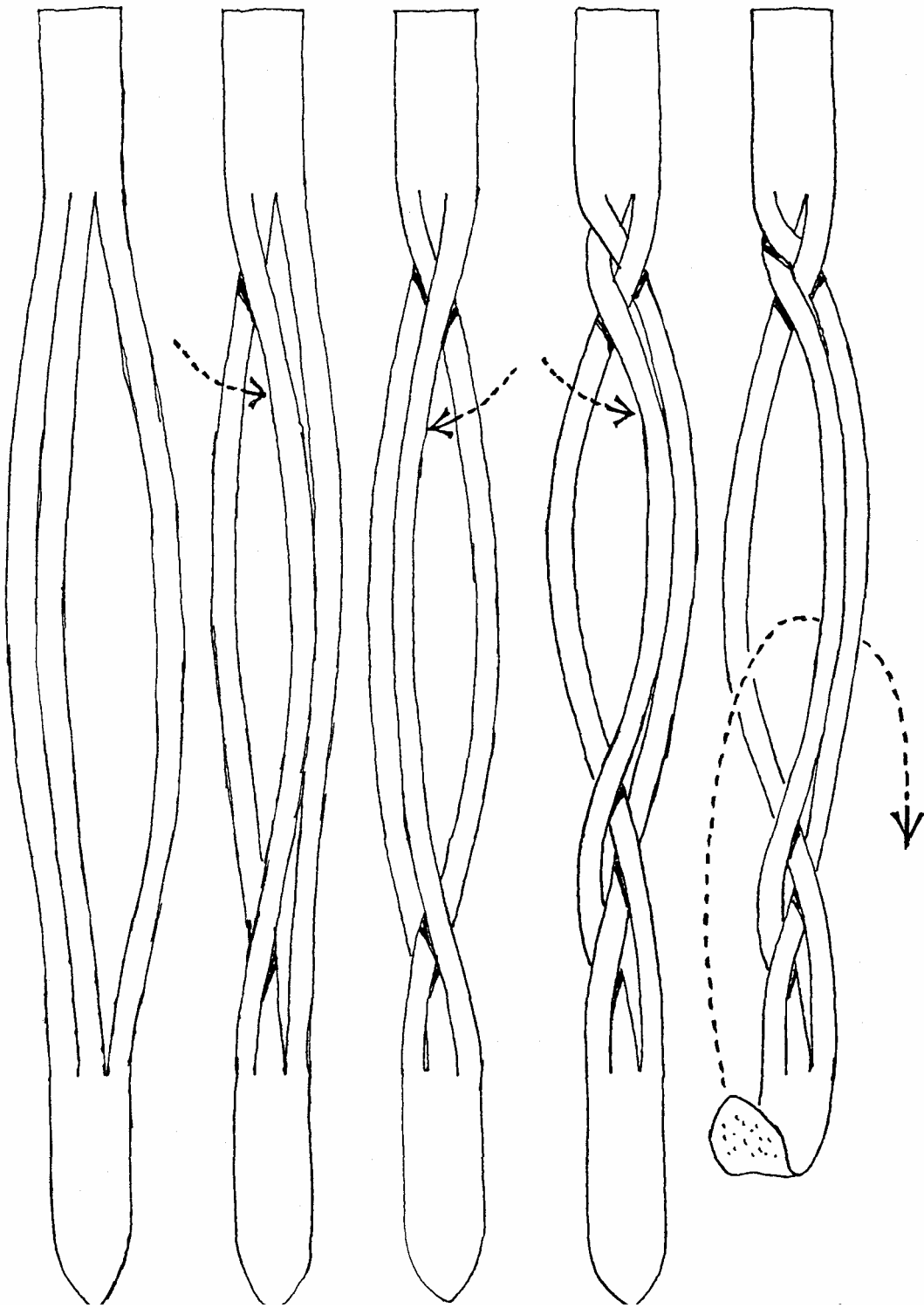

In order to avoid trouble it is important to count out each sequence as you go. The sequence for the three plait is one,  
50

THREE PLAITS

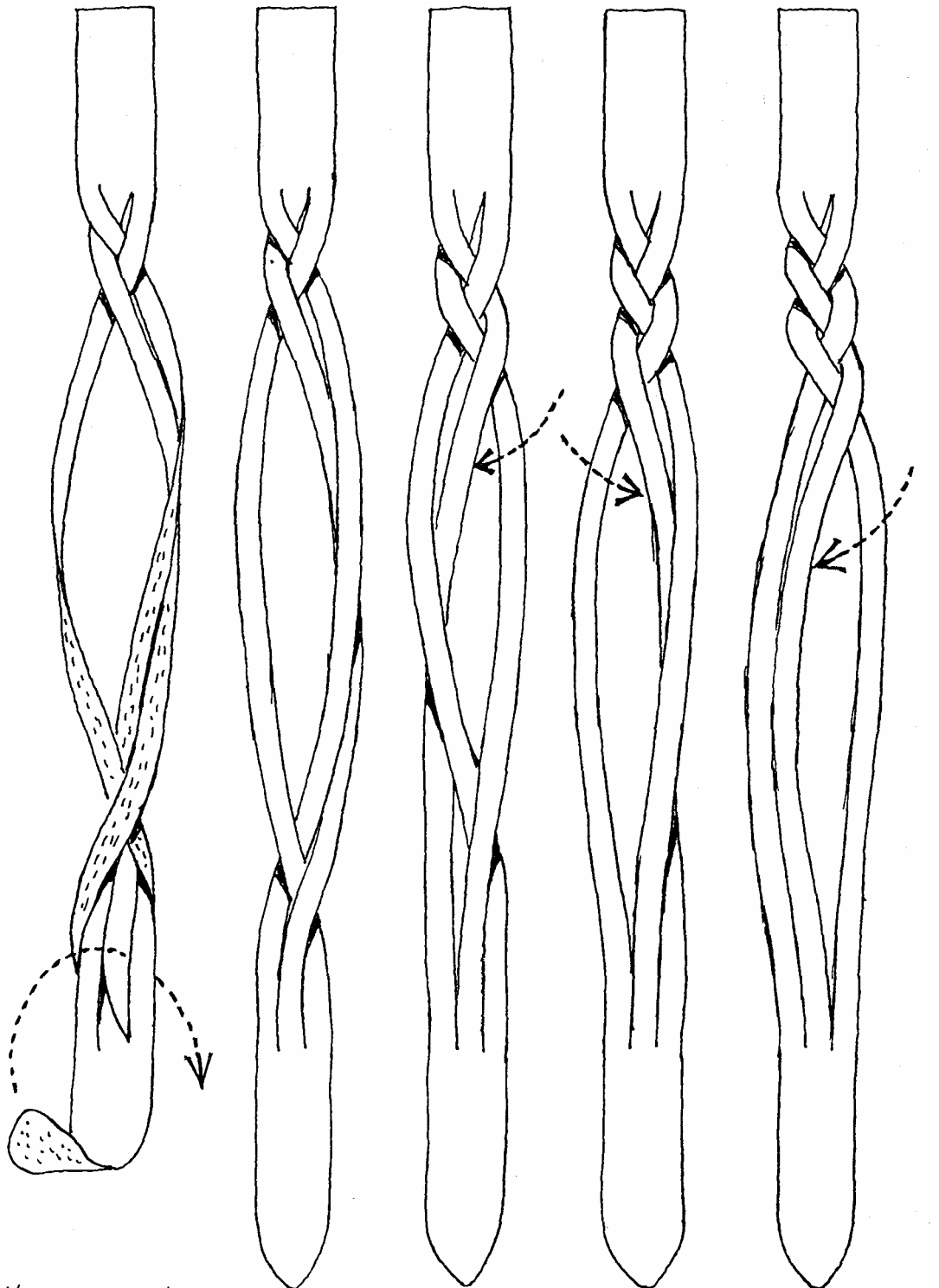

*through the bottom*

*4*

*5*

*6. end of sequence*

two, three, through the top, through the bottom, four, five, six. The sequence is now complete.

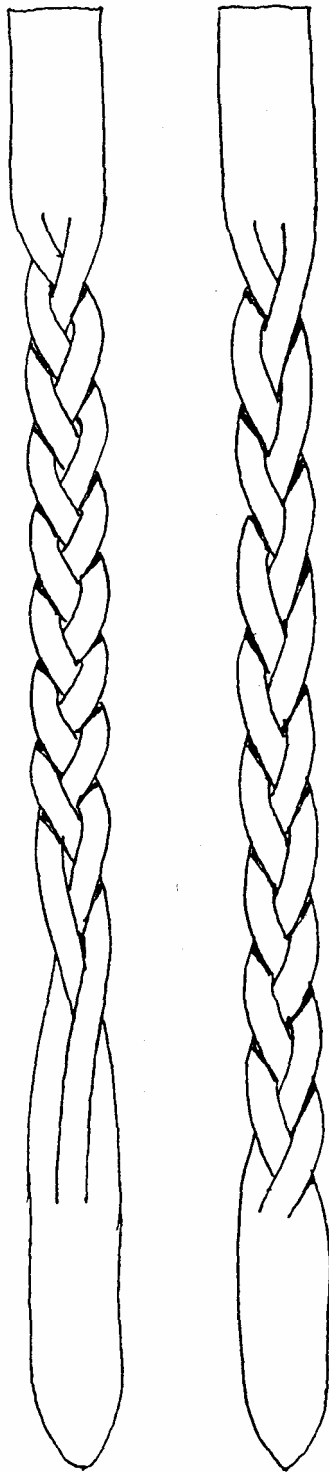

**THREE PLAITS**

On a very short length of leather, such as that shown on page 48(top), the plait is now completed, but in most cases you will be working a belt length and so the sequence is repeated until there is no more room to do another sequence.

When this happens the job will look like the left hand sketch. The work is then evened out until it looks like the right hand sketch. The plait is now complete.

*The secret plait is often used on reins to provide a better grip.*

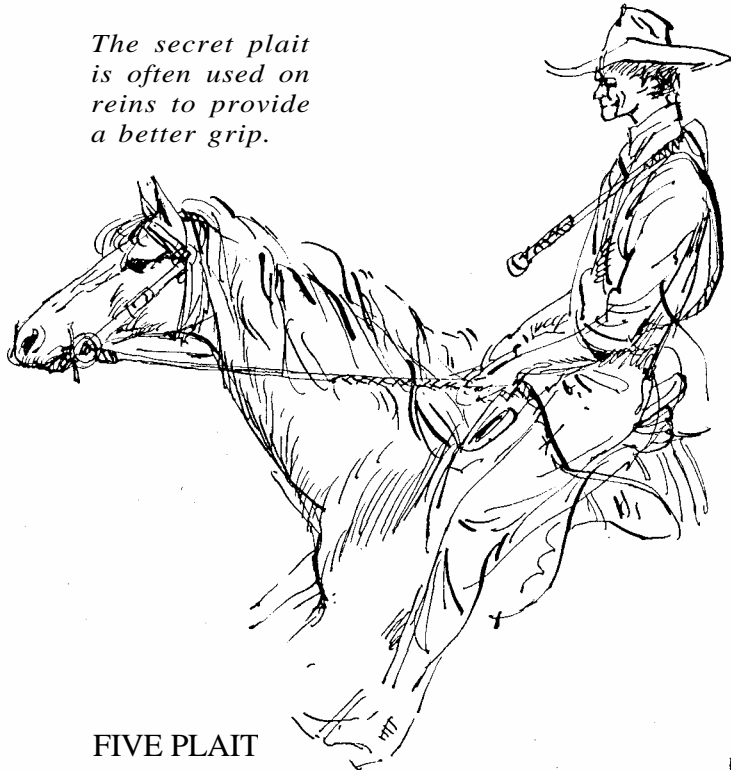

**FIVE PLAITS**

The five plait is the most attractive of all, and is just as easy to work as the three plait. In this case you count out the sequence as 1, 2, 3, 4, 5, through the top, through the bottom, 6, 7, 8, 9, 10. This is the complete sequence.



# Five Plait

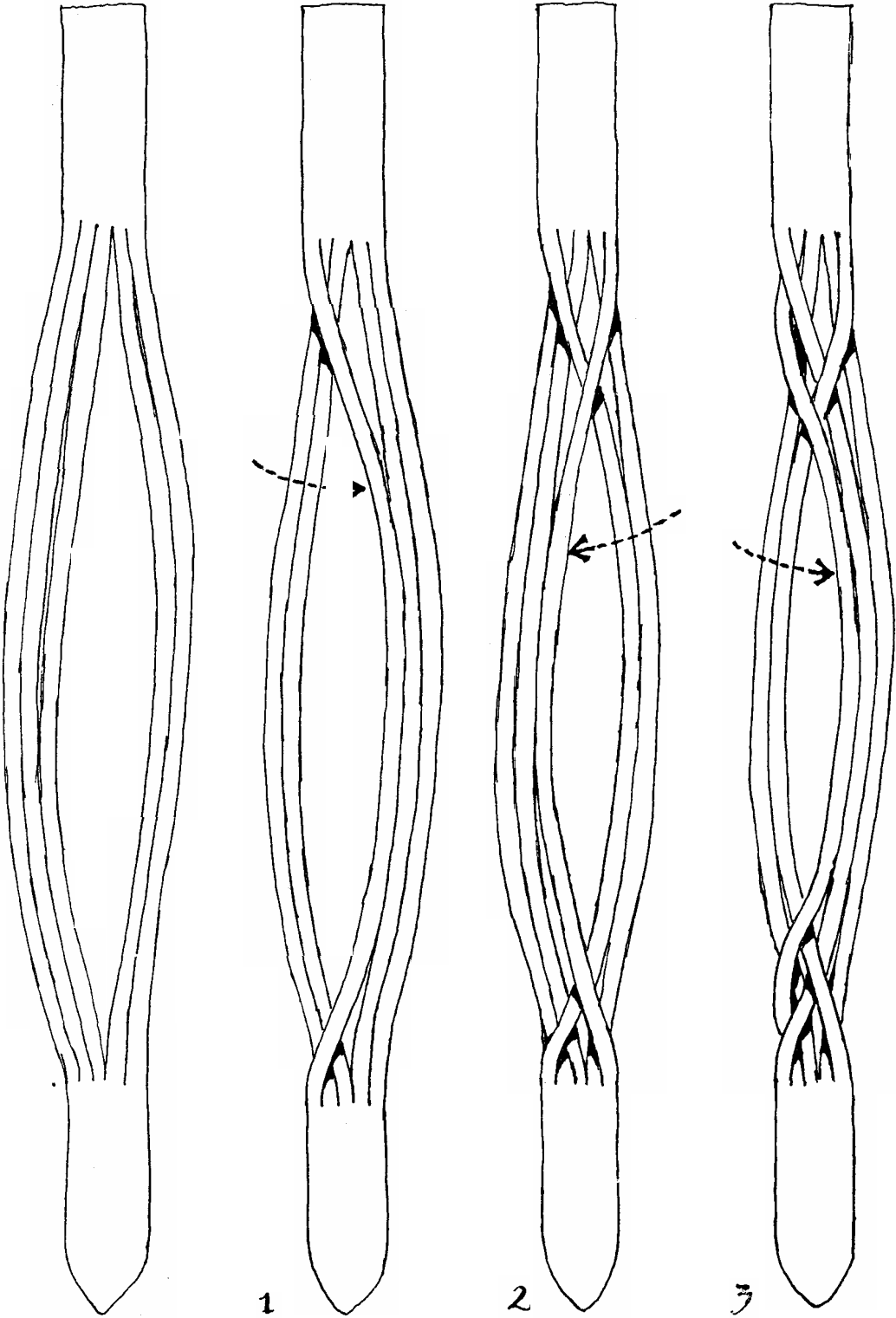

FIVE PLAIT

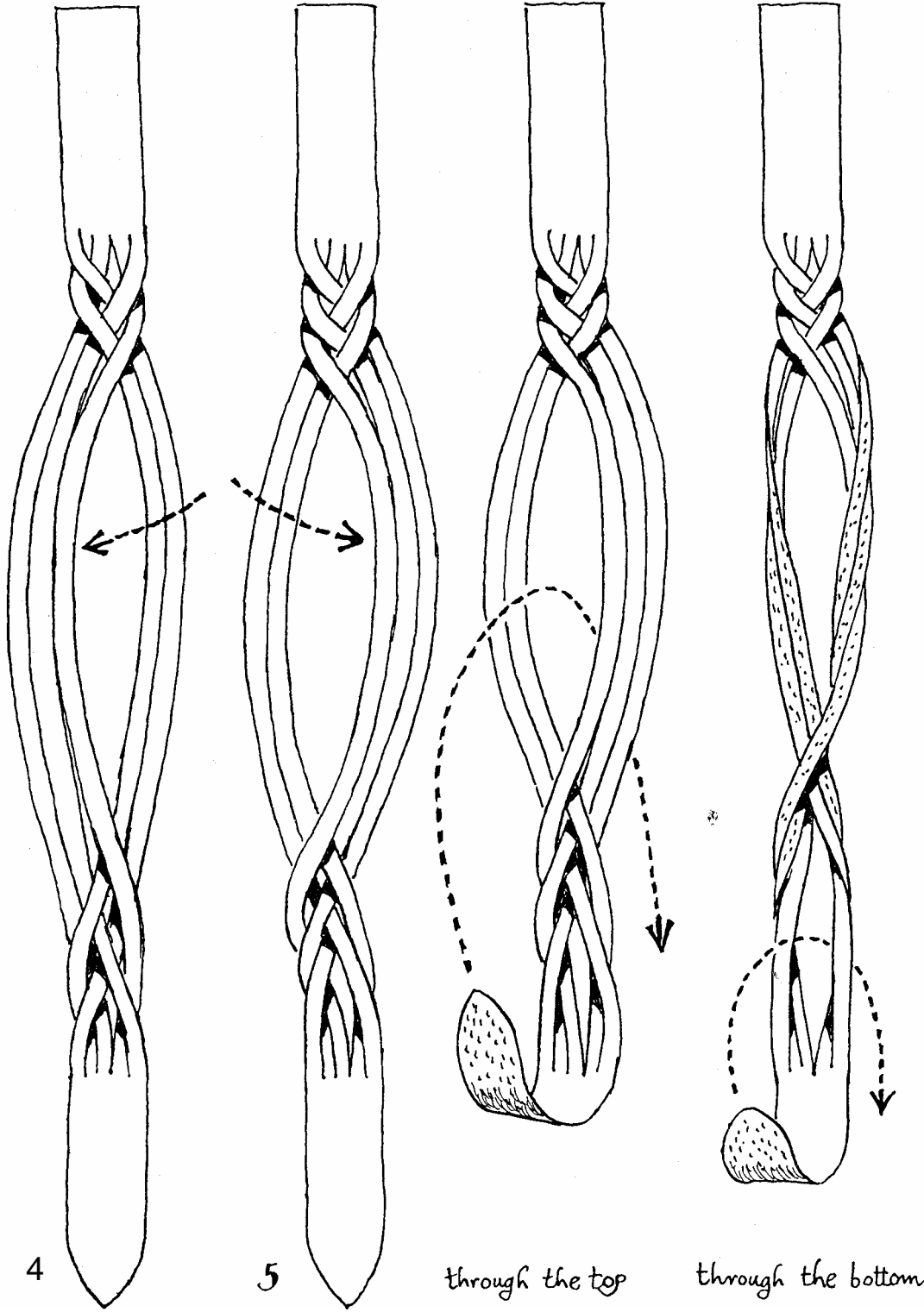



FIVE PLAITS

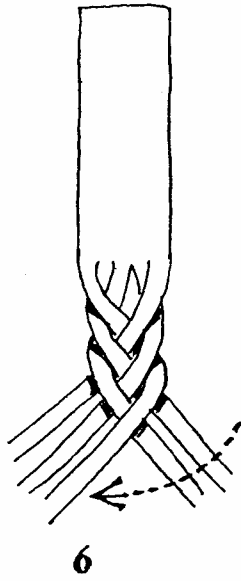

6

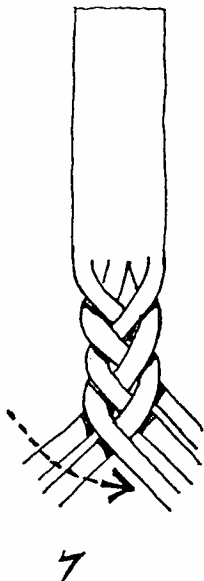

7

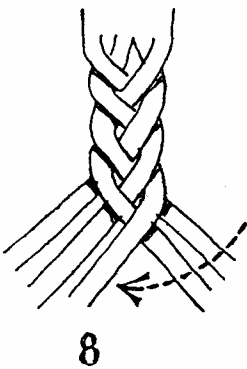

8

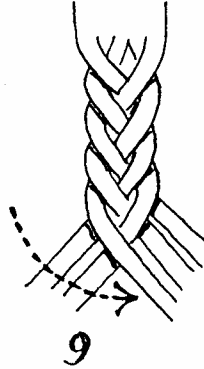

9

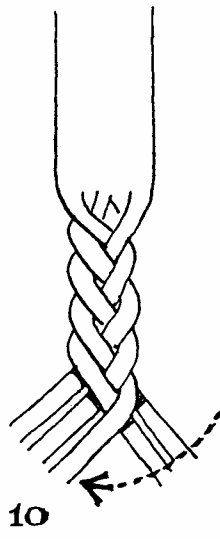

10

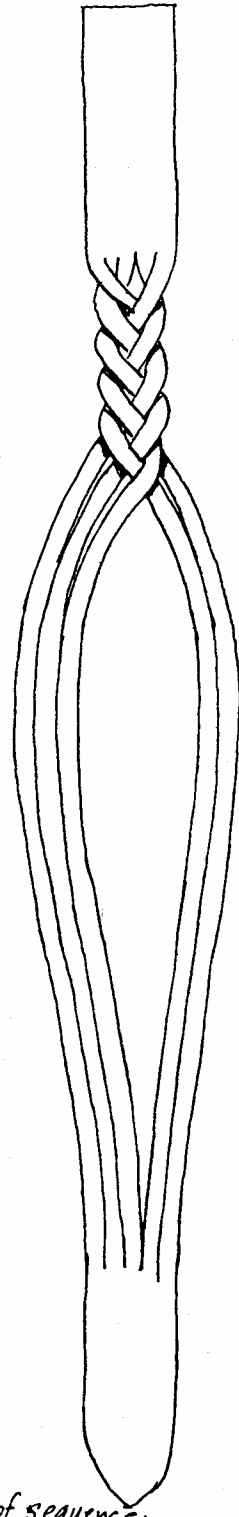

*end of sequence*

## FIVE PLAIT

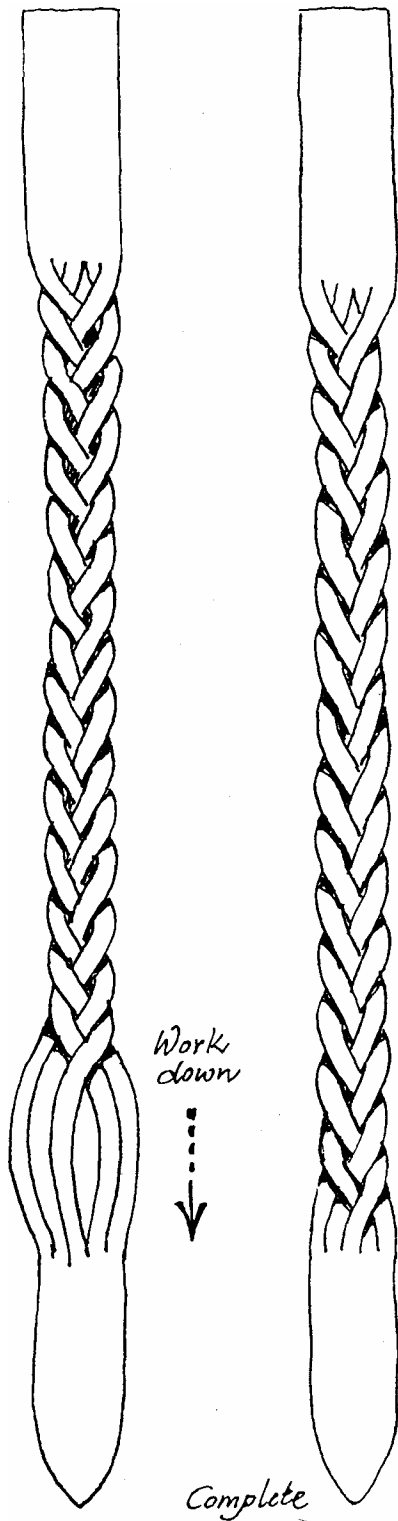

Repeat the sequence until there is no more room to do another one. The belt will then look like the left sketch.

Now work the plait down until it looks like the right hand sketch.

Everyone works out their own method of working the plaiting down, some simply tug at the strands to spread the plait while others turn the job upside down and work the strands out to an even spacing .



*A dog collar using the 5 plait*

## A DOG COLLAR

This attractive collar is easy to make using the secret plait. In leatherwork there are many techniques that look simple but are really difficult, this is just the opposite, the collar looks far more difficult than it really is.

It is best suited to large dogs. Plaited collars can also be a problem with long haired dogs because their hair gets caught in the plaited work. This collar

avoids the problem as there is only smooth leather against the dog.

I used such a collar on my wolfhound for a few years and had no problems at all with his hair getting caught.

The collar is made in two parts. The first part is an ordinary collar, this is cut in the middle into 3 or 5 strands and a secret plait is worked into it.



A wider piece of leather is then cut, and three slots put in at either end. If you do not have a slot punch the technique is to punch a hole on either side of the strap and then join them with two knife cuts.

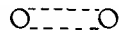

The plaited strap is put through these holes and the collar is complete, I have found that the two pieces do not have to be fastened together in any way, the plaiting seems to keep the wider strap from moving.

#### A COLLAR FOR A SMALL DOG

The secret plait can be used to make an attractive collar for small smooth-haired dogs. The five plait looks very fine, but the three plait is the easiest to do.

The making of a 3 plait collar is shown on the next page. Before beginning to plait cut the strands, round off the edges and then give the strands a good rub with oil or leather dressing. This will help stop the leather drying out and greatly increase the life of the collar.

It is best to oil and also polish the strands before the plaiting is done, as it is difficult to get a good penetration if it is left to the last.

The sketch shows the collar on my whippet.

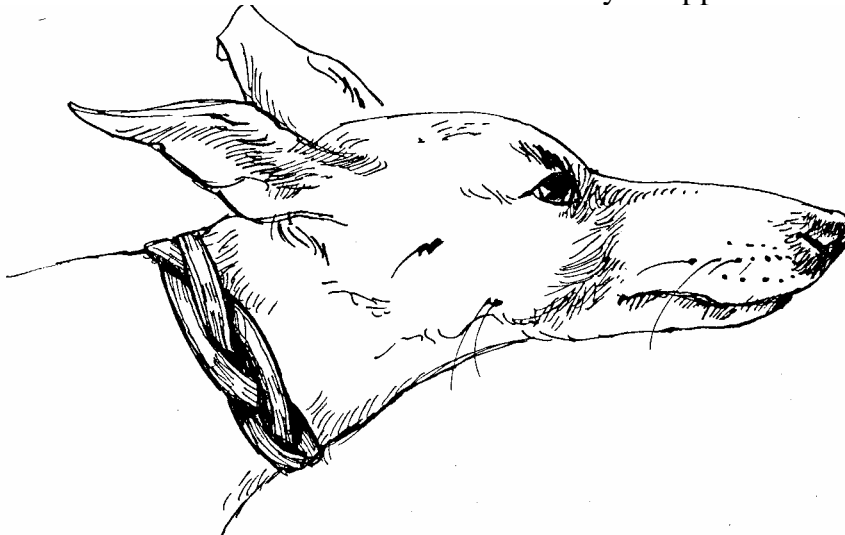

ANOTHER WAY TO DO THE THREE PLAIT

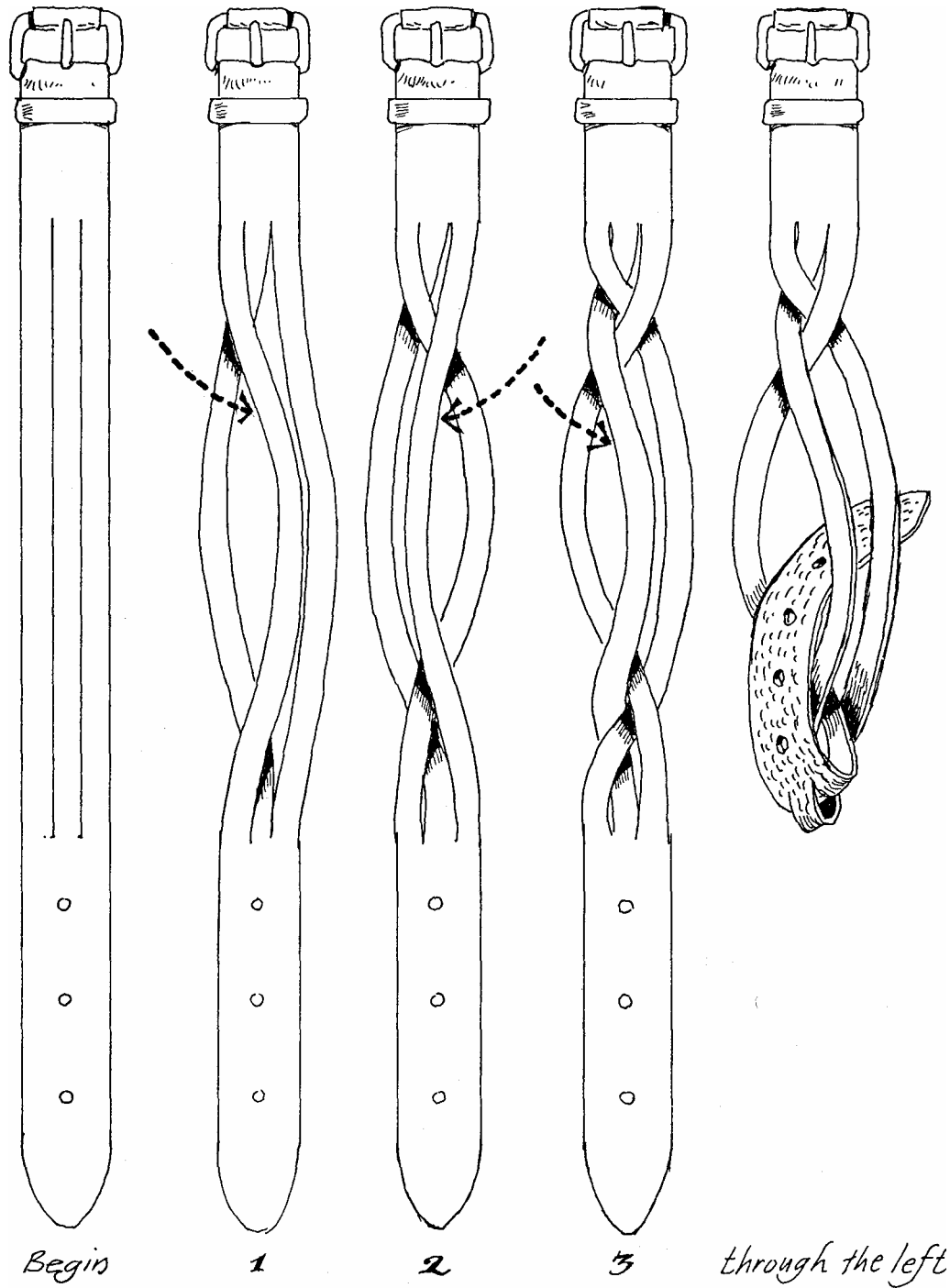

I know of at least three different ways to do the three plait, but I would recommend the beginner to stick with the one given at the start of this chapter. The reason for this is that it uses a system which can also be used for all the other secret plaits, from 3 to 21.

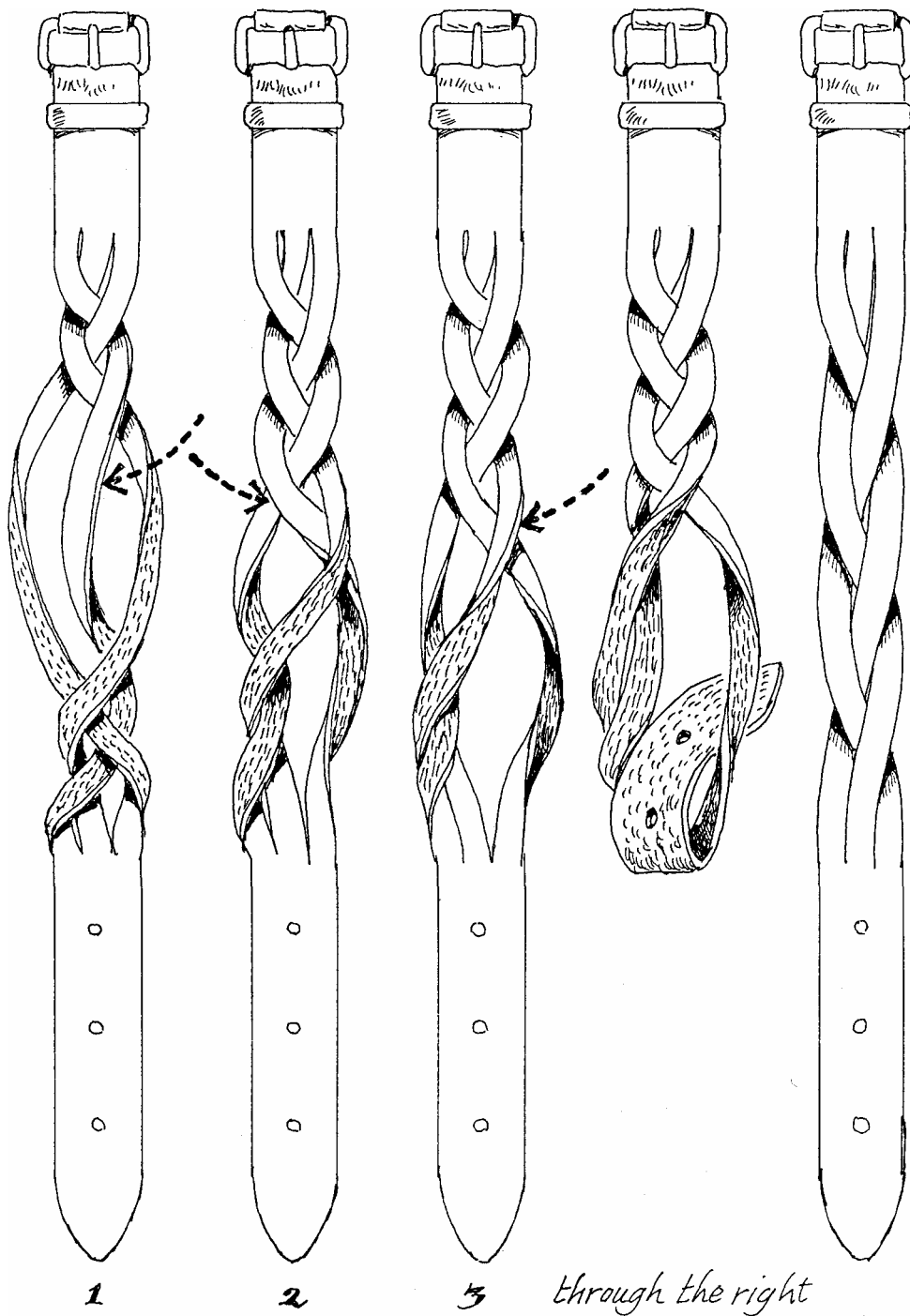

However when making up belts for our shop I sometimes get bored using the same method all the time, and often switch to this one for variety. It is neither faster nor easier, just different.  
 Instead of counting to 6 you count 1,2,3-left-1,2,3-right.

# Seven Plait

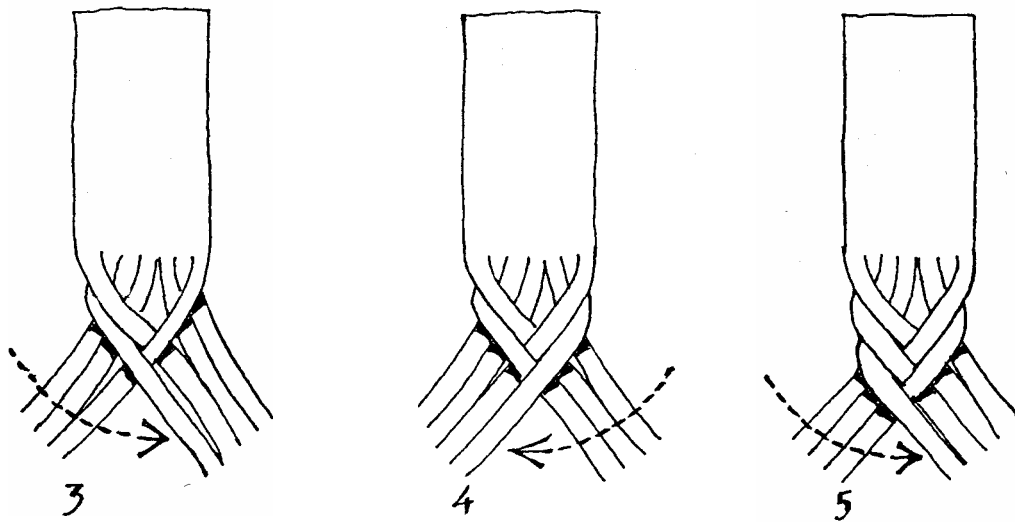
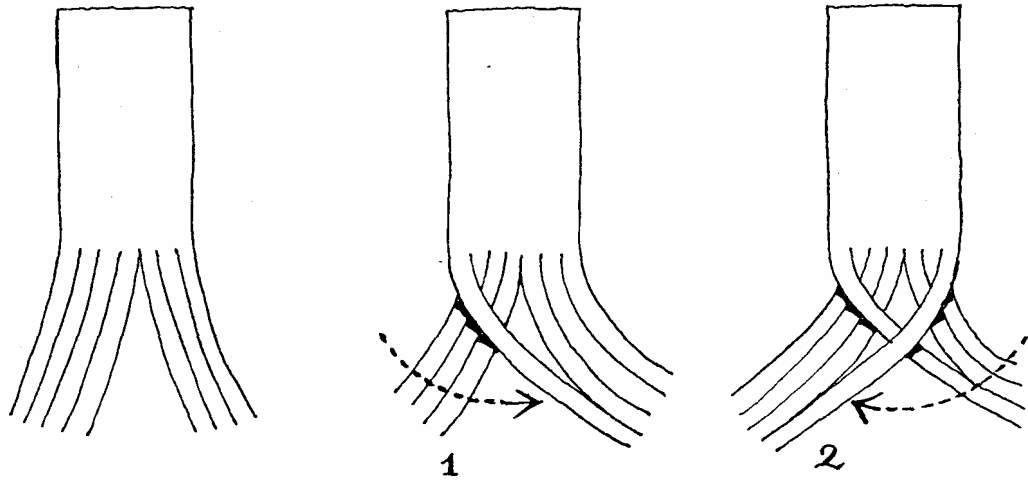

## SEVEN PLAIT

The seven plait looks so like the five plait that people will often not notice the difference. It is useful for wider belts when a close plaited look is desired.

The sequence is 1, 2, 3, 4, 5, 6, 7, through the top, through the bottom, 8, 9, 10, 11, 12, 13, 14. The sequence is repeated as often as necessary.

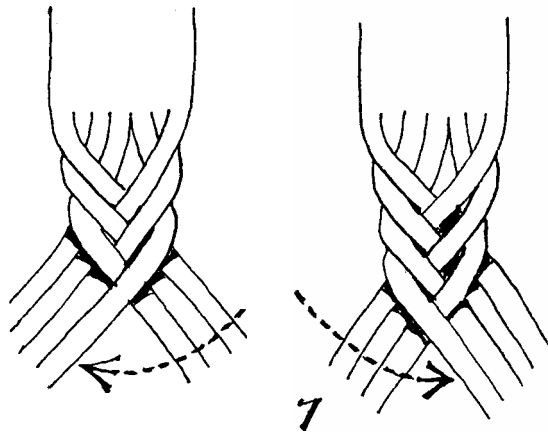

SEVEN PLAIT

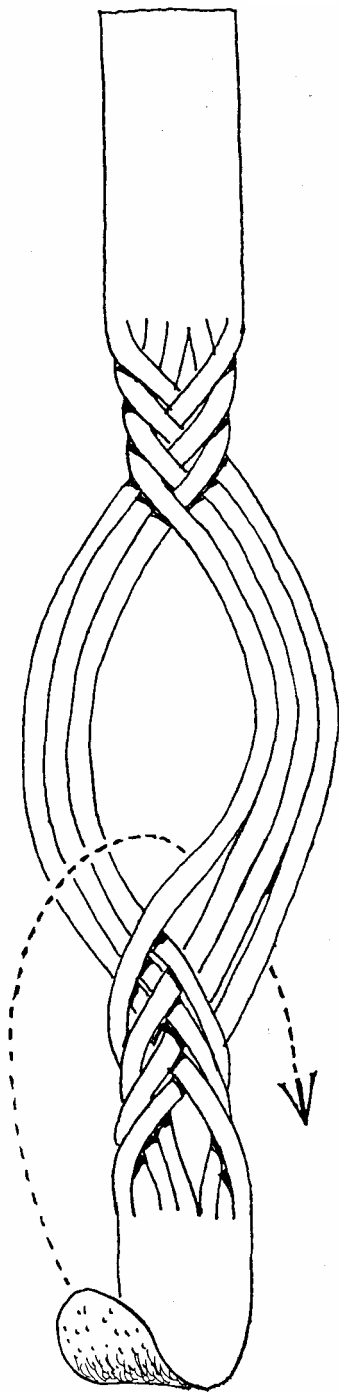

*through the top*

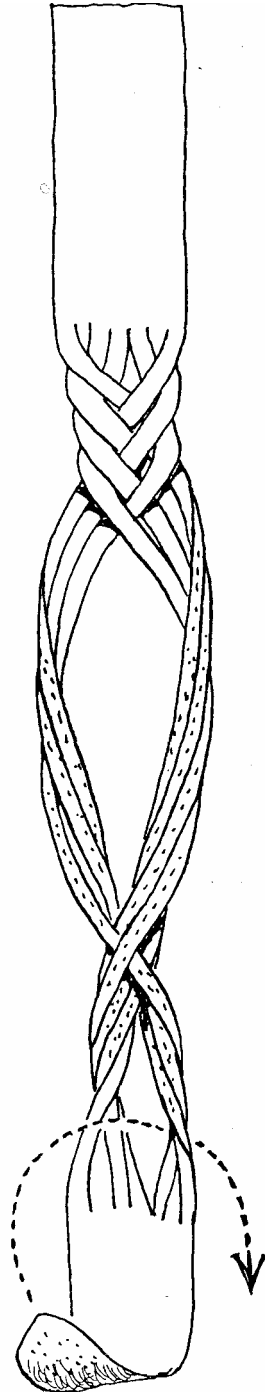

*through the bottom*

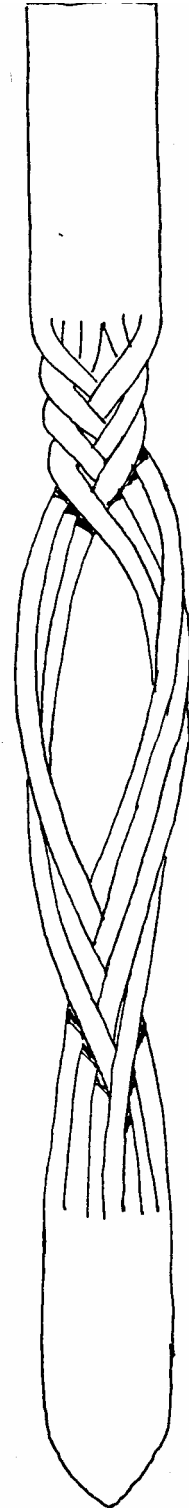

SEVEN PLAIT

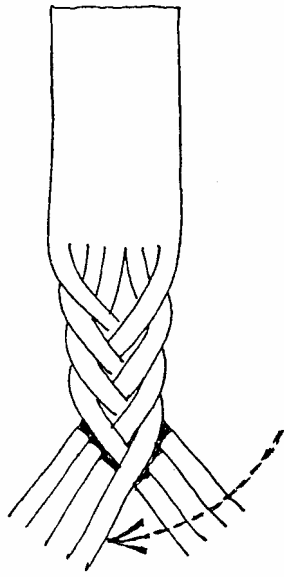

8

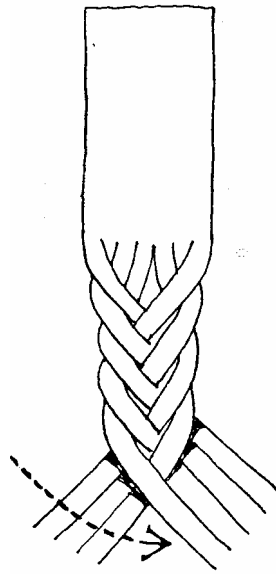

9

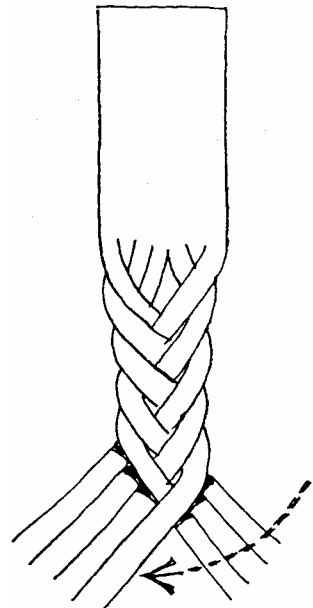

10

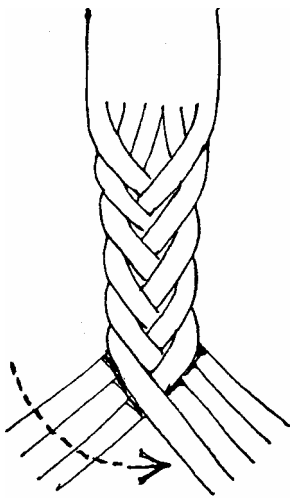

11

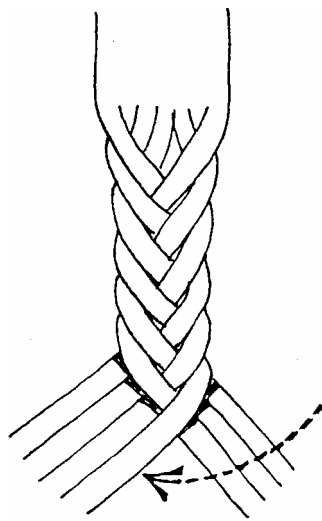

12

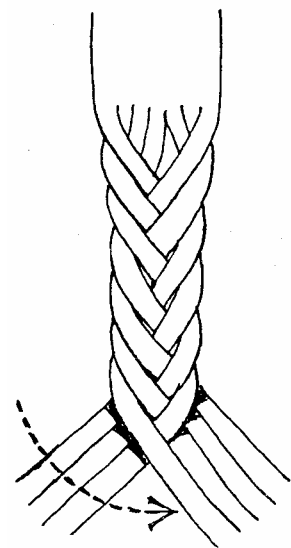

13



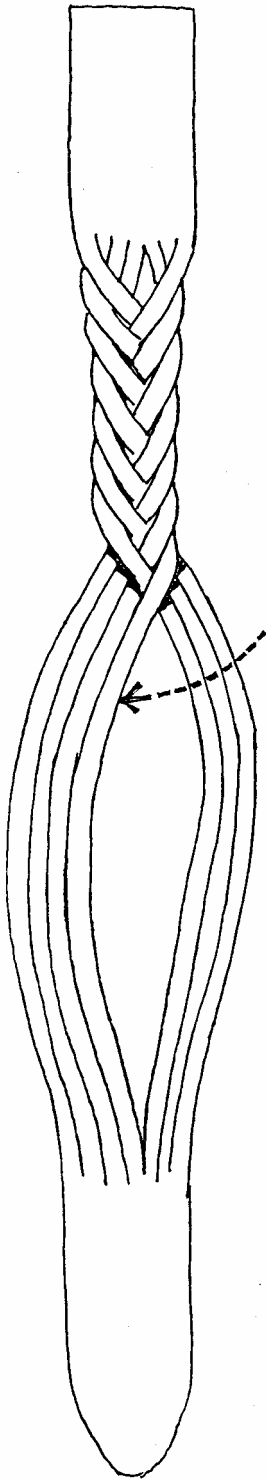

*end of sequence*

I originally worked these out to settle an argument about how many plaits were possible in the secret plait. The sketch on the cover shows a complete form of the eleven plait.

In practise these plaits are not a great deal of use because as the number of strands increase they tend to bunch up too much. However I once made a nine plait belt for a customer who wore it for years and claimed that it was very comfortable.

In theory one could continue to enlarge the number of strands (always using odd numbers) until one

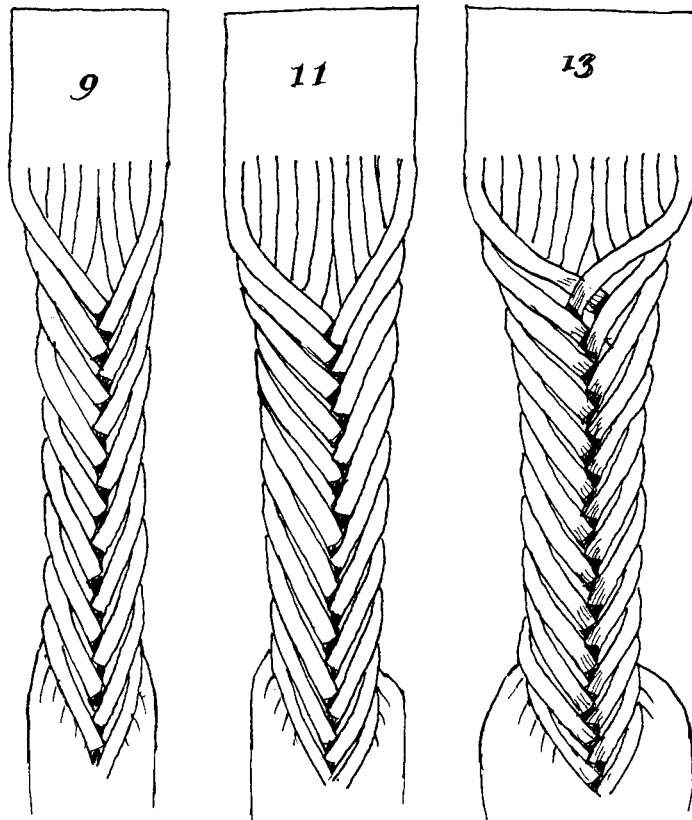

ran out of patience.

The plaits are all worked out in the same sequence as shown for the seven plait, except that the count is increased according to the number of strands being used. For instance the sequence for the nine plait is 1-9, through the top, through the bottom, 10-18. The sequence for eleven is 1-11, through the top, through the bottom, 12-22. The thirteen has a count of 26 and so on.

### HOMEMADE GANG CUTTER

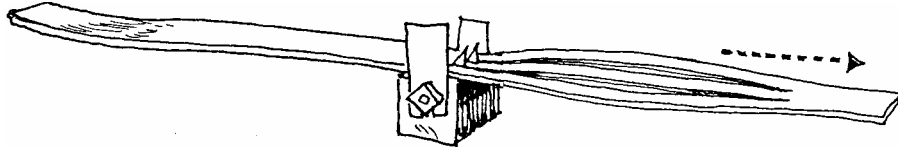

Gang cutters are small tools designed to cut a number of strands at once. Factory made ones are available to the professional leather worker who may wish to make a large number of plaited belts, but they are quite expensive.

The homemade gang cutter illustrated here costs only a couple of dollars and works just as well as the factory job. It is also easy to make.

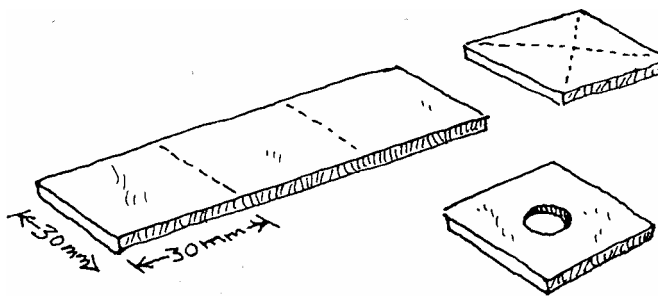

Take a 30mm wide strap and cut off sixteen or more squares. Draw a line from corner to corner to find the centre and punch a hole.

Take a bolt, 50mm is long enough, and fasten all the leather washers together, put a metal washer at one end and a scrap of tin cut as shown at the other.

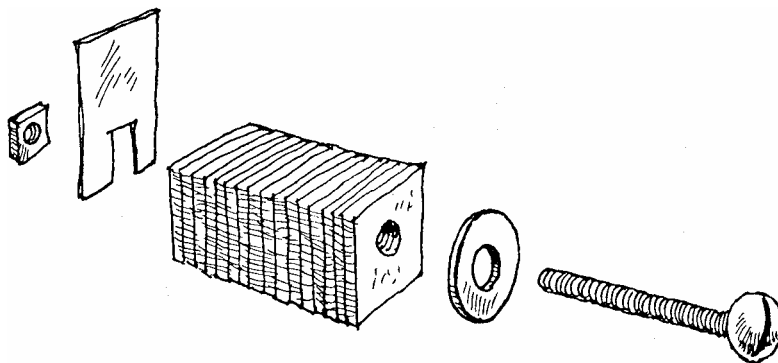

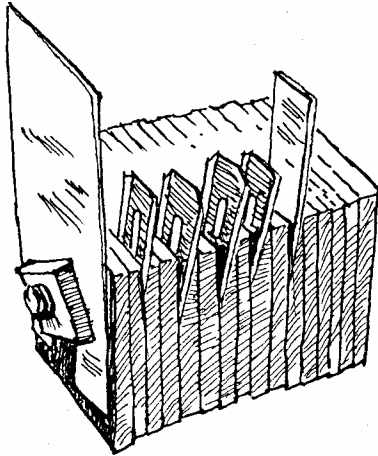

Razor blades can now be pushed in between the washers at whatever spacing is desired. Another scrap of tin is also pushed in to mark the width of the belt being cut. This helps prevent the belt wandering off line as it is being pulled through.

Begin the cuts with a knife and then put the gang cutter in a vice. Slip the belt over the blades and pull. Stanley knife blades can also be used in this cutter, and in that case the belt can simply be pushed down over the pointed ends of the blades to begin the cuts.

## Gulf Knot

Belt buckles are usually sewn to the belt or attached by rivets. However in the outback bushmen will often improvise, using a pair of rings for a buckle and an interesting knot to hold them in place. This is known as a Gulf knot in north Queensland, a Kimberley knot in the west, and has other names in other areas.

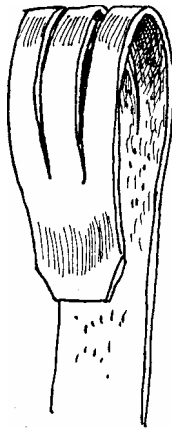
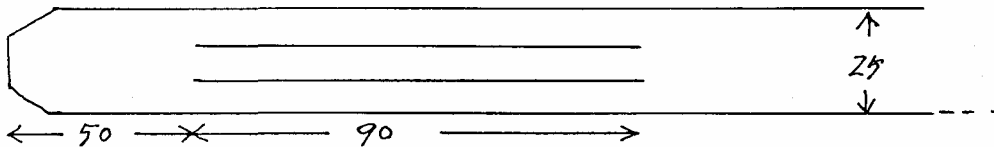

Three or four slits are cut into the leather as shown. The actual measurements vary according to the thickness and flexibility of the leather, so it is best to first practise on a scrap if you want a neat job.

## THE GULF KNOT

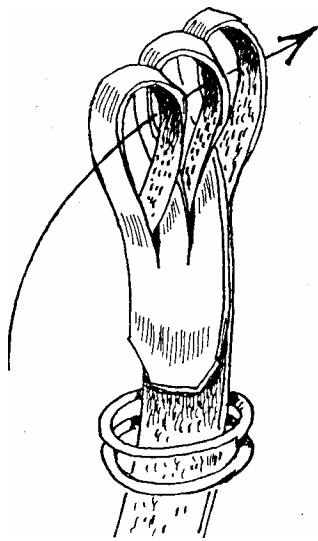

The strands are twisted to form a number of loops and the end of the belt is pulled through.

The back of the belt will now look like this.

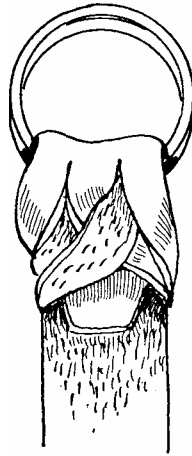

This is how the should look.

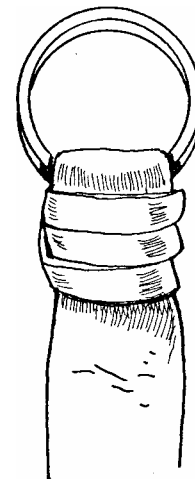
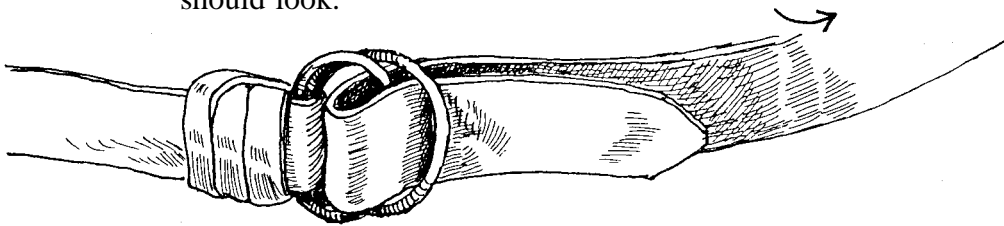

To fasten the belt it is passed through both loops and then back through one.

## Trinity Knot

This fastening was first shown to me by Hienz Berger of Trinity Beach, north Queensland. It is not very often seen, and yet it works well. The sketches show it being used for a dog collar, and the measurements will need to be enlarged slightly when using wider leather.

When making a belt the metal ring is not needed. A pair of rings can be used instead of the buckle, and in this case only two slits need to be made in the leather.

It sometimes takes a little manipulation to get the two leathers locked together as shown in the last sketch. Note also that only the good side of the leather is showing when the fastening has been properly fitted together.

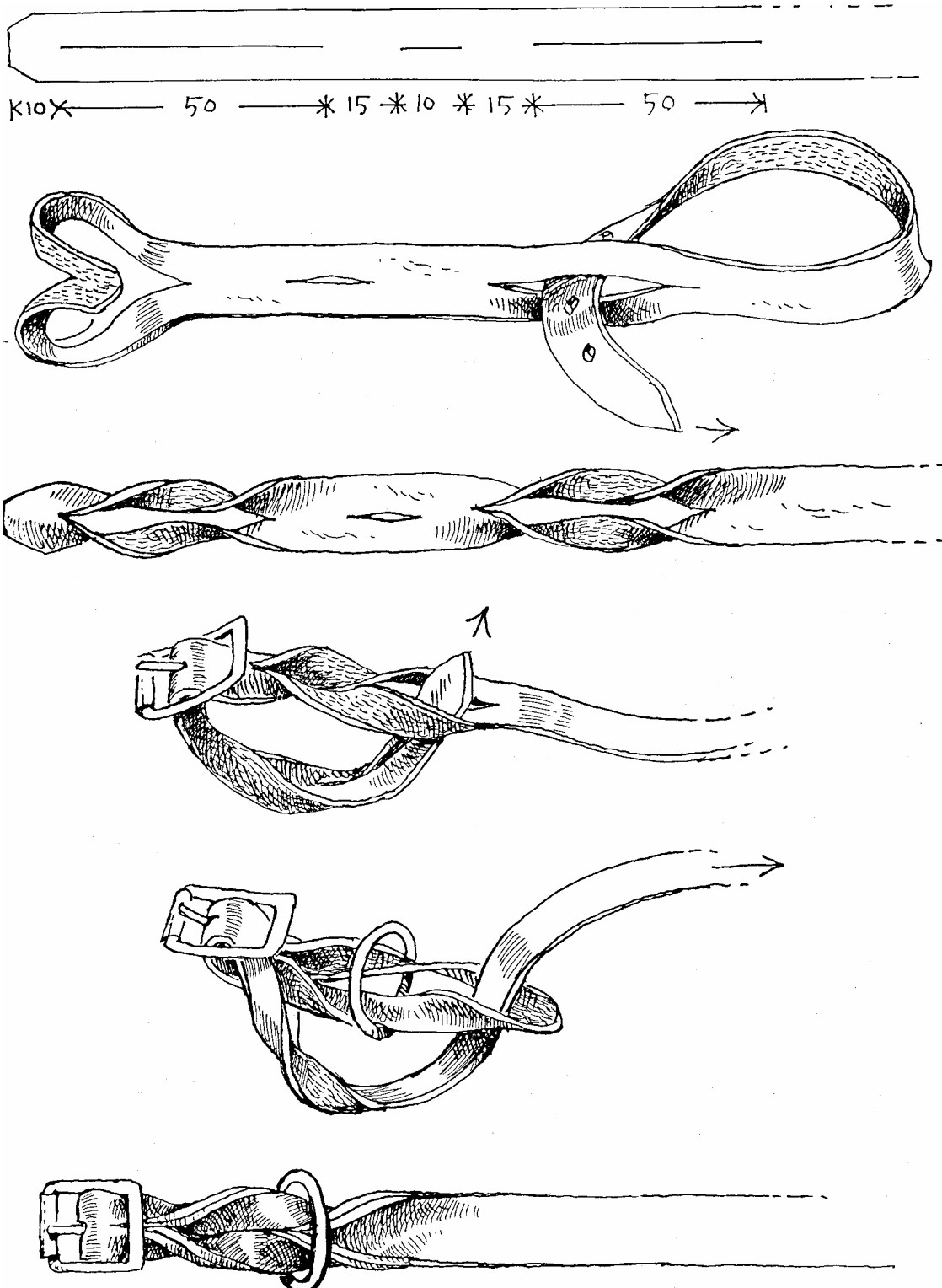

Trinity Knot

# 4

## Bushmans' Belt Pouches



POUCHES SEWN ON THE BELT

There are two schools of thought as far as sewing pouches directly onto the belt. Some stockmen dislike the idea firstly because the belt will no longer fit through the loops on their trousers, and secondly because they can no longer use their belt to temporarily tie up the legs of a beast while they are working with it. Those who like their pouches sewn to the belt claim that they tend to lose loose pouches, and they sometimes can be seen wearing two belts, one to hold up their trousers

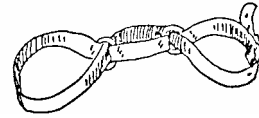

and also be used during cattle work, and another on which pouches for their working tools are sewn.

The belt without the pouches sometimes has a couple of rings placed in it as shown. By taking the end of the belt through these rings a stockman can make up what are known in this part of the country as 'dinner-camp hobbles'.

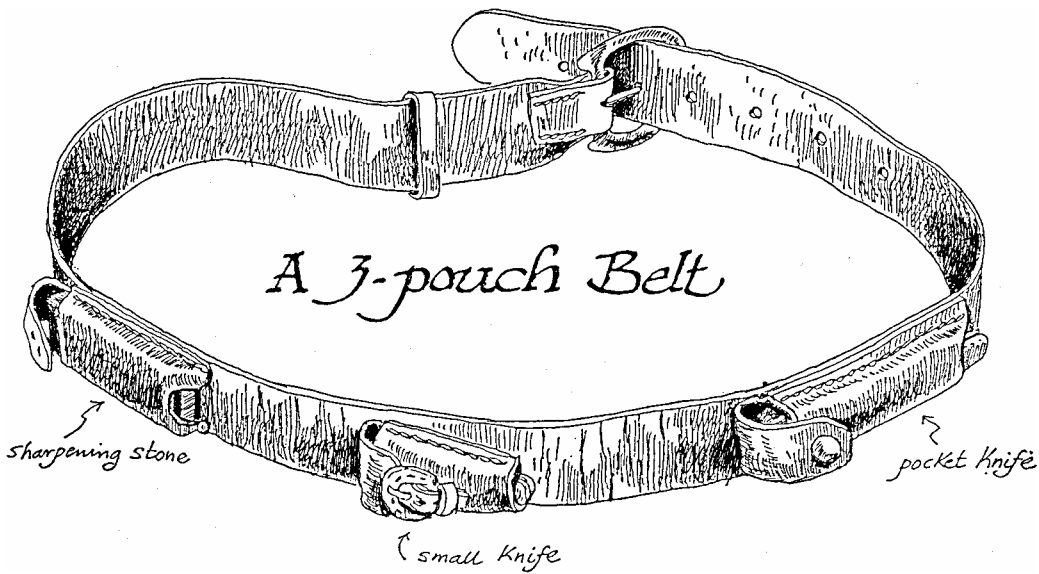

This typical stockman's belt with three pouches was lent to me by Lee Bones of Kuranda. It is quite an old belt, and made by a bush craftsman.

On the left of the sketch there is a pouch for holding a small sharpening stone, a very important

item when knives have to be kept with a razor edge.

The stone measures 76x26x6 mm, and the pouch was made a snug fit.

The buckle has come adrift on the belt, but the stitching holes show where it was placed.

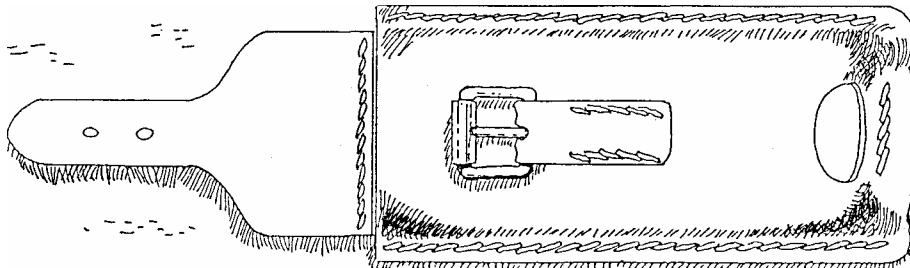



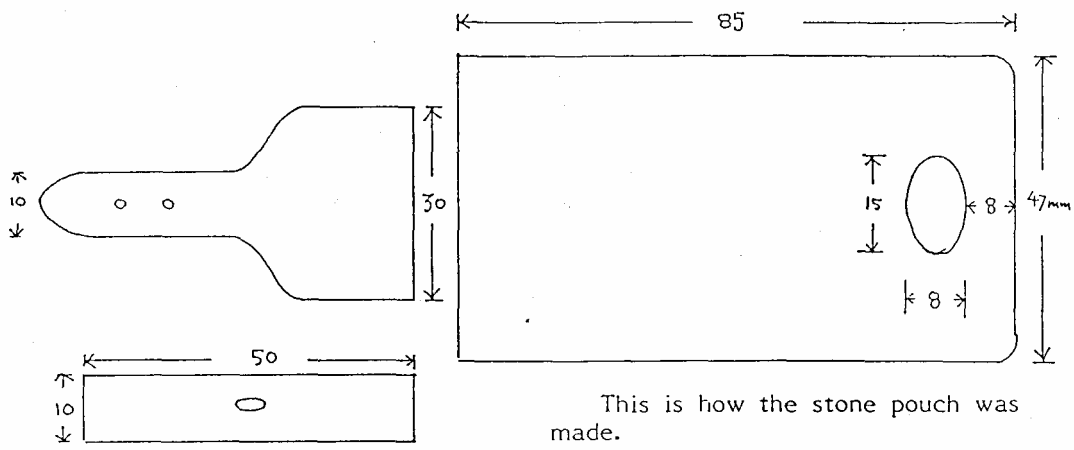

This is how the stone pouch was made.

Some stockmen are a bit fussy about cutting up their food with the same knife that they use for castrating a beast, and so they carry two penknives.

The castrating knife is usually the smaller knife, and has to be kept razor sharp. The pouch for this can be seen in the centre of the sketch.

This pouch features a handsome

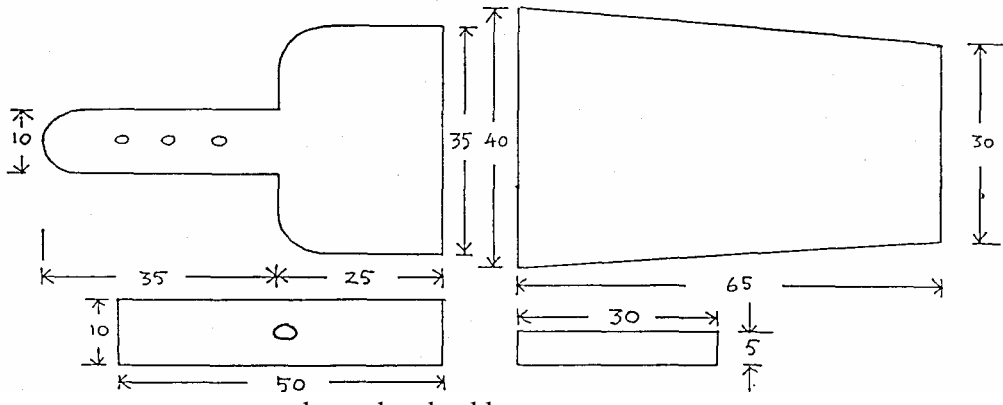

horseshoe buckle.

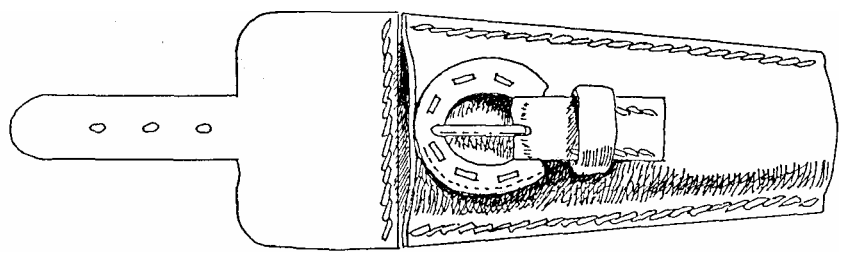

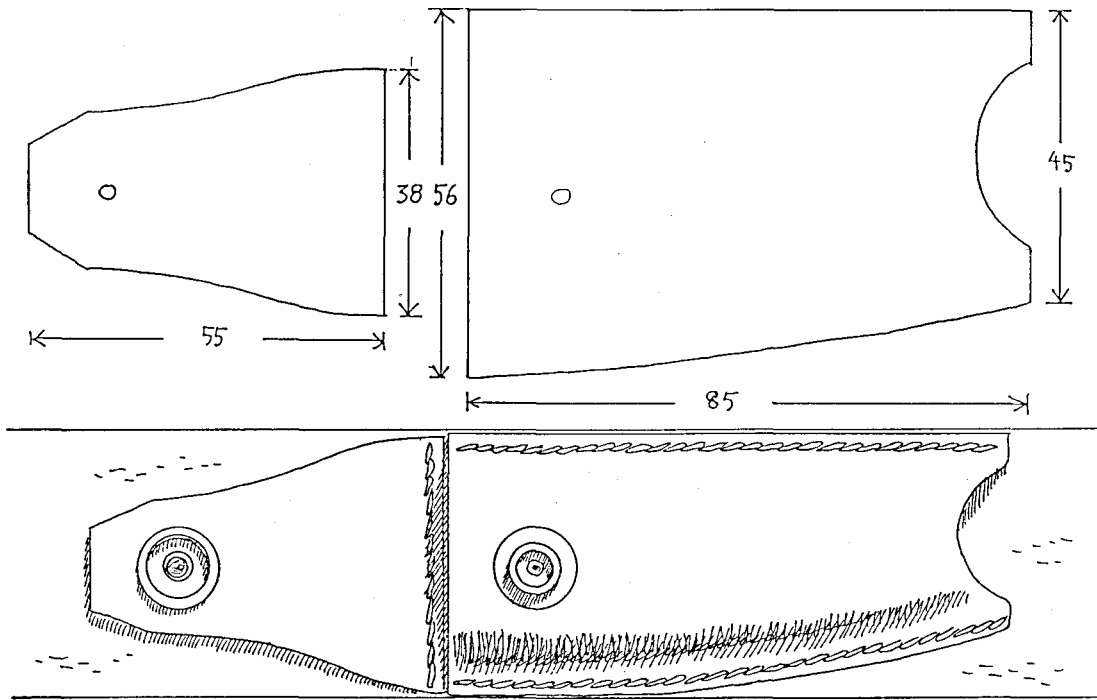

The dimensions for the larger pouch are given here, but in fact these pouches are not made to any dimensions. Instead the leather is wetted and then formed over the knife. In this way a good fit is guaranteed.

This pouch is fastened with a press stud. There are various types of press stud available, this is the most popular of the larger ones and is known as a large durable.

used and a small anvil

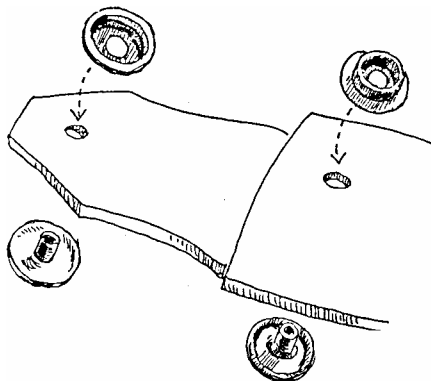

It is made up of four pieces as shown. Holes are first punched in

the  
leather  
and  
a  
setting  
tool  
is

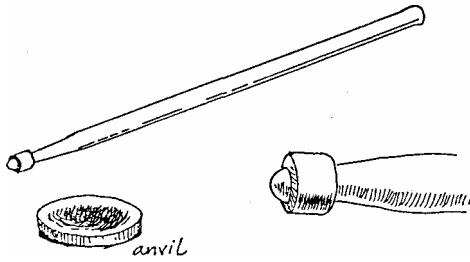

An anvil can be improvised by carving a hollow in a scrap of timber or hammering one into a lump of lead.

The setter can also be improvised from a large nail, but it is easier to buy one.

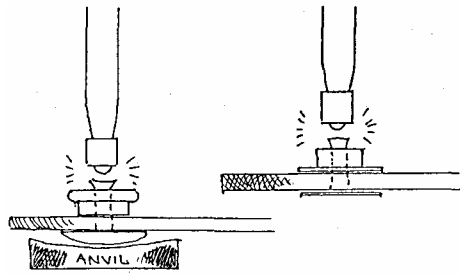

The press studs are put together as shown, using a hammer to strike the setter. Do not use too much force or the stud will distort and not make a good fit.

The problem with using this type of press stud on a belt pouch is that sometimes after a lot of use they will come loose, and spring open when only rubbed accidentally.

Once open the knife can easily slip out and become lost. The only way to avoid this is to make the knife a tight fit in the pouch.

As explained a little further on this is done by moistening the leather used to make the pouch and forming it over the knife. When sewn down the pouch will be an exact fit for that knife.

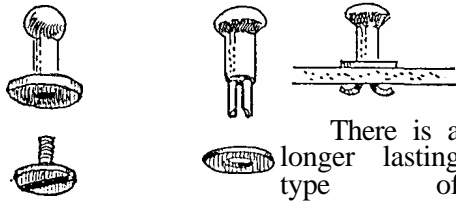

There is a longer lasting type of fastener that has no moving parts, and is usually known simply as a pouch stud.

The sketch shows two sorts that are available at present, but unfortunately not all saddlers stock them.

The one on the left is in two pieces which simply screw together. The one on the right has two legs which are hammered over to attach the stud to the leather. Note that the washer goes on the top side of the leather.

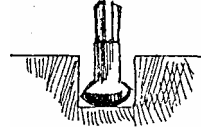

It is best to hold the head of the stud in a vice when hammering over the legs. If no vice is available the head of the stud can be dropped into a hole drilled into a piece of timber.

Use something round, such as the shank of a screwdriver, to first open out the legs before hammering them down.

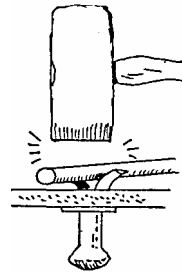

### POUCH WITH A STUD

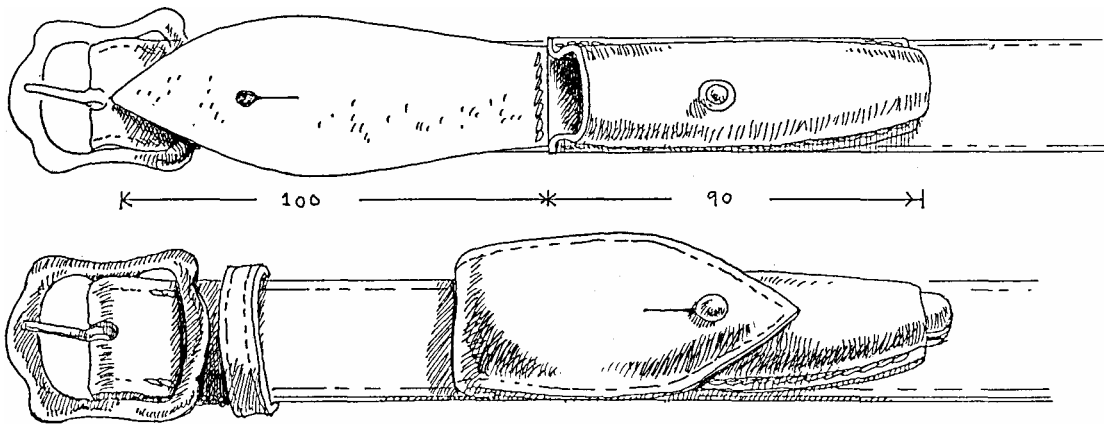

This sketch shows a pouch attached to a belt, the flap held down with a pouch stud.

The flap has a small hole punched in it, and a small slit joins the hole. The hole is smaller than the head of the stud.

When done properly the flap will fasten easily, but will not come undone by itself. I have worn a watch pouch with such a stud for years and never had it come undone accidentally.

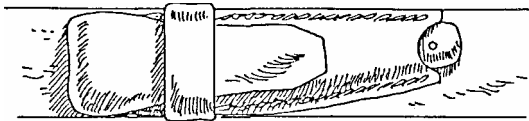

In the bush fasteners are often not available, and even when they are some bushmen prefer not to bother with them. Instead they rely on a tight keeper and a long flap to keep the pouch covered.

POUCH WORN ON THE FRONT

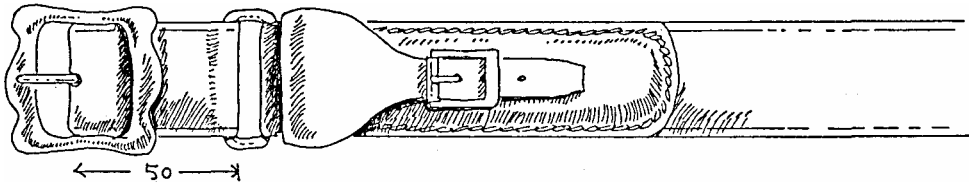

The sketch of the belt from the back shows more details of the construction.

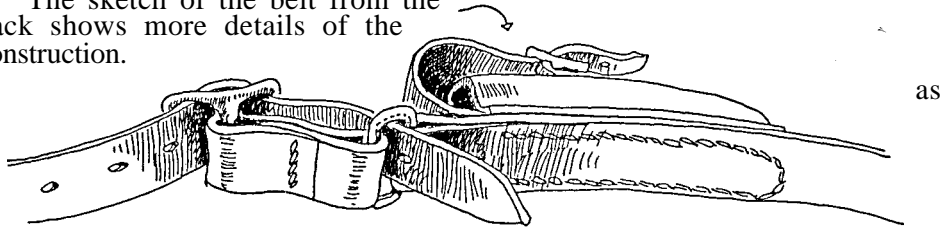

The main problem with sewing pouches directly onto the belt is that the belt will then not fit through the loops on your trousers.

The only cure for this is to fix the pouch close to the buckle end of the belt.

However this creates another problem, because the loose end of the belt will then cover the pouch when it is done up.



There is a neat answer to this problem. A short distance from the buckle a ring is fitted to the belt.

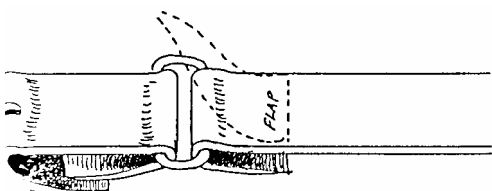

This can either be circular or rectangular.

The end of the belt is pushed through this ring, and lays against the body out of sight, so that the pouch is not covered.

Construction of the belt is quite simple. The belt is first put together

shown. If desired the flap of the pouch can also be sewn on with the same row of stitching that secures the belt to the ring.

In this case the pouch has been made to fit any shape of knife. A piece of timber is shaped as shown.

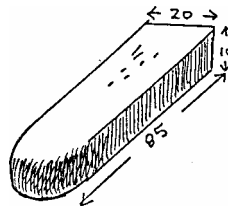

A scrap of leather is then soaked in water for a short time, tacked over the wood and left to dry.

When dry the tacks are removed and it is trimmed to shape and sewn onto the belt.

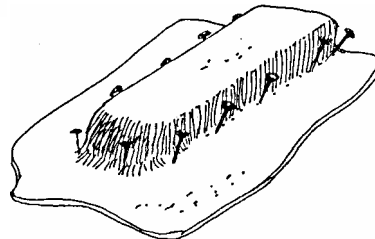

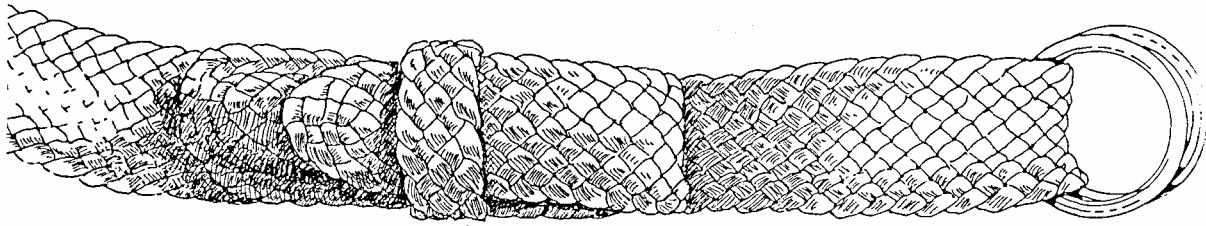

## Plaited Knife Pouch fixed to Belt

### MATERIALS NEEDED

4.5mm lace used for the job.  
 Flap, 5 at 400mm = 2000mm.  
 Front, 7 at 450mm = 3450mm.  
 Sewing on front = 800mm  
 Keeper, 3 at 350mm = 950mm

TOTAL 6900mm(23 feet)

This handsome knife pouch is permanently attached to the belt. It looks best if it is made with the same lace that was used to plait the belt. The techniques used for the pouch are the same as for plaiting a belt. I would not recommend this pouch to anyone who cannot already plait a belt.

However there are bound to be readers foolish enough to attempt this project without any previous experience, and so for their benefit I am including a small segment showing how a belt is begun.

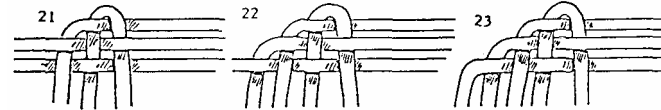
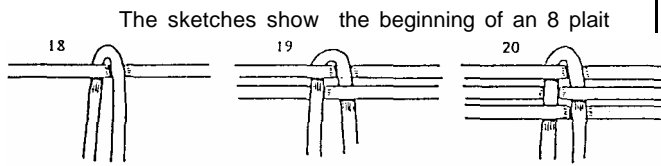

belt. To do a 10, 12 or 16 simply add in more strands as

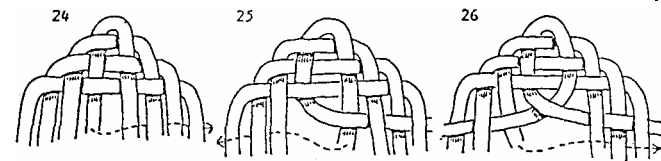

desired. The first strand of lace is looped around the nail, making sure that the good side of the leather is facing upwards

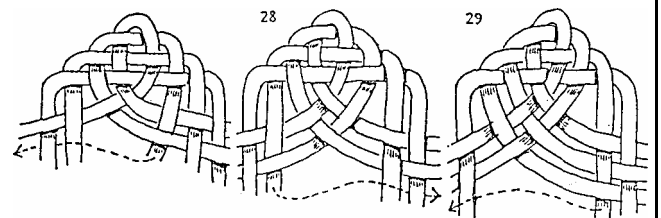

all the way around.

Beginning on the left side at the top turn down all the strands in an under-over-under sequence.

The right side is then turned down in the same way. Now the centre left strand is moved across as shown by the dotted line, then the right side inner strand is brought across as shown in the next drawing.

27

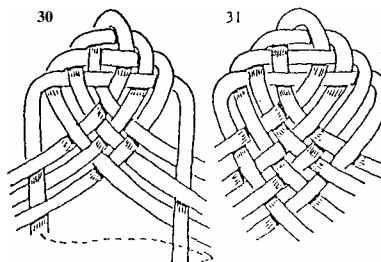

Each strand is brought over in sequence. Once this has been done the work can be removed from the nail and carefully pulled firm to make the point of the belt.

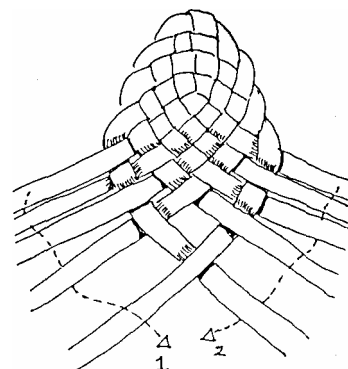

THE  
POUC  
H  
FLAP

Begin an ordinary 10 plait belt using 5 strands of 4.5mm lace, each 400mm long. (All the measurements are for an ordinary pocket knife 100mm long, and will need to be adjusted for longer or shorter knives.)

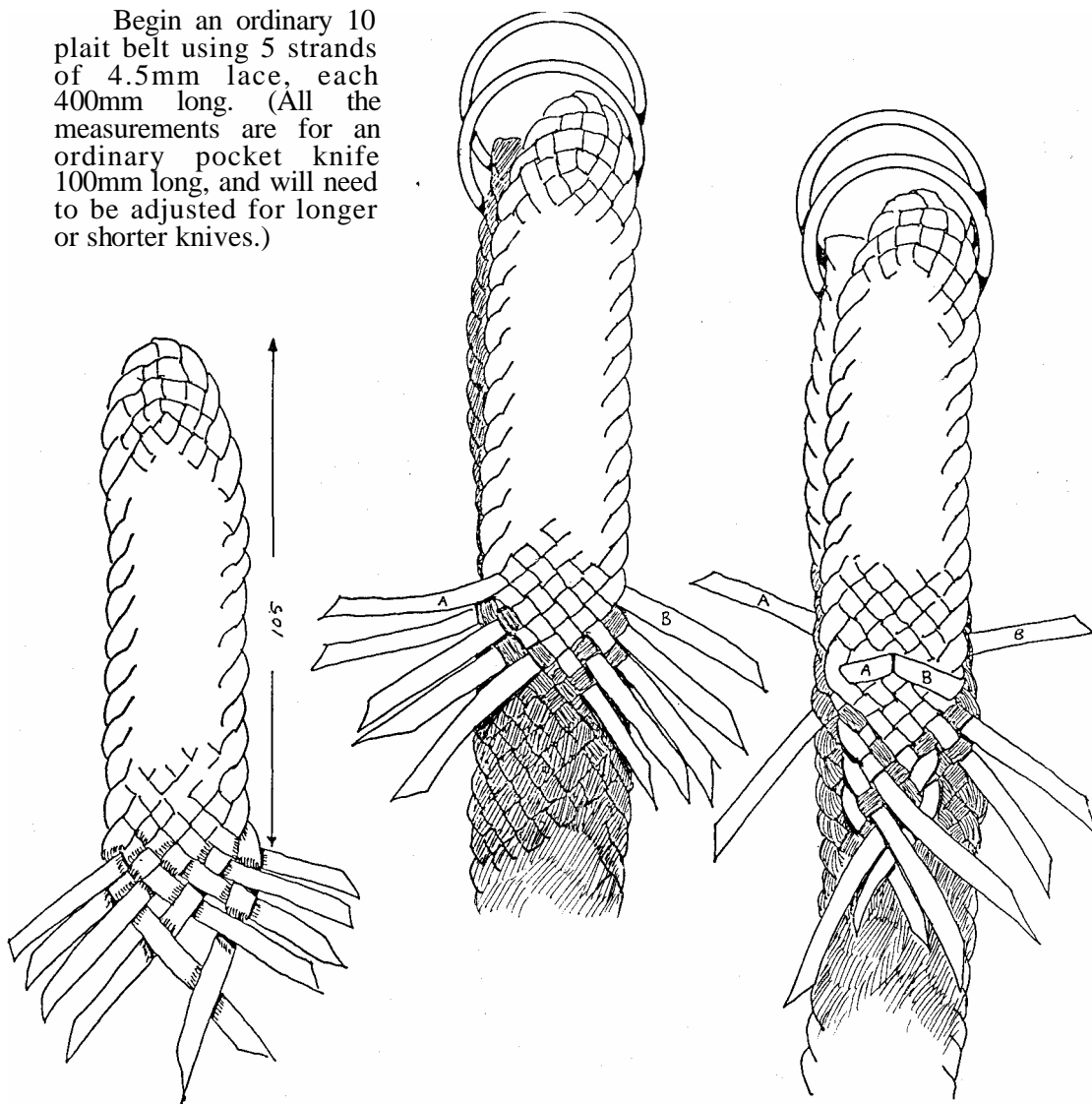

Complete 105mm of plaiting.

Begin fixing the ends into the belt about 100mm from the rings. Note that the strands marked A&B have not been fixed in.

The strands marked A&B are taken right through the flap and also the belt, and are then worked into the back of the belt. This is necessary so as to anchor the flap in the middle.

When weaving in the other strands try and keep them away from the edge of the work, otherwise this looks thick and clumsy when the job is completed.

Weave the strands in far enough so that they will not pull loose.

Trim off flush and the flap is complete.

#### FRONT OF THE POUCH

The front of the pouch needs 7 lengths of 4.5mm lace, each 450mm long. This will be worked into a 14 plait.



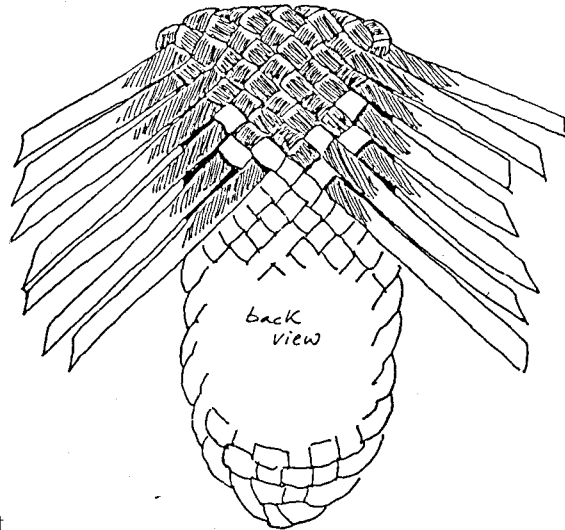
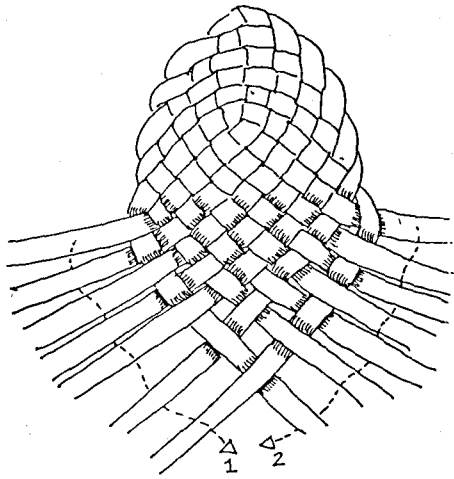

Begin an ordinary belt plait, but before going too far try it over your knife for size. Some knives, such as the 'Old Timer', are wider than normal and may need an 18 plait to cover them.

Turn the end over and fix the first few strands. As before try and not work strands across to the very edge.

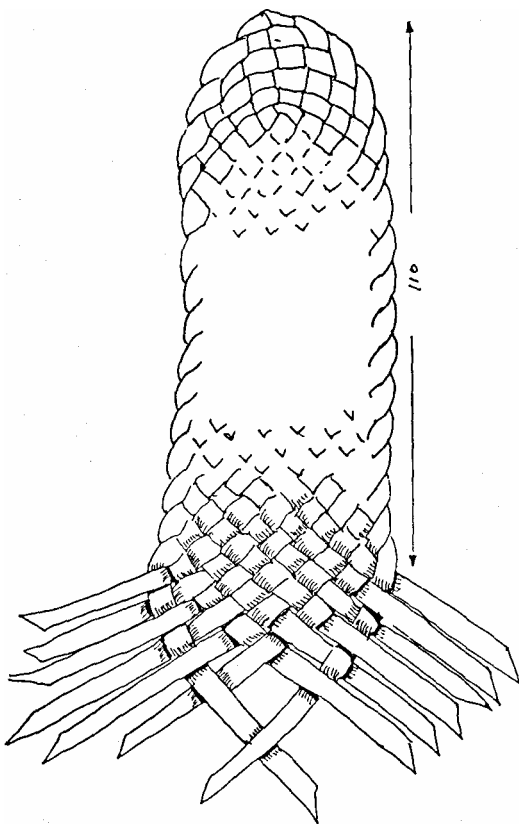

Complete 110mm of plaiting.

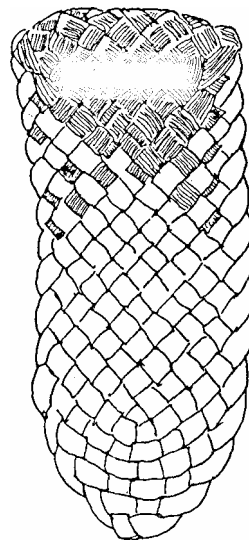

The shaded section shows the good side of the leather after it has been worked into the back and trimmed off flush, note how the edge has been kept clear.

The front of the pouch is now complete.

## SEWING FRONT TO BELT

Take 800mm of 4.5mm lace and fix a needle to it, or use a lacing fid to open up the strands.

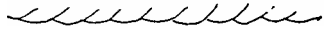

Work the lace into the back of the belt as shown. This will stop the lace pulling out under pressure.

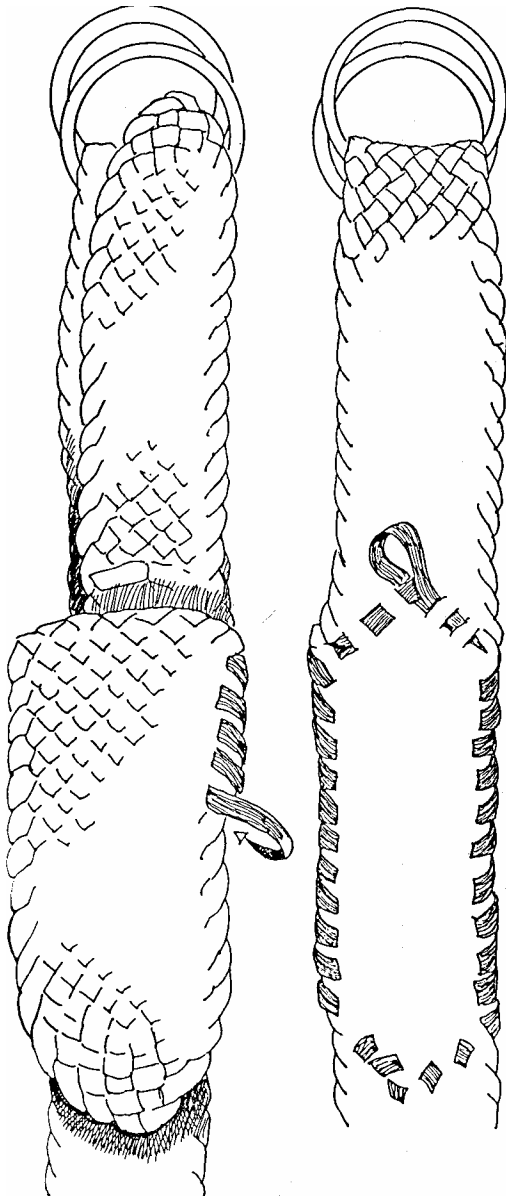

Lace the outer edge of the front to the outer edge of the belt. This is a straight forward job along the edges, but care is needed when going around the bottom of the pouch to get a neat row of lacing

If done carefully the lacing will appear to be part of the plaiting.

The lacing is finished off by doubling it over in the same way that it was started.

## THE KEEPER

The keeper needs 3 strands of 4.5mm lace, each 350mm long. It is set 25mm from the opening of the pouch.

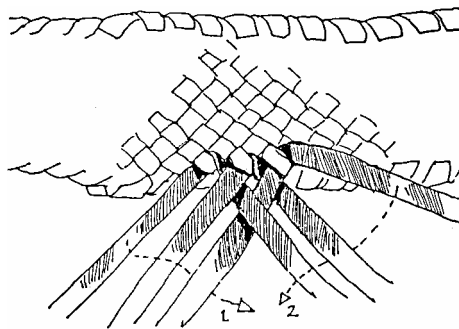

Work the three strands into the back of the belt as illustrated and begin plaiting an ordinary 6 plait.

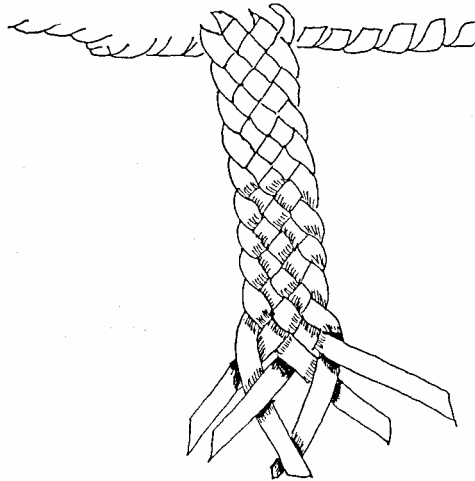

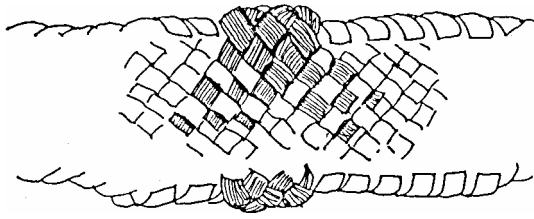

Put your knife into the pouch and keep plaiting until the keeper is long enough to cover it and come around to the back of the belt.

Work the ends into the back of the belt and cut off flush. pouch is now complete.

#### MATERIALS NEEDED

All 4.5mm lace; Front, 9 at

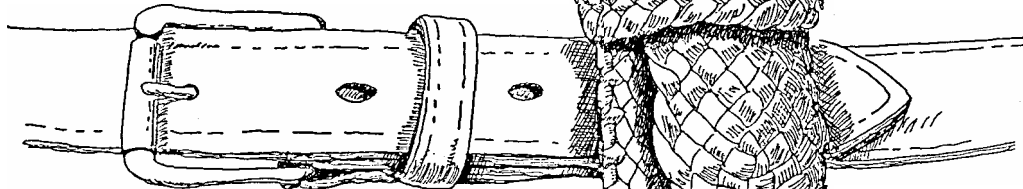

500mm = 4500mm Back, 6 at

## *Plaited Knife Pouch*

650mm = 3900mm Keeper, 3 at  
 400mm = 1200mm Lace for sewing = 900mm TOTAL = 10.5metres

This pouch looks very fine, and should present no problems to anyone who can already plait a belt.

The front part is plaited in the same way as described for the previous pouch.

In this case the knife was 100mm long, but wider than the previous

knife, and so the front was made with an 18 plait, using 9 strands each 4500mm long.

#### PLAITING THE BACK

The back uses 6 strands, each 650mm long, and is worked as a 12 plait. It begins as for a normal belt, and is plaited for 125mm.

The centre four strands are worked into a 4 plait.

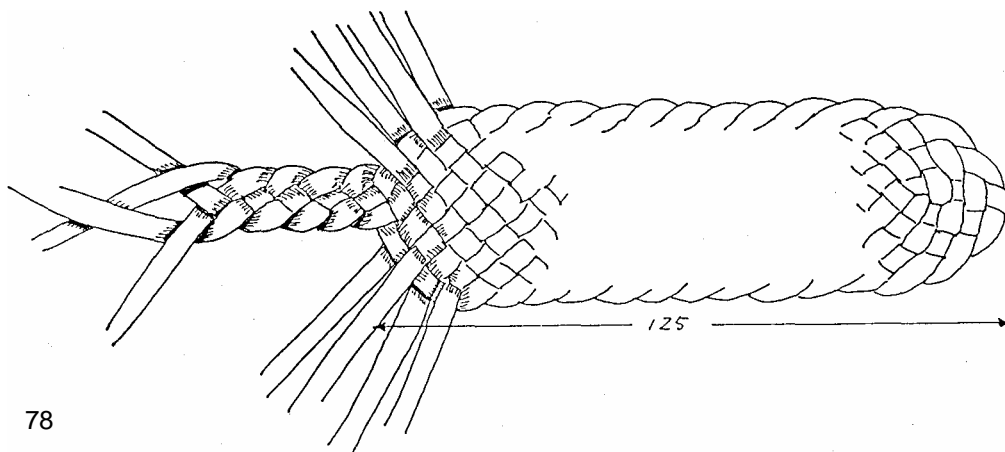

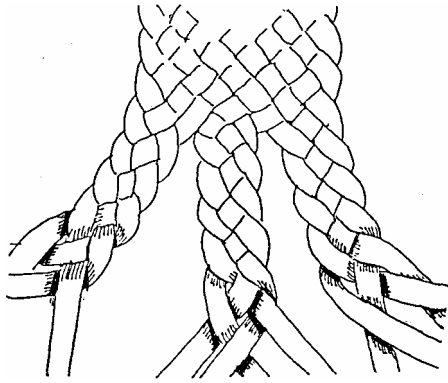

The outer strands are also worked with a 4 plait.

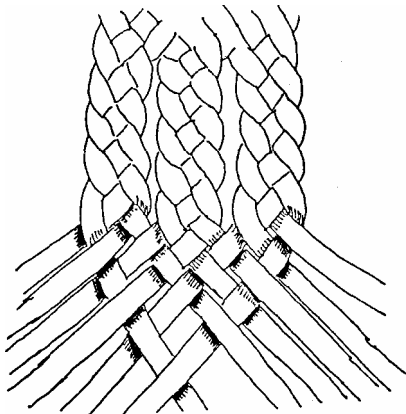

The strands are joined once more into a 12 plait, leaving two slits in the plaiting through which the belt will fit.

Try and make the slits just long enough to make a neat fit around the belt you intend to hang the pouch from.

Continue plaiting until the total length is 200mm.

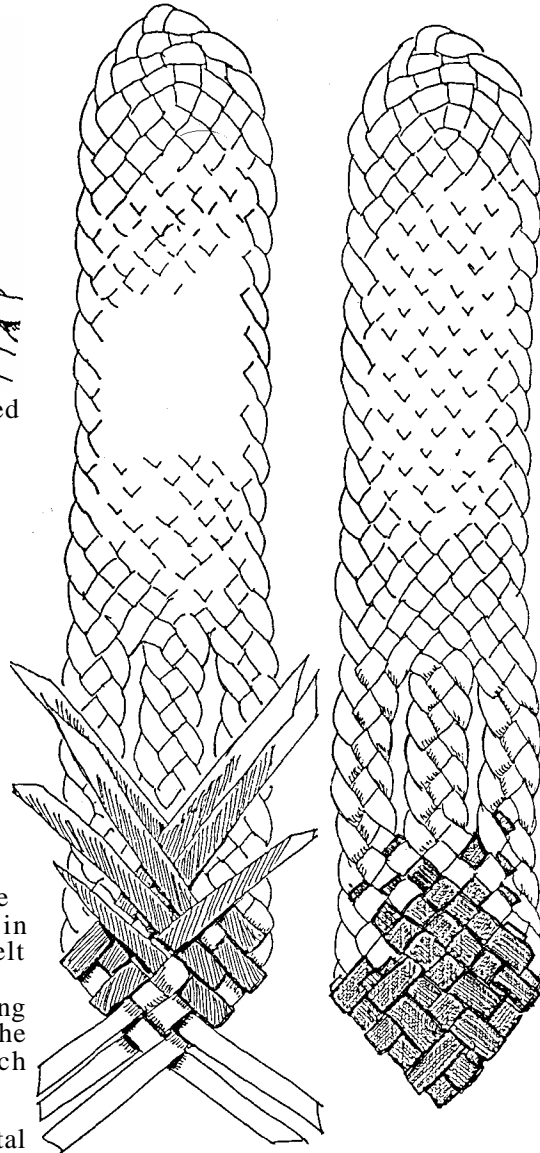

Begin tucking in the loose ends. This will be out of sight inside the pouch on the finished job.

Work all the ends in as neatly as possible and trim off flush. The back

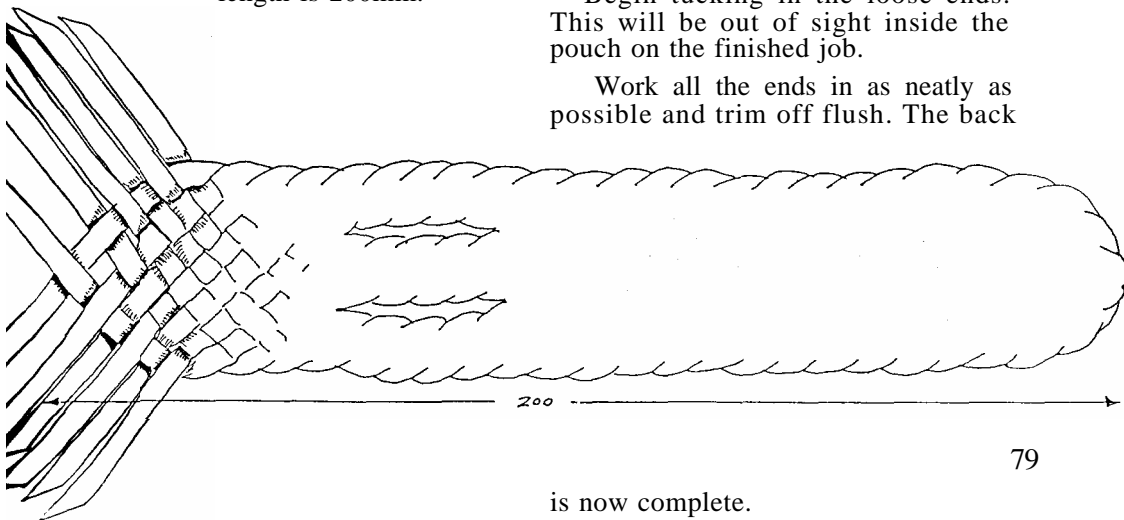

is now complete.

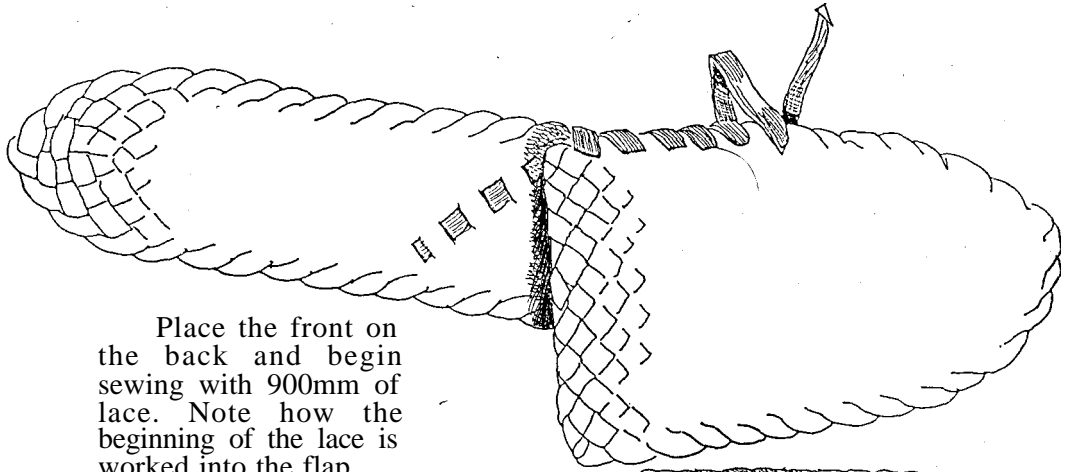

Place the front on the back and begin sewing with 900mm of lace. Note how the beginning of the lace is worked into the flap.

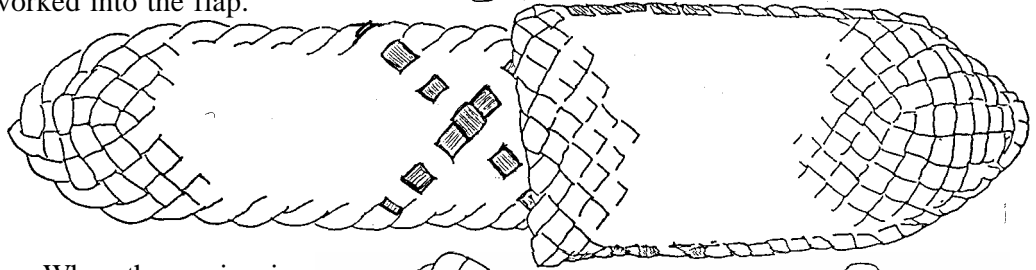

When the sewing is completed the end of the lace is worked into the flap in the same way as the beginning.

#### THE KEEPER

Take 3 strands each 400 mm long and tuck them under strands at the back of the pouch.

Plait a 6 plait right around the front of the pouch.

Plait the ends into the back of the pouch to secure them and trim them off flush. The pouch is now complete.

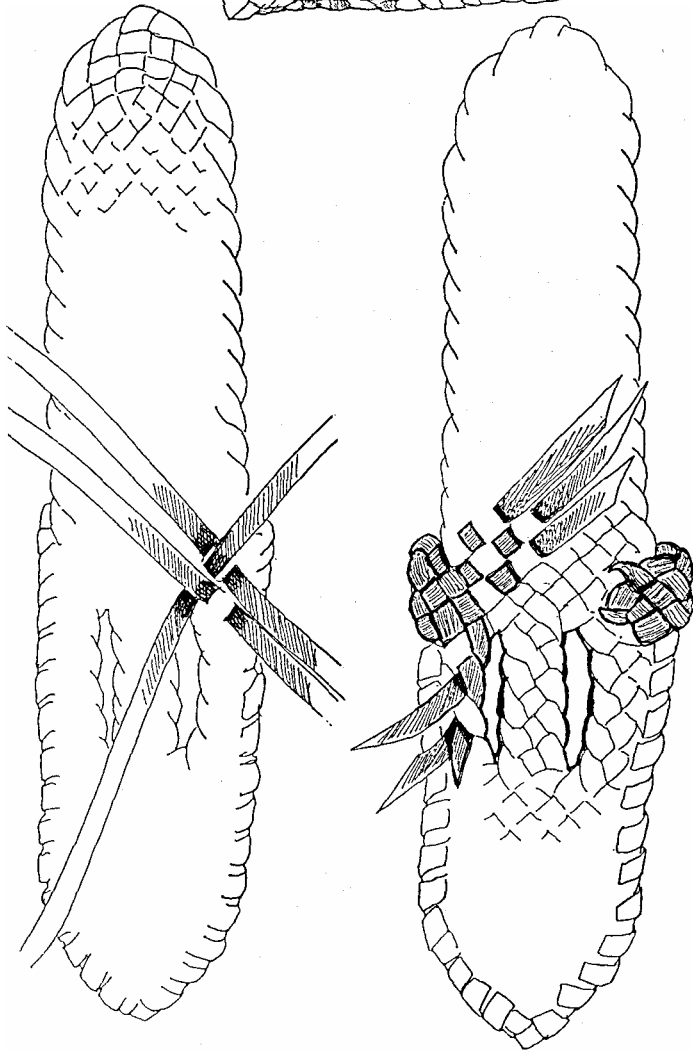

NOTE. You may find it more convenient to use press studs on this pouch instead of a keeper.

# Standard Knife Pouch

This is the most common knife pouch found in the bush, and is also the easiest to make.

It is open at the bottom as well as the top, and this is necessary because the pouch is made such a snug fit that the knife usually has to be pushed up from below to release it.

Being such a tight fit the belt can be thrown on the ground with the pouches attached and the knife will never slip out.

However, strange things can happen under pressure. I was talking to a stockman friend recently about knife pouches and he said that they used to sew the pouches on the back of the belt, but slip the belt around when wearing it so that the pouches were at the front and easy to get at.

One day he was manhandling a very large and heavy pole into a hole, and in the course of this the three knives that he was wearing must have been forced through the bottom holes in their pouches and dropped into the hole.

He did not notice them missing until he had filled and rammed the post in place, and he said that as far as he was concerned they could stay there.

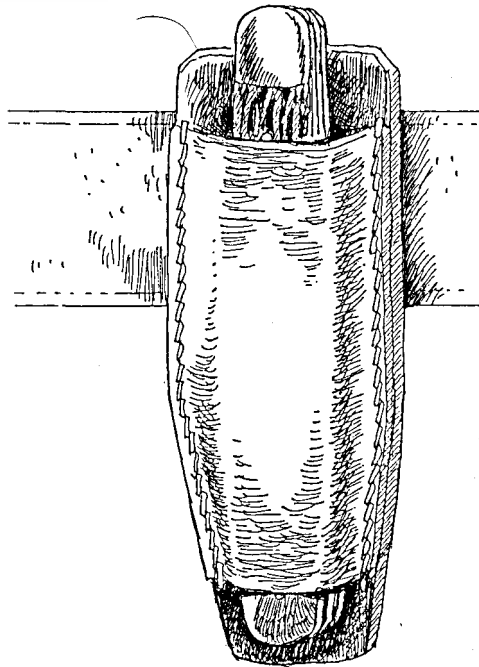

Saddlers make pouches like this from whatever scraps of leather they have laying around. The back is best made from thick leather of around 4mm or more, while the front and flap are usually of 3mm leather.

Even if you only have one side of leather to work from it is still possible to select a heavy scrap from the shoulder and lighter leather on the belly.

The dimensions given here are only a rough guide as each pouch is made to fit a particular knife.

Lay the knife on the heavy scrap of leather and mark around it leaving a space of 6mm all around, but

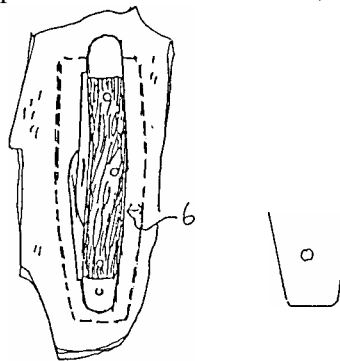
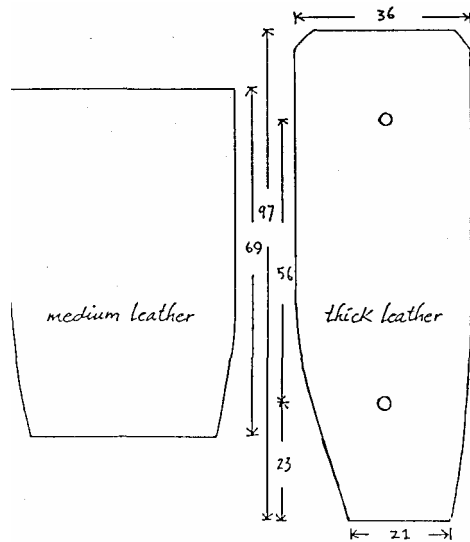

remember that the pouch cannot taper in at the top or it will be impossible to remove the knife.

Cut out the piece and punch two holes in it.

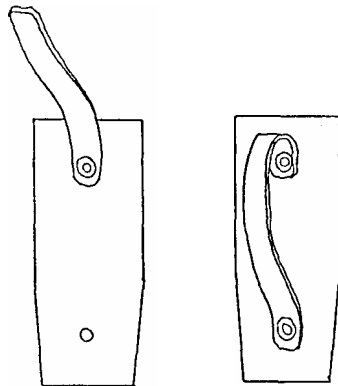

Attach the belt loop to the top. Either sew it on or use copper rivets. These drawings were made from a pouch that I have had for 24 years, and it is still in perfect condition. If it had been made with steel rivets it would have lasted only two years in our humid north Queensland climate.

If copper rivets are not obtainable it is possible to burr over both ends of heavy copper wire to make a rivet or, better still, use copper nails and roves of the type used in boat building.

It is also possible to simply cut two slits in the leather to take the belt, but this is not as good as having a separate loop.

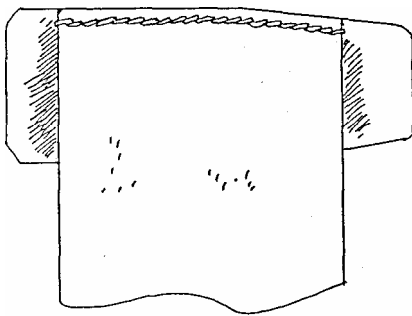

The top leather is thoroughly soaked in water and then sewn onto the thick leather. The thick leather is left dry.

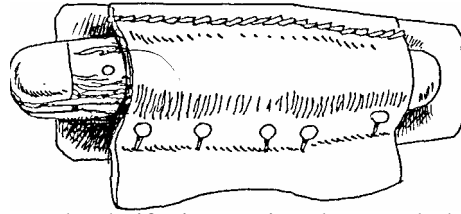

The knife is put in place and the moistened leather is shaped over it and held down with tacks.

Saddlers use a piece of bone for this work, but any smooth object will do the job.

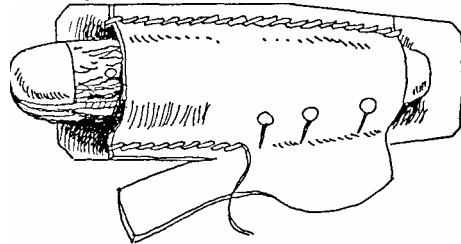

As this side is sewn the tacks are removed as the stitching progresses.

The waste leather is trimmed over and the pouch is complete.

#### FASTENING LEATHER.

**SEWING.** This is the best method. Use waxed linen thread and two blunt harness needles. An awl is used to make the holes.

**COPPER RIVETS.** These are the only rivets worth bothering about as they are strong, long lasting and do not rot or stain the leather. They are also expensive and often hard to obtain.

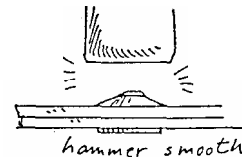
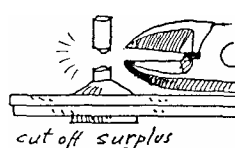

#### BIFURCATED RIVETS.

We seldom use these in our saddlery business, they break, twist, pull out and rust.



**SPEEDY RIVETS.** These are cheap, strong and easy to fit. However we find that in our humid climate they eventually rust and finally rot out.

## Simple Pouch

This simple pouch will fit any size pocket knife and is easy to make. However most bushmen prefer a pouch made specially to fit a particular knife.

They claim, quite correctly, that if the press stud comes loose it is very easy to lose a knife from this type of pouch.

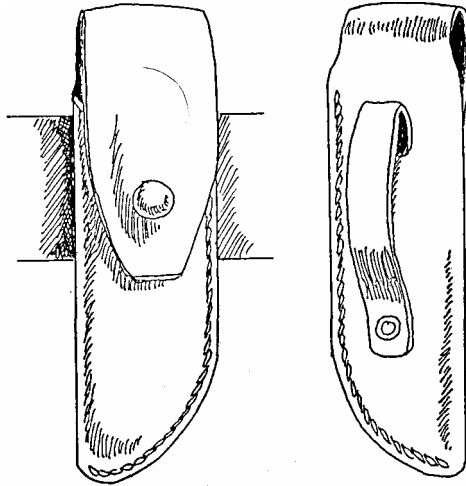

## Double Pouch

Noted horseman Brian Taylor once pointed out to me that when in the saddle all day a knife pouch worn on the front becomes twisted at an angle.

Some stockmen solve this problem by setting the pouches at an angle when making them.

In this case a double knife pouch has been sewn onto a piece of heavier leather, and this has been folded over and riveted to make a loop for the belt.

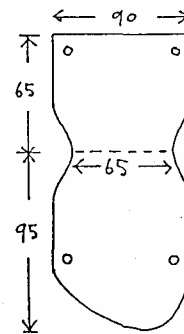
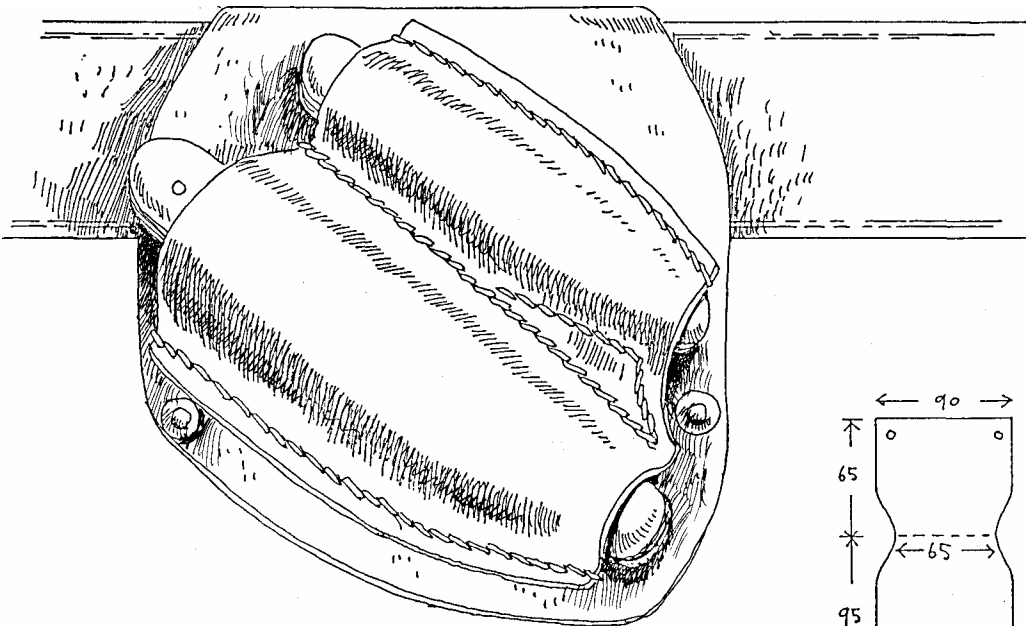
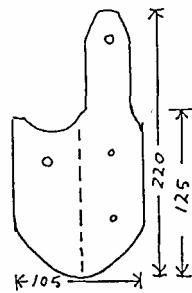



## *Rabbiters' Pouch*

Rabbiters, and other people who skin a lot of animals, need to keep their knives very sharp, and this sheath carries a separate pocket for a steel.

Note the copper (not steel) rivets at the top of the sheath. The soft copper will not harm the edge of the knife, but will prevent it cutting into the leather of the welt, and also prevent the stitching pulling apart at this point of strain.

Sheaths should always be made with a welt. This is a strip of leather which goes between the two main pieces.

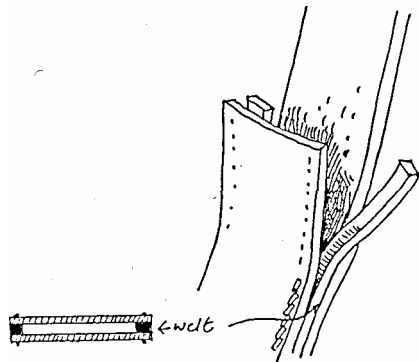

The stitching passes through it, and in this way the edge of the knife will not cut the stitching.

Sheaths should also have a small strap around the handle to prevent the knife accidentally slipping out.

## *Sailor's Knife*

In the old days of the sailing ships sailors used to have very deep sheaths, because a dropped knife could easily be lost overboard.

This one also had a cord with a toggle attached to the sheath to prevent it getting lost. When working in the rigging the knife could be fastened to the wrist by means of the toggle and the loop in the cord.

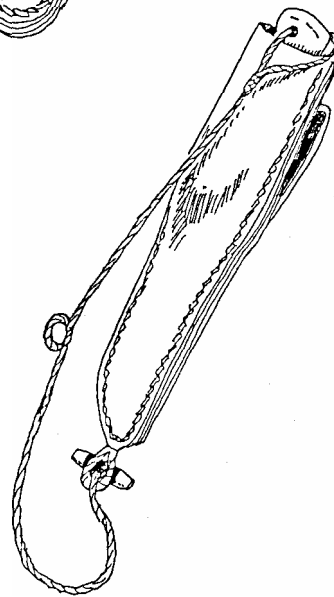
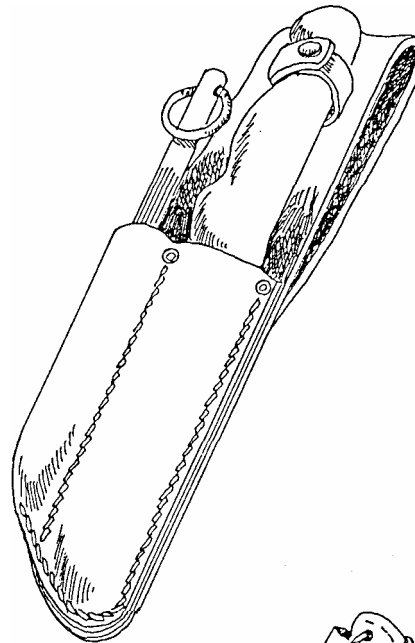

( By an odd coincidence while I was preparing this section a young RAN rating came into our saddlery business and asked me to make him a sheath, having just bst his knife, marlin spike and sheath overboard. No matter how deep the sheath, if your belt breaks you still lose the lot!)

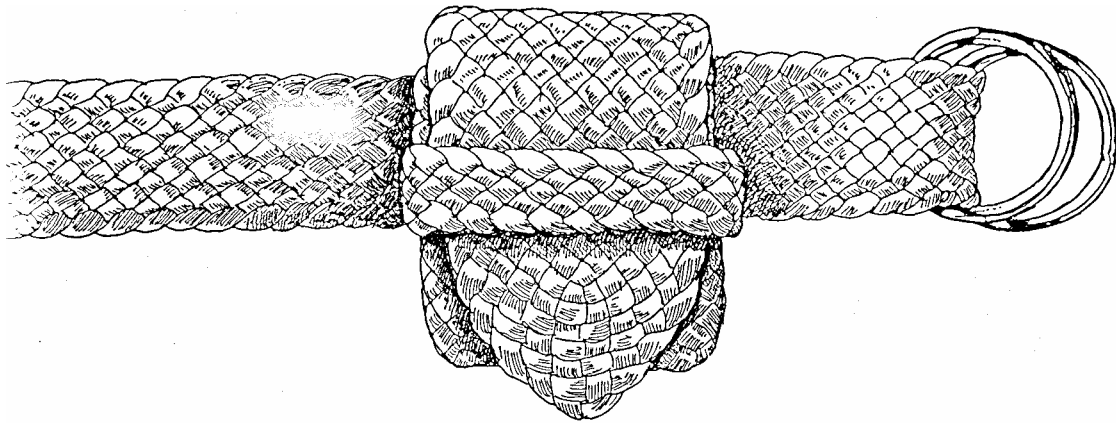

## Plaited Pouch

This simple looking pouch is the most complicated of all, and is capable of turning the calmest of plaiters into a twitching wreck.

Although the finished pouch will only measure about 60mm wide by 70mm deep it will take at least one full day to plait, and may even take more!

Don't attempt this one unless you can already plait belts.

The pouch is made in three parts, the pouch section, the flap (which also forms the wide keeper for the belt), and the small keeper.

The pouch section is formed with a Turk's-head. This has to be formed around a cylinder which is called a mandrel.

This can be made from a bush stick. If it is not the exact size it can be built up by wrapping a strip of leather or paper around it.

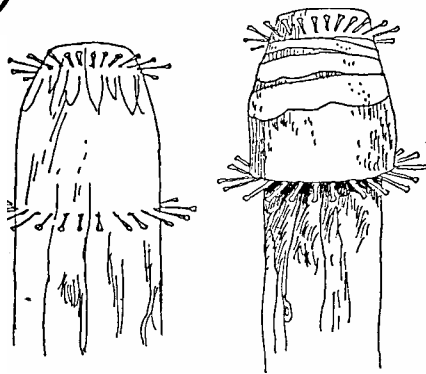

The working surface of the stick is 50mm long. It has a circumference of 140mm at one end and 130mm at the other.

18 small tacks are hammered around one end of the working part, and another 18 at the other end.

It is best to make the working surface as smooth as possible, this can be done by wrapping a couple of layers of sticky tape around it.

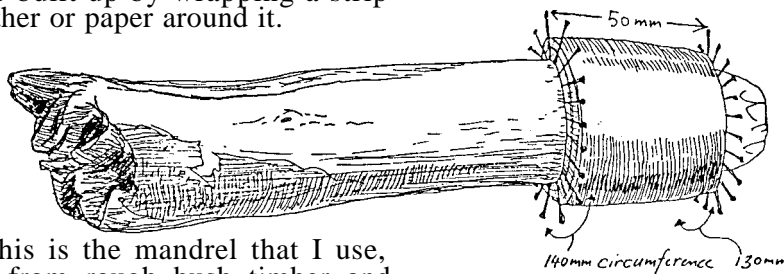

This is the mandrel that I use, made from rough bush timber and leather. One end is left longer and is used as a handle.

## THE POUCH SECTION

Before starting carefully check the lace to see that it has no weak spots or joins. As the work progresses it becomes tighter, and the best of splices tend to snag and pull apart.

The sketch shows numbers all around the mandrel, but there is no need to do this. Just mark number one and number 10.

Fig. 5. A simple loop will hold the lace in place. Go from number 1 to number 10.

Fig. 6. Around number 2 and up to number 11.

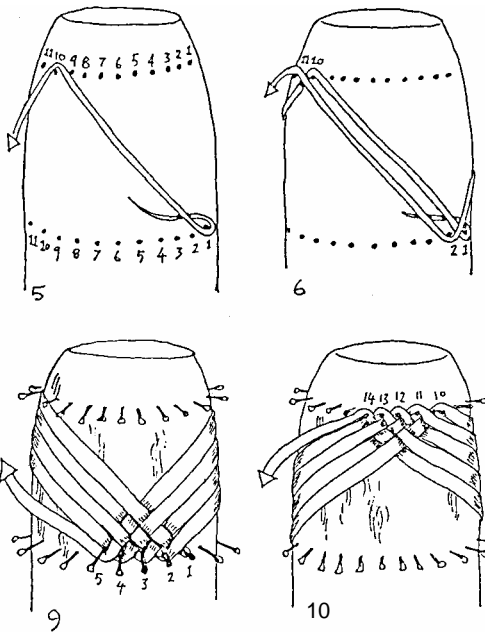
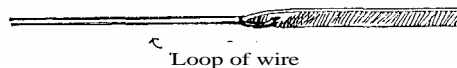

Fig. 9. This is how the lace should really look. From 5 it goes to 14. Fig. 10. From 14 it goes down to 6 and so on.

A lacing needle is really needed for this sort of work. If one cannot be obtained a rough one can be improvised with fine wire.



## AMOUNT OF LACE NEEDED.

Strands of 4.5mm (3/16") kangaroo hide lace are used for the pouch.

Depending on the tanning and the thickness of the hide some lace stretches more than others, and so exact measurements for plaiting can never be given.

The measurements given here are what I used for the pouch shown in the drawings.

POUCH SECTION. 3200mm (10'6"). Best allow another 600mm to be on the safe side.

FLAP. Cut 8 lengths, each 800mm.

SMALL KEEPER. Cut 3 lengths each 550mm.

TOTAL LENGTH. 11.25metres (37')

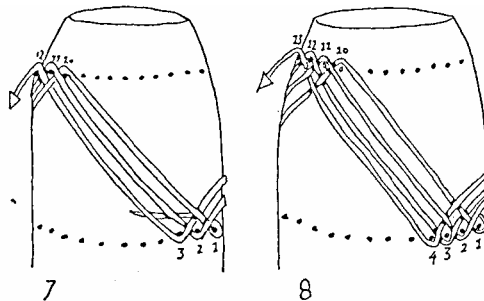
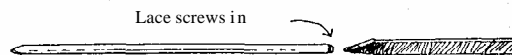

Fig. 7. The plaiting now begins to follow an under - one-over - one sequence.

Fig. 8. The work continues in this manner. NOTE. For the sake of clarity the lace has been shown very thin, but in practice each strand must just touch the previous strand.



The best needle is called a Life-eye needle. It has a threaded end, and the lace screws into it.

Another trick is to harden the point of the lace with super-glue.

A lacing fid is also needed to open up tight places, otherwise the needle will keep pulling out of the leather.

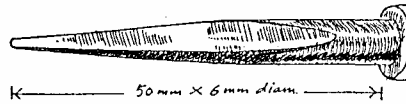
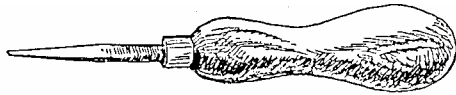

Proper fids can be bought, but they are easy to make from a scrap of steel rod. I made mine from a bone.

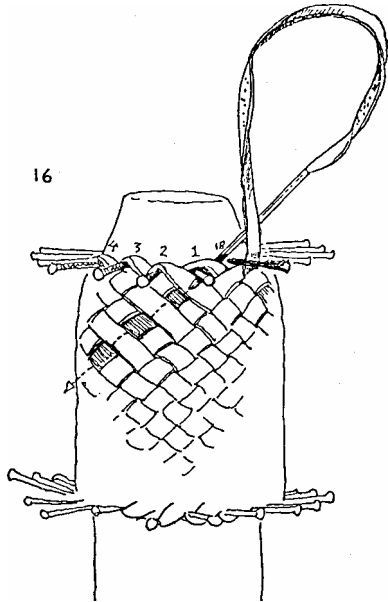

Fig. 16. As the work progresses it gets slower and slower. In time, and if all your calculations are correct, you will come around once more to number 1 and find a gap of only the thickness of a strand of lace.

Take the lace under the loop of number 1 and work down as shown.

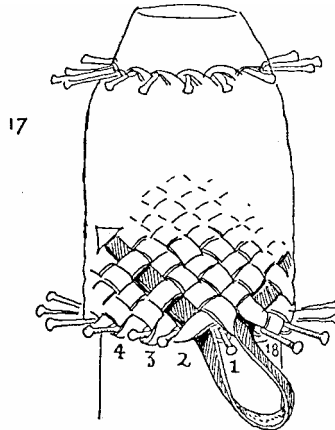
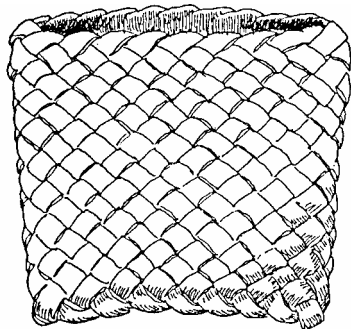

Fig. 17. The mandrel will now be fully plaited over. To finish off take the end of the lace up on top of the strand that started the job, the one that went from number 1 to number 10.

Work up as least as far as shown, pull tight and cut off flush. The pouch section is now complete.



Remove all the tacks and slide the plaited work off the mandrel. It should look like fig. 18.

**PROBLEMS.** Because of variations in the thickness and stretch of the lace it may be that the plaiting becomes either too tight or too loose. It is possible to see this happening quite early in the plaiting, and steps must then be taken to correct it.

If the plaiting is going to be too loose then add in 2 more tacks both top and bottom. If it is becoming too cramped for space then remove 2 tacks top and bottom.

Either way this will mean repositioning most of the other tacks, though it is often possible to do this without having to undo what work has already been plaited, if you get in early enough.

### THE SMALL KEEPER

The pouch section is by far the slowest part of the job, the rest is as shown

Take 3 lengths of lace, each 550mm long and place them in fig. 19.

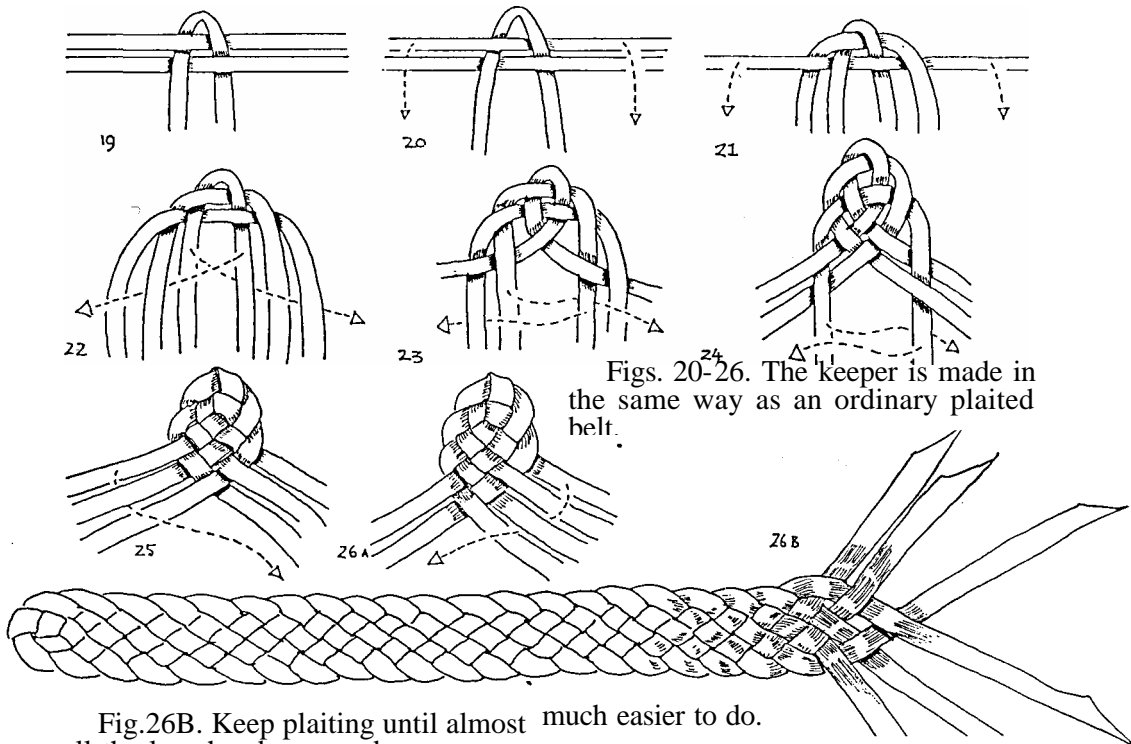

Figs. 20-26. The keeper is made in the same way as an ordinary plaited belt.

Fig.26B. Keep plaiting until almost all the lace has been used up. much easier to do.

Fig.27. Form the strap into a loop that will fit snugly around the pouch.

Plait the 3 ends marked \* into the start of the strap as shown.

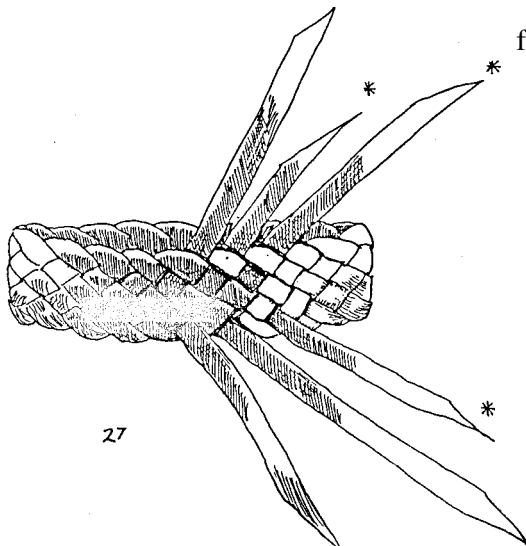
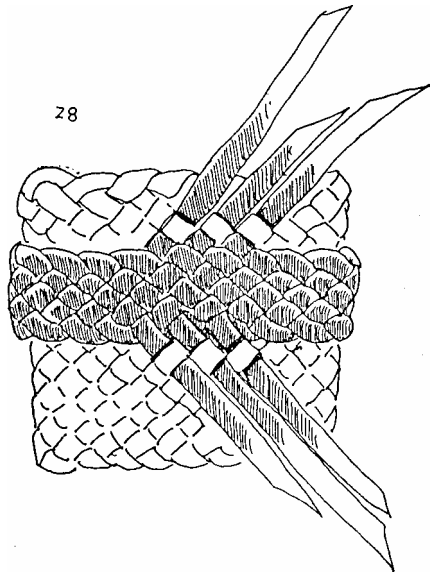

Fig.28. Slip the small keeper over the pouch section, and on the back of the pouch plait the ends in as shown.

Continue this plaiting until all the ends go under 2 loops of the pouch and then cut the ends off flush.

The small keeper will now be firmly attached to the pouch section.

28



**THE FLAP**

Cut 8 lengths of lace, each 800mm long and arrange them as shown in fig.29.

The point is formed in the same way as was shown for the small keeper, except that more strands are

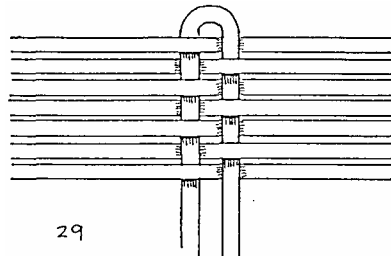
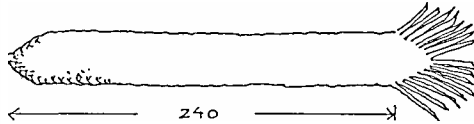
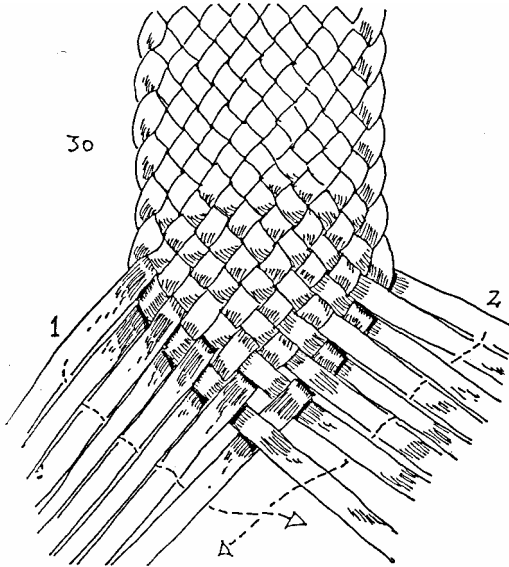

Fig. 30. When the point has been formed plaiting continues in the sequence shown.



Plaiting continues until almost all the lace has been used up, the plaited section should be about 240mm long.



Feed the flap through the pouch section so that it comes out through the hole in the bottom and lays at the back as shown.

Fig.33. The ends are now plaited into the beginning of the same strap.

Use a lacing fid to open up the previously plaited strands so that the ends can be fed through.

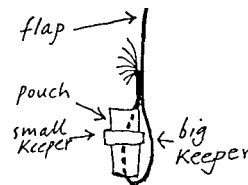
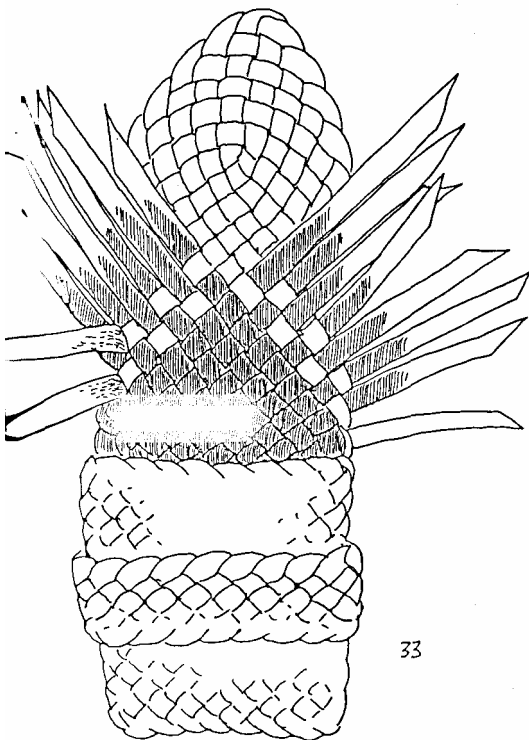

Fig.35. A side view before the ends are trimmed flush.

involved.

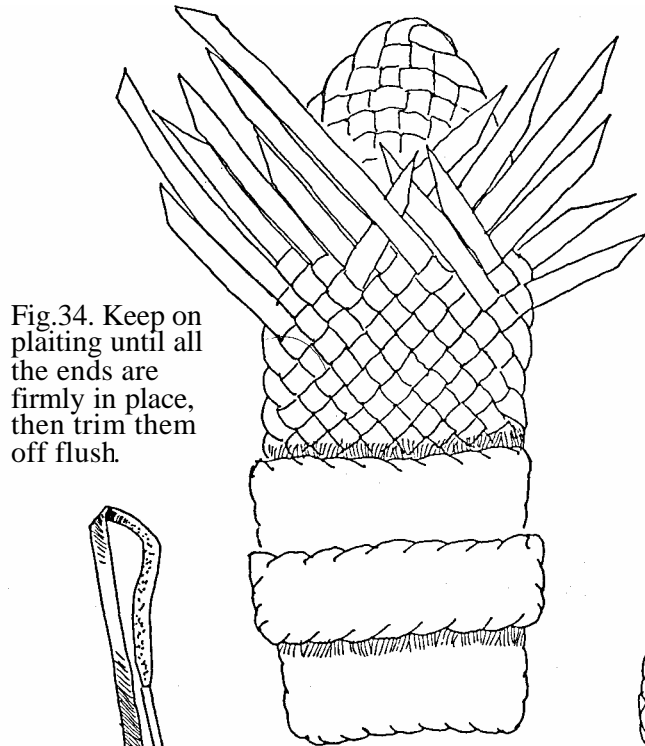
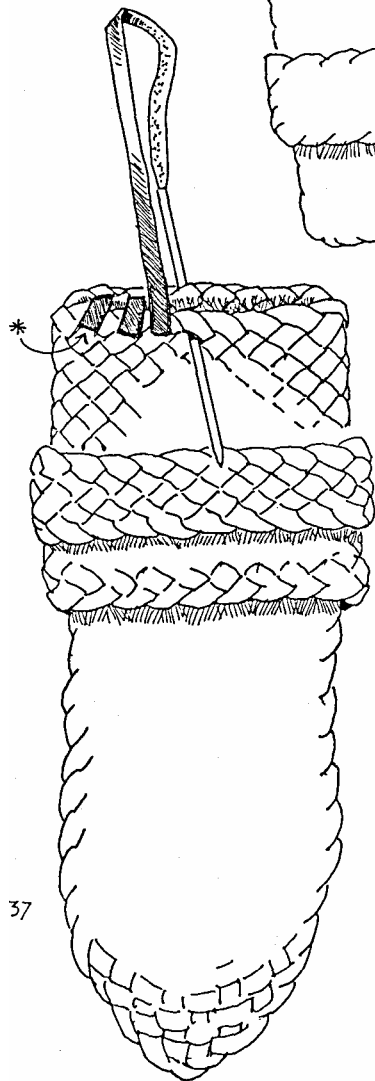
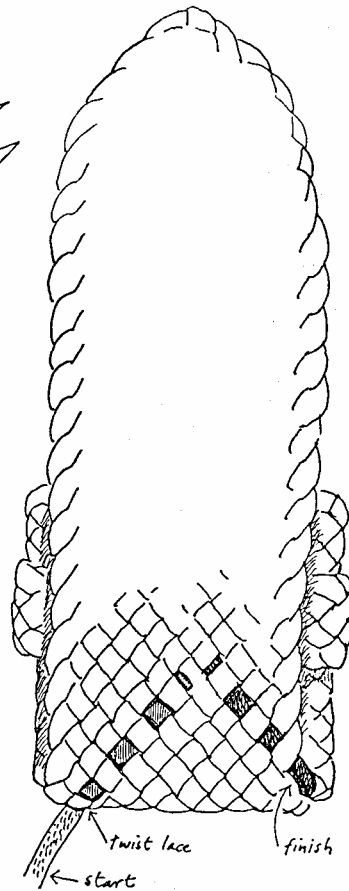

Fig.34. Keep on plaiting until all the ends are firmly in place, then trim them off flush.



37



36

Fig.36. The last job is to stitch up the bottom of the pouch. This view is of the back of the pouch and shows how the lace is plaited in at the start and finish of this job.

The lace has to be reversed at the start, and this twist should be done at the point shown, so that it is hidden under a strand.

Fig.37. The lace comes through at the point marked \*. Try and make the stitches as neat as possible, so that they match the rest of the plaiting.

Finish as shown in fig. 36.

The pouch is now ready to be slipped onto the belt.



pouch round in the back. The sides are of 4mm leather and the rest of 3mm leather. It fastens with a pouch stud.

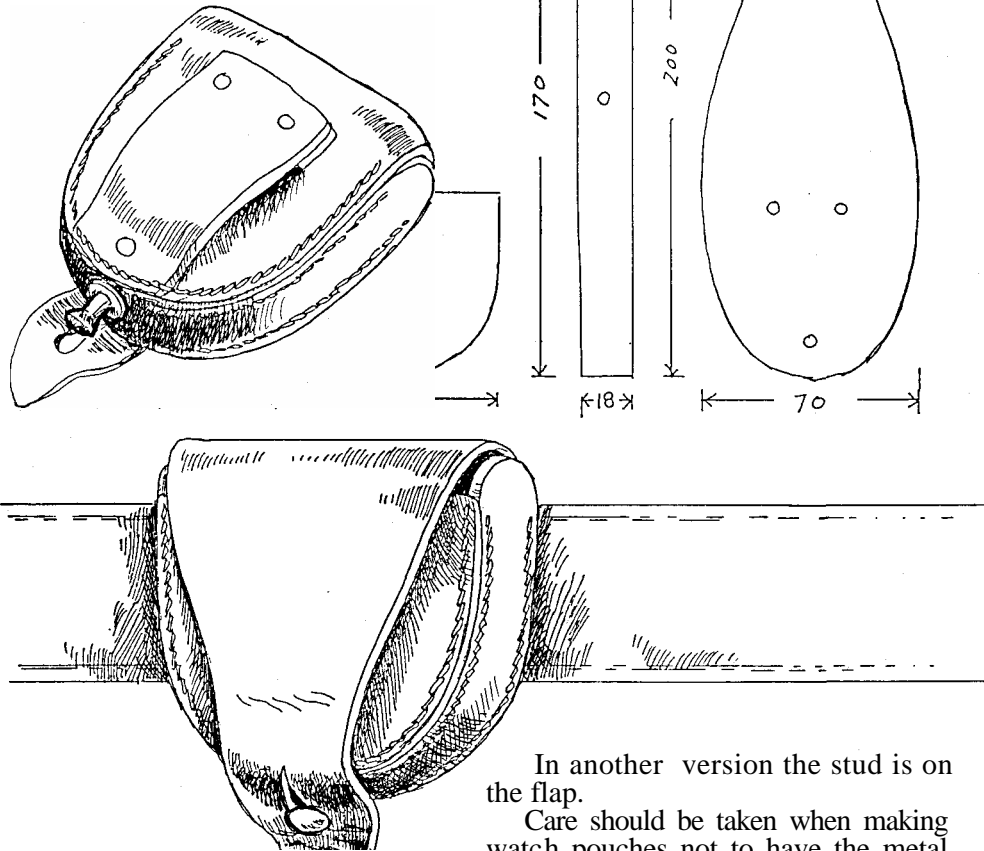

In another version the stud is on the flap.

Care should be taken when making watch pouches not to have the metal parts of the studs exposed on the inside where they will rub against the watch. Thin leather or cloth should be glued in to cover any metal.

Some leatherworking skill is required to make this type of pouch, as the stitching goes through at an angle.

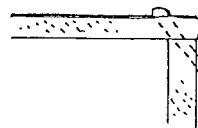

# Drop-down Pouch

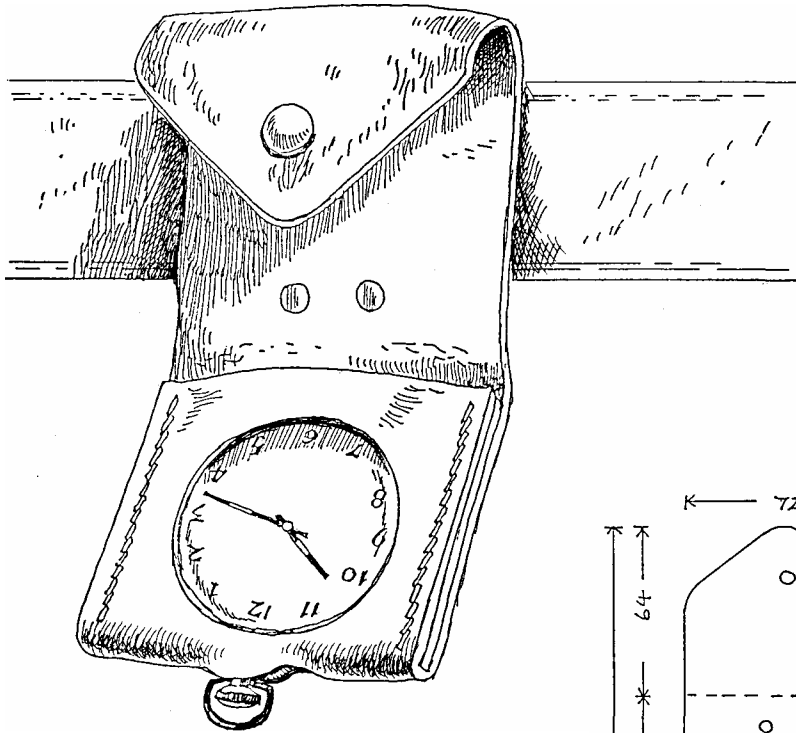

An easier pouch to make, and one that is in many ways better, is the drop-down pouch. The great advantage of this design is that the watch does not have to be handled, it can even be wound while still in the pouch.

The pouch is fastened with a press stud or a pouch stud, and when undone the watch drops down to where it can be read.

This pouch has a small welt on each side. The pouch should be a snug fit for the watch so that it cannot move about.

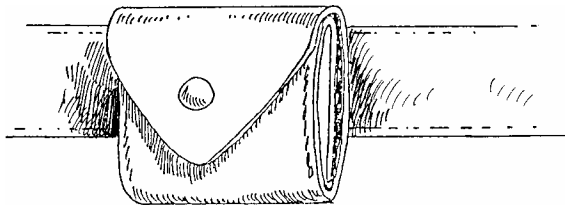
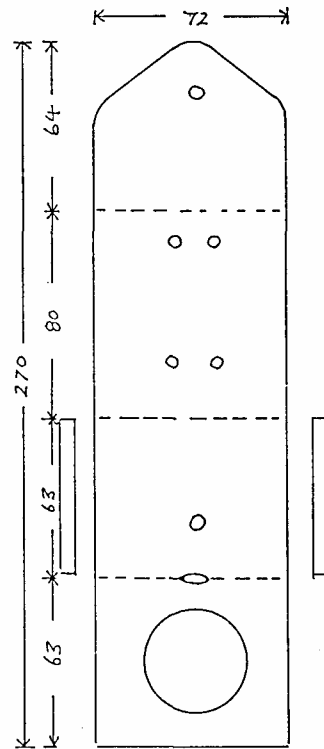

# LEATHER LACING

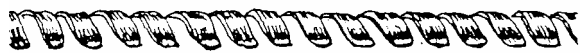

WHIP STITCH



WIDE WHIP



MUMMY WRAPPING



BACK WHIP



CROSS STITCH

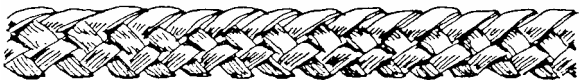

ROUND BRAID



SINGLE CORDOVER



DOUBLE CORDOVER



TRIPLE CORDOVER



LAZY S



DOT STITCH



BAGGIN'S STITCH

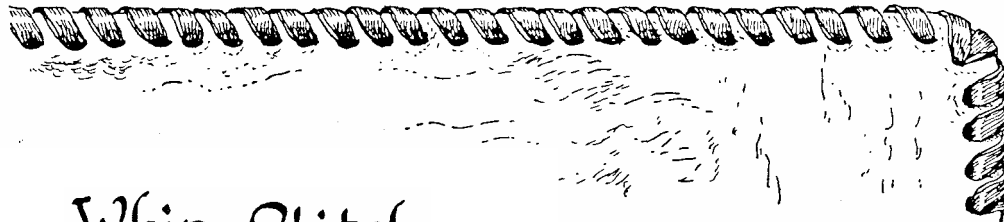

# Whip Stitch

The whip stitch is the most simple stitch of all, and the one most often used for fastening two pieces of leather together.

The only problem likely to be encountered in doing this stitch is in making a neat start and finish. **AMOUNT OF LACE NEEDED.** Four times the length to be covered.

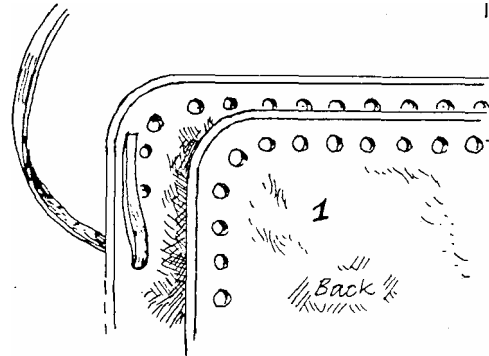

Fig. 1. This shows the job from the back. Put one end of the lace through the bottom hole in the front piece of leather.

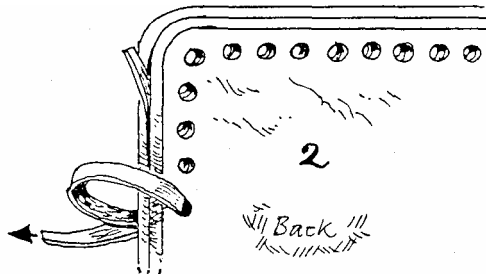

Fig. 2. Now bring the two pieces of leather together and begin lacing.

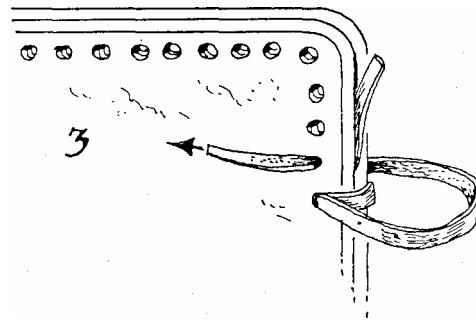

Fig. 3. This shows the job from the front. The start of the lace will be hidden from view between the two

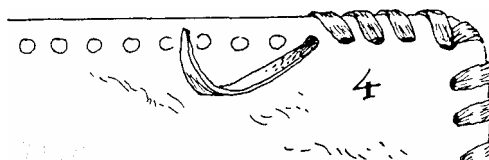

Fig. 4 When going around a corner take the lace through the corner hole twice. This looks better and makes for a stronger corner.

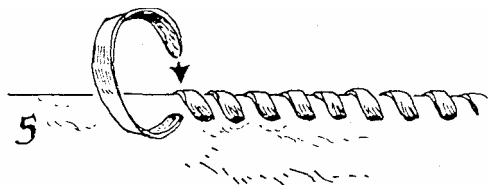
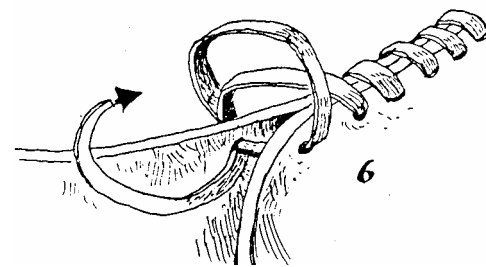

Fig. 5. FINISHING OFF. Take the end over and go through the last hole in the back piece of leather again.



pieces of leather.

Fig. 6. Bring the end out between the two pieces of leather.

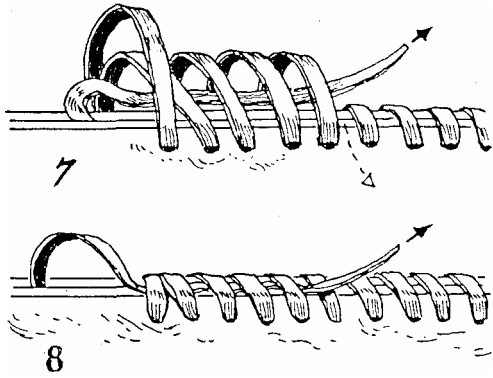

Fig. 7. Take the end back though a few loops. It can either remain in sight as shown, or you can follow the dotted line and push it down inside the job between the two pieces of leather.

Fig.8. Tighten up the lacing and then pull the end tight. If you have pushed the end between the two pieces of leather then pull it tight from the inside.

Fig.9. Trim the end off neatly.



Fig. 10. WHEN THE LACE BREAKS. When you run out of lace before the job is completed this method is used so that the join will not be visible.

The end is brought up between the two pieces of leather and taken back under a few loops.

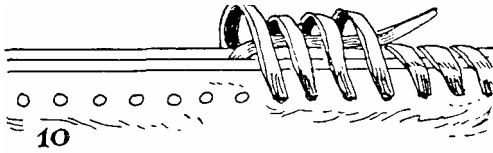

Fig. 11. The loops are tightened and the end pulled firm. It can be trimmed flush or pushed down between the two pieces of leather.

The new piece of leather has its end concealed between the two pieces of leather in the same way, and then lacing continues.

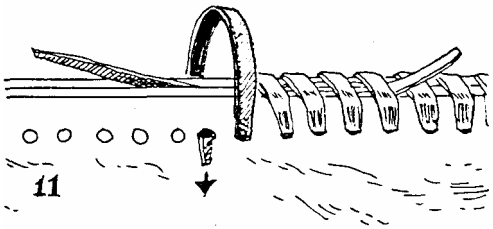
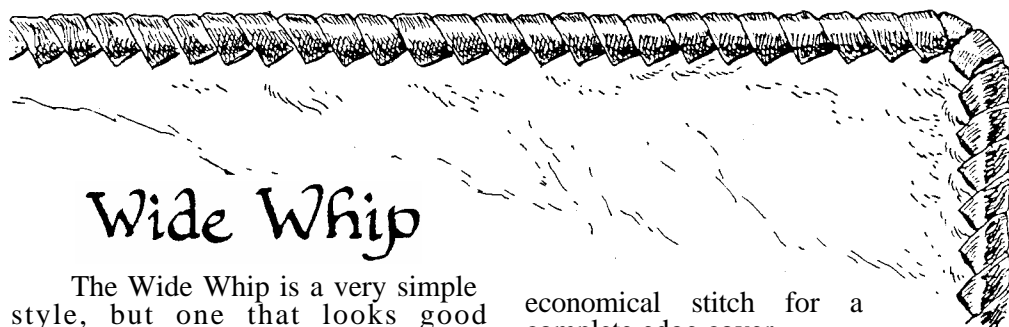
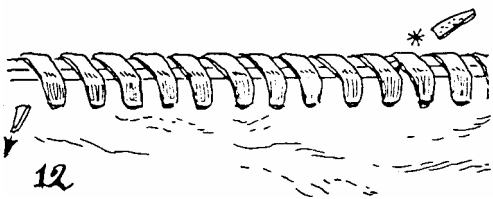

Fig. 12. If this is done neatly there will be no sign of where the old lace finishes and the new lace begins.



## Wide Whip

The Wide Whip is a very simple style, but one that looks good because it covers the whole edge of the leather. It is also the most

economical stitch for a complete edge cover.

For the best effect all the holes should be made with a slit punch, and put in at an angle as shown.

A slit punch can be made by flattening and sharpening a nail as mentioned on the front inside cover.

**AMOUNT OF LACE NEEDED.**  
Around five times the length to be covered.

The distance between the holes is calculated according to the width of the lace being used. Remember that when lace is being pulled tight it tends to become a little narrower, so allow for this when marking out.

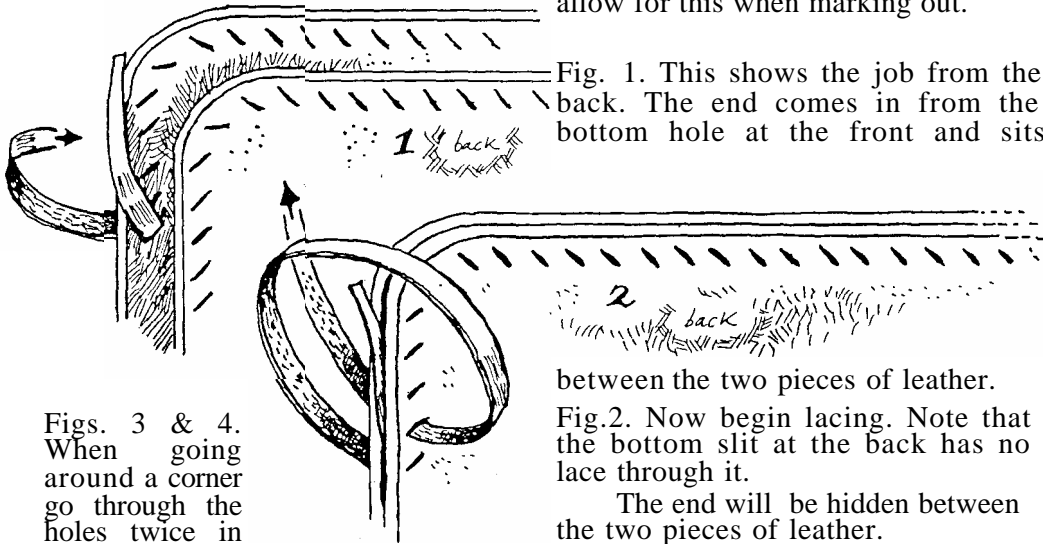

Fig. 1. This shows the job from the back. The end comes in from the bottom hole at the front and sits

Figs. 3 & 4. When going around a corner go through the holes twice in order to get a good cover over the leather.

between the two pieces of leather.

Fig. 2. Now begin lacing. Note that the bottom slit at the back has no lace through it.

The end will be hidden between the two pieces of leather.

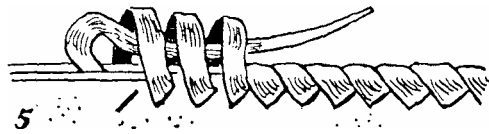

Fig. 5. This is how to finish off if you have run out of lace. The end comes up between the two pieces of leather and is taken back under a few loops. The lace is then pulled up tight.

The end can be trimmed off flush or is pushed down between the two pieces of leather out of sight.

This is also the way to finish when you have gone right around a job and come to the beginning again. You will find that you now fill the hole that was left empty in Fig. 1.

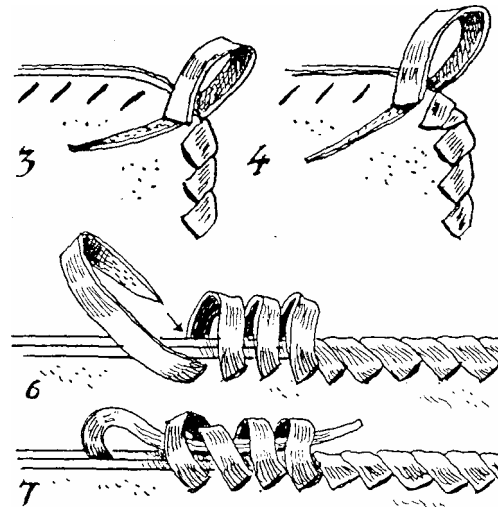

Fig. 6. This is the way to finish when you wish to fill all the holes. The lace is taken through the final hole twice at the back.

Fig. 7. Now bring it up between the layers of leather and take it back under a few loops.

Tighten up the lace and cut the end off flush.



# Mummy Wrapping

This stitch gets its name from a fancied resemblance to the wrappings of Egyptian mummies.

It is a useful stitch for change purses as it completely closes up the seam so that small coins cannot slip out.

Wide lace is used and goes through each hole twice.

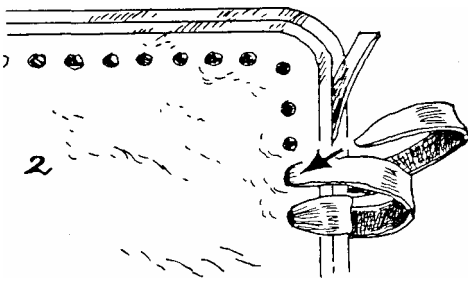

Fig. 2. The lace now goes through each hole twice. It may help to use the lacing fid to clear the hole each time.

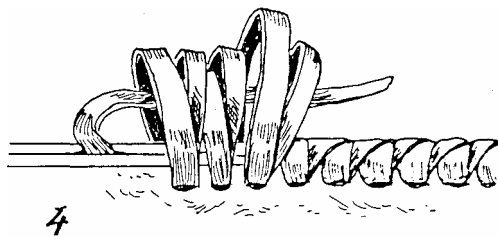

Fig. 4. When finishing up take the lace through the last hole at the back and then bring it up between the two pieces of leather.

The last few stitches are loosened and the end goes through them.

AMOUNT OF LACE NEEDED. 8 times the length to be covered (on small jobs allow 10 times so as to have enough spare when finishing up.)

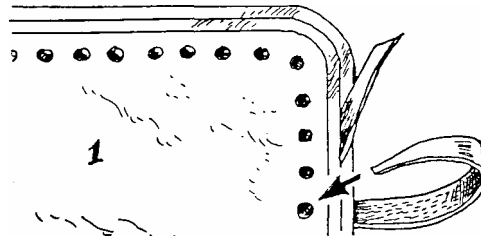

Fig. 1. The lace goes through the bottom hole at the back, and the end sits between the two pieces of leather.

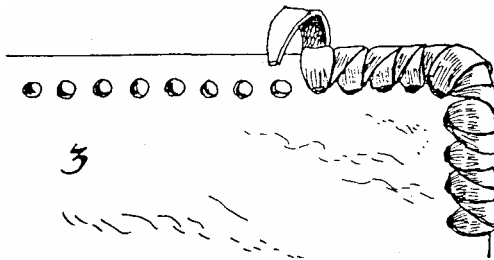

Fig. 3. When going around corners take the lace through 3 times.

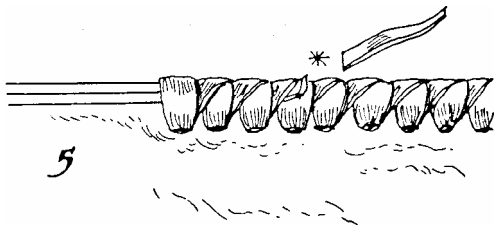

Fig. 5. Tighten up the last stitches, pull the end firm and then trim it flush.



# Back Whip

This is not a particularly attractive stitch, but it is a quick way to get a strong edge on a job.

**AMOUNT OF LACE NEEDED.** Nine times the length to be covered.

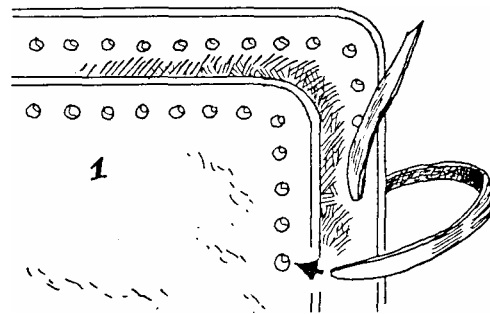
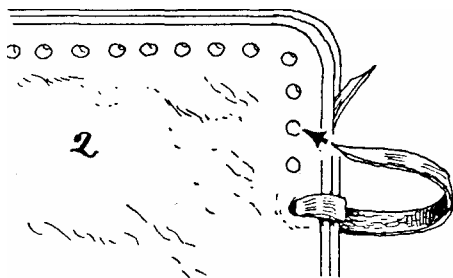

Fig. 1. The end is hidden between the two pieces of leather.

Fig. 2. Miss one hole and go in the next.

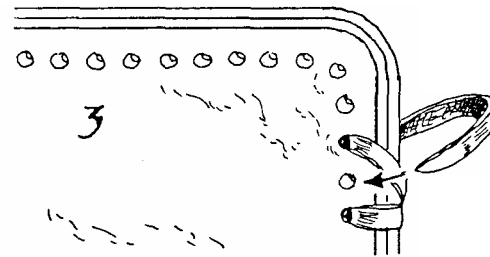

Fig. 3. Come back and go through the empty hole.

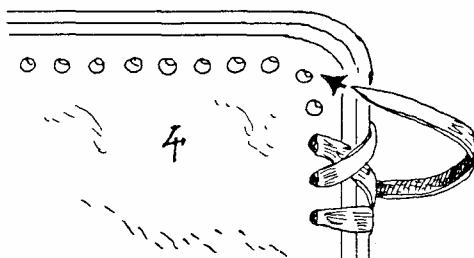

Fig. 4. Miss one hole and go in the next.

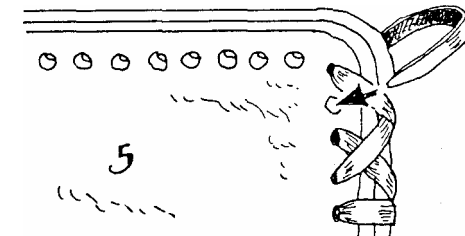
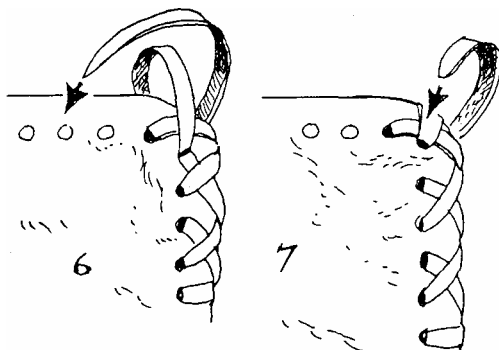

Fig. 5. Come back and go in the empty hole.



Figs. 6 & 7. One peculiarity about this stitch is that there are two ways of rounding a corner, depending on what part of the stitch is being done when the corner is reached.

In both cases the lace goes through one hole twice. The sketches show the two methods.





Fig. 8 When finishing go through the last hole twice at the front and bring the end up between the two pieces of leather.

Take it back through a few loops, then work the loops tight.

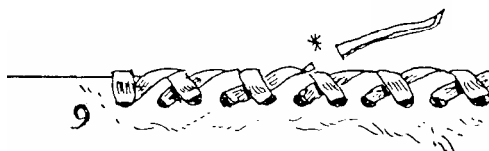

Fig.9. Pull the end firm and cut it off flush.



## Cross Stitch

A mildly decorative stitch with limited applications. To achieve the best effect the holes are spaced further apart than normal, and also brought in further from the edge.

For this reason this stitch can be used with very soft leathers that tend to tear easily, such as the belly parts of basil.

However it is not suitable for very thin skins.

AMOUNT OF LACE NEEDED. 5 or 6 times the length to be covered.

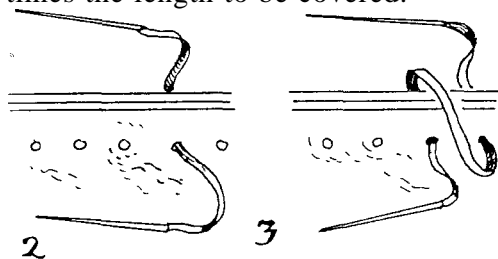

Fig.2. Have half the lace on either side of the job.

Fig. 3. Bring one end through.

Fig. 4. The needle will pull away from the lace if any pressure is applied.

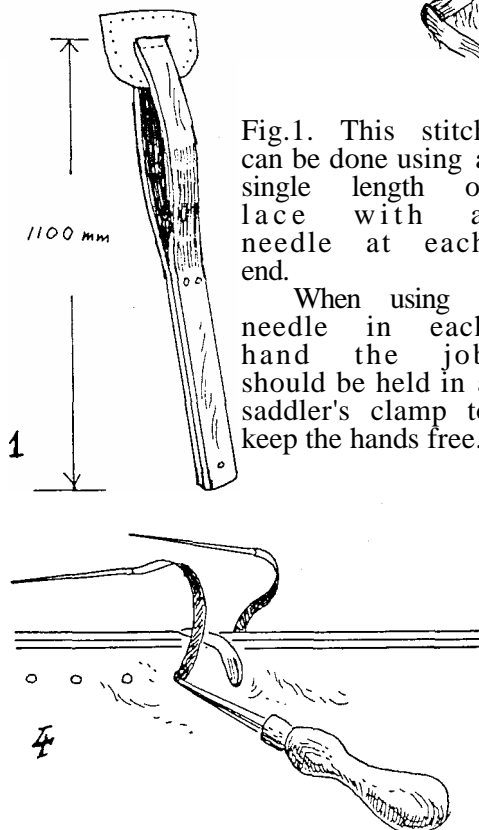

Fig.1. This stitch can be done using a single length of lace with a needle at each end.

When using a needle in each hand the job should be held in a saddler's clamp to keep the hands free.

To avoid this use the lacing fid to open up the hole before putting the needle through.

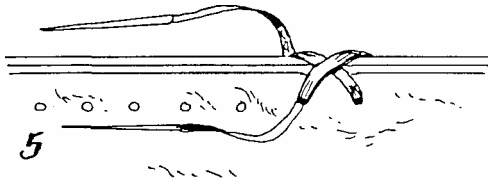

Fig. 5. Stitching continues in this manner.

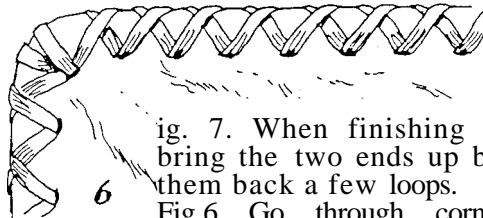
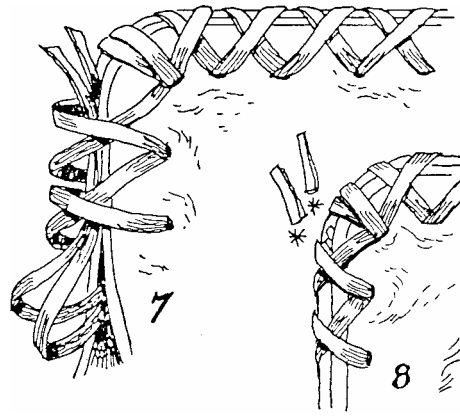
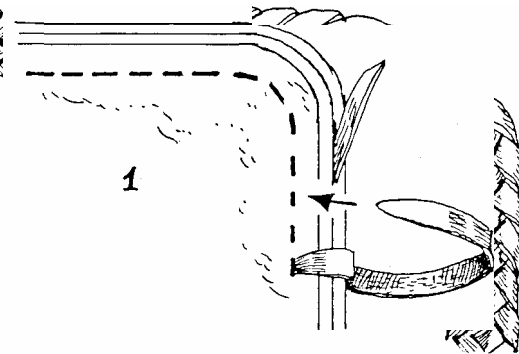

Fig. 6 Go through corner holes a couple of extra times for added strength.

Fig. 7. When finishing up bring the two ends up between the layers of leather and take them back a few loops.

Fig. 8. Tighten the loops, pull the ends firm and cut them off flush.

## Round Braid



This is an attractive braid, easy to remember and simple to do. It is very strong and completely covers the edge of the job.

The finished job looks better if the holes are punched with a slit punch rather than with a hole punch, but either method can be used.

It is best to use a needle when doing this braid, especially if the holes have been made with a slit punch, though I have done it without when I have mislaid the needle, using a lacing fid or similar small tool to open up the holes.

AMOUNT OF LACE NEEDED. 9 times the length to be covered.

Fig. 1 Begin as for the previous methods, concealing the end between the two pieces of leather.

Lace to the end of the job leaving each second hole empty.

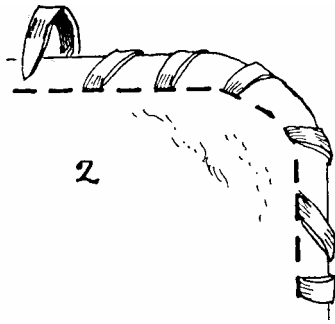

Fig. 2. Round the corners off as much as possible, and in this way you will get a better cover than with a sharp corner.

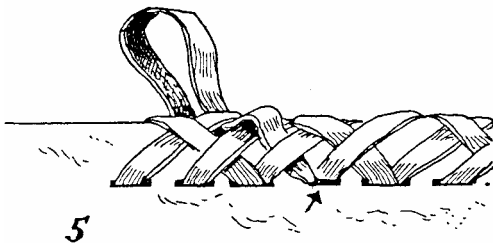

Fig. 5. Having reached the end begin the final return. This part of the job takes time as the lace must be taken under one strand, over one and under one before going into the hole.

It is best to use a lacing fid or similar tool to open the lace a little before you bring the end through.

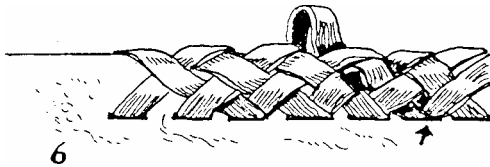

Fig. 6. Again showing how the lace is brought back.

Fig. 7. This shows the job from the back when the stitching has been completed.

Fig. 8. Feed the end through under the stitching and bring it out a little further back along the job.

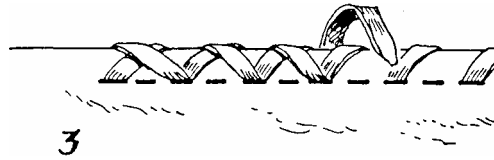

Fig.3. When the end of the job is reached come back to the beginning, going through the same holes.

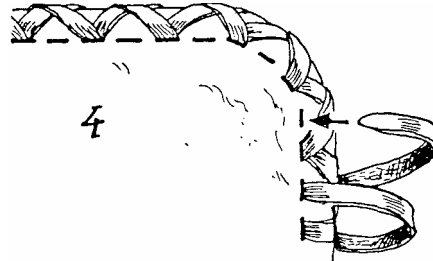

Fig. 4. Having reached the beginning set off again, this time going into the empty holes.

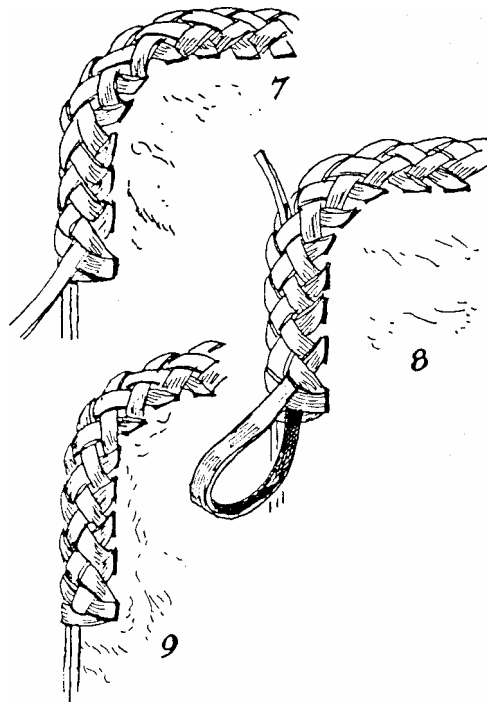
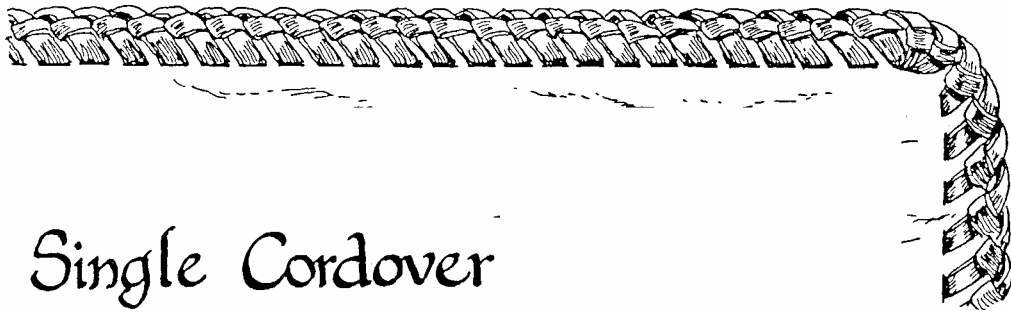

Fig 9. Pull the end up tight and trim it off flush.



# Single Cordover

This is a popular and ancient stitch which may have originated in the Spanish province now known as Cordoba.

Cordoba was once famous for its leather work, and the stitch is also known as Spanish Edging.

It is not as complicated as it may look at first, but it is a slow stitch to work.

This is the most simple form of the stitch.

AMOUNT OF LACE NEEDED. 6 or 7 times the length to be covered.

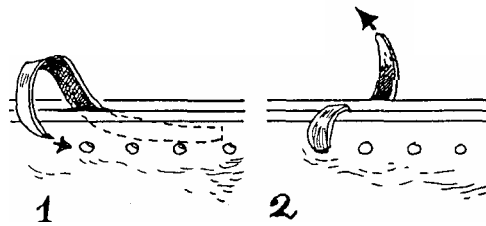

Figs 1 & 2. Begin with the end tucked between the two layers of leather. Take the lace through the first hole.

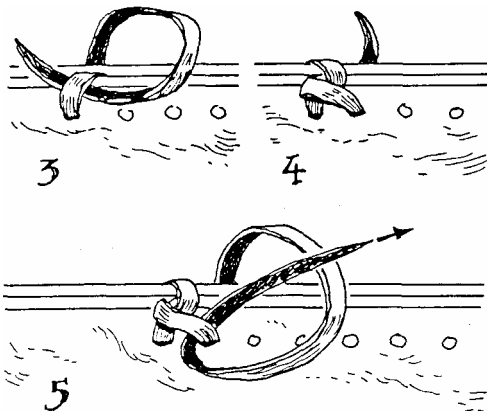

Fig. 3. Pass the lace under the first strand. It is best to use a lacing needle for this stitch. Fig. 4. Go into the second hole.

Fig. 5. Bring the end through as shown. Make sure that the loop is formed as illustrated.

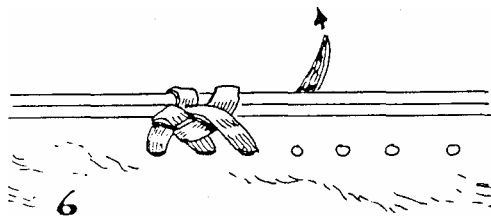
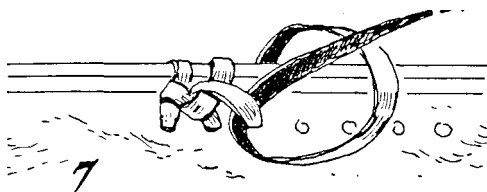
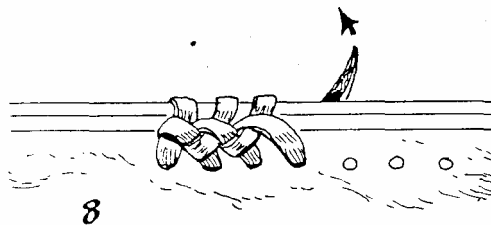

Fig. 6. Take the lace through the third hole.



Figs 7 & 8. Stitching continues in this manner.



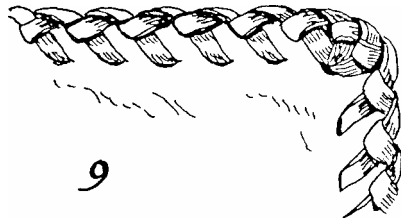
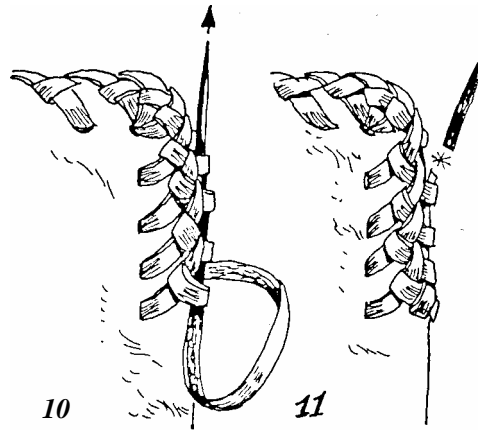

Fig. 9. When going round a corner go through the same hole 2 or 3 times to get a good cover. Remember that corners get the most wear.

Figs 10 & 11. To finish take the end back under a few strands. Pull firm and cut off flush.



Once begun this is as simple to do as the single loop Cordover, and though it takes a little longer to do it covers the edge more efficiently and so looks much better.

By the same token the triple loop Cordover covers a wider edge than the double loop, so the best plan is to use the single loop stitch when dealing with thin leather, the double for medium and the triple for thick leather.

For a very neat job use a slit punch to make the holes, for a quicker lacing job use a hole punch.

A needle on the lace makes the job much easier.

AMOUNT OF LACE NEEDED. 7 to 8 times the length to be covered.

Fig 3. Go back under one strand of lace.

Fig. 4. Go into the third hole.

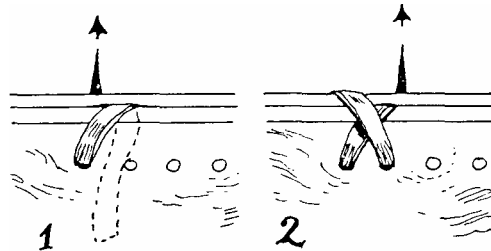
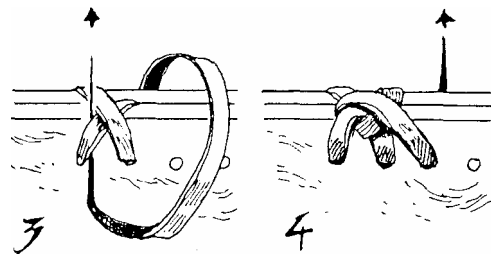

Fig. 1. Hide the end between the layers of leather.

Fig. 2. Go through the second hole.



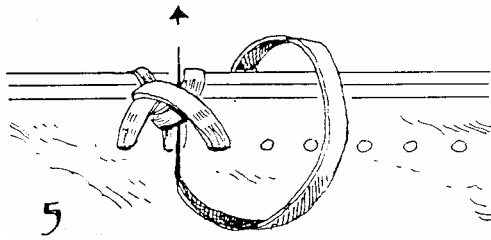

Fig. 5. For the rest of the sequence you take the end under two strands of lace each time.

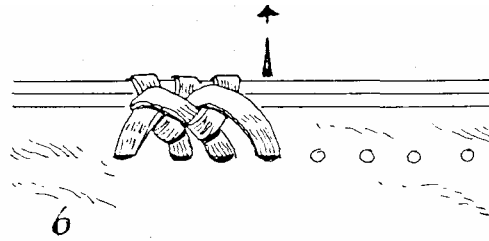

Fig.6. Go into the fourth hole.

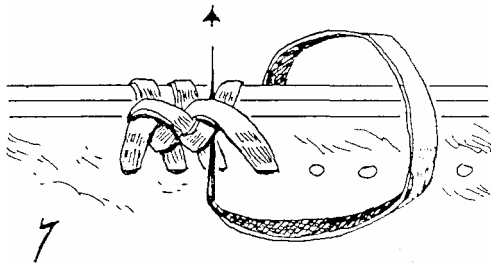

Fig. 7. Back under two strands.

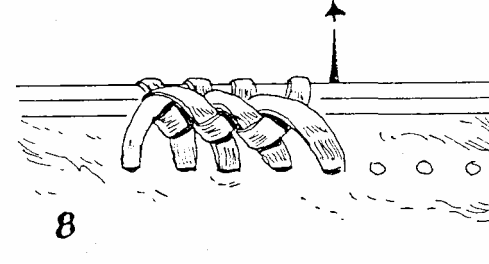

Fig.8. Into the fifth hole and so on.

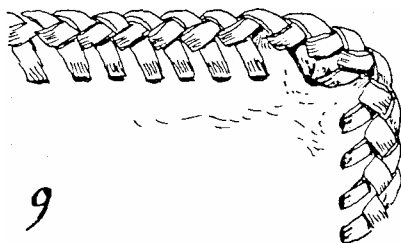
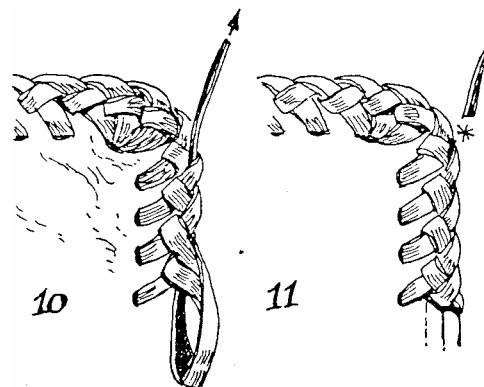

Fig.9. To get a well covered corner go through the corner hole three times.



Figs 10 & 11. To finish take the end back under a few strands. Pull up firm and cut off flush.



single



double



triple

Although all the cordover stitches may look somewhat similar from the side the difference can be easily seen when they are looked at from the edge.

I prepared these three samples using the same thickness of leather for each and the same width of lace.

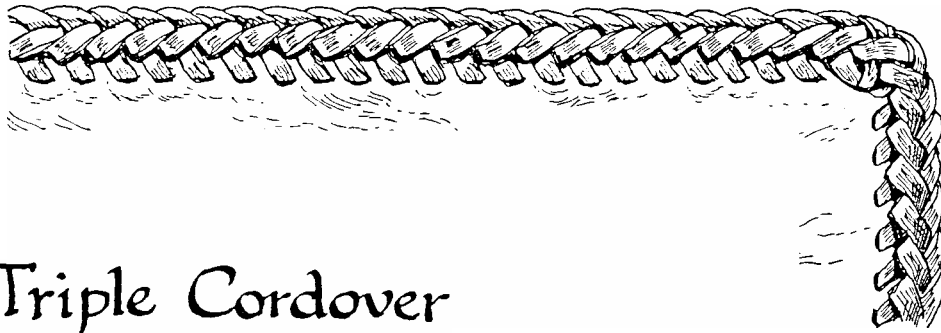

# Triple Cordover

All the cordover stitches follow the same basic pattern, the only difference is the number of layers under which they are passed before going on to the next hole.

The triple cordover takes no longer to do than the double cordover. It uses a little more lace but covers a wider edge.

AMOUNT OF LACE NEEDED. 9 to 10 times the length to be covered.

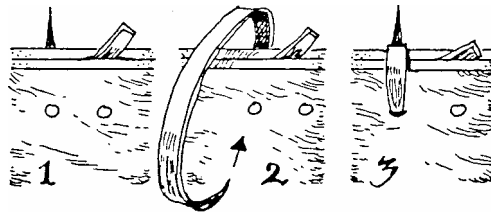

Fig. 1. Hide the end between the two layers of leather and come out through the first hole at the back.

Fig. 2. Go in the first hole at the front.

Fig. 3. Come out the back and pull

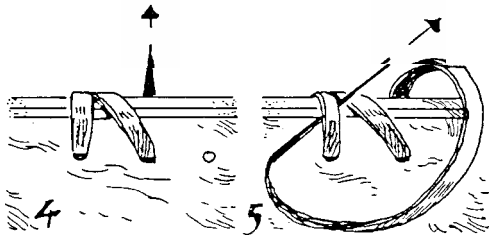
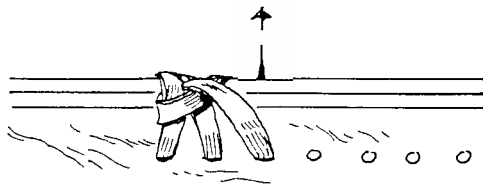

Fig. 4. Go in the second hole.

Fig. 5. Go under the first lace.



firm.

6

Fig. 6. Go into the third hole.

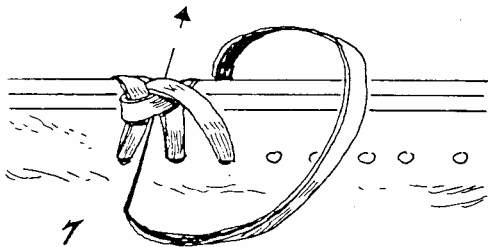

Fig. 7. Go under as shown.

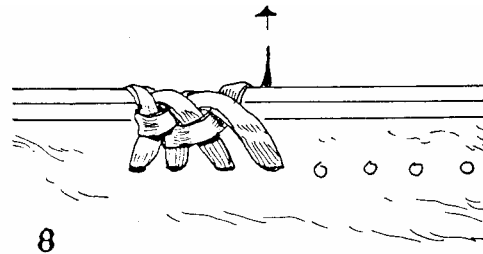

Fig. 8. Into the fourth hole.

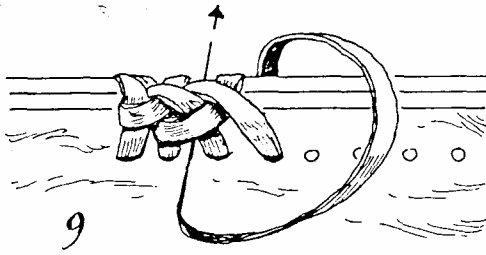

Fig. 9. Go back two holes and under three layers of lace.

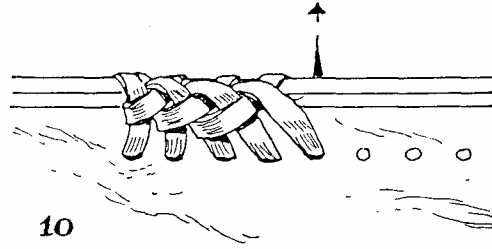
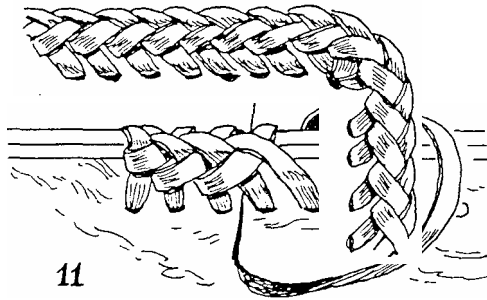
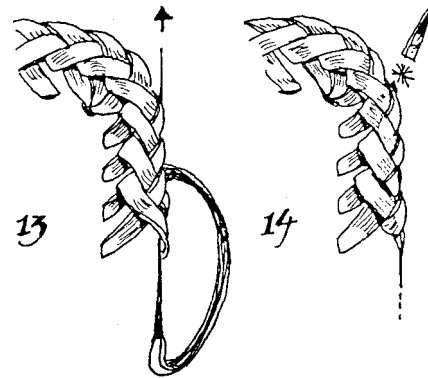

Fig. 10. Into the fifth hole.

Fig. 11. Go back two holes and under three layers of lace. Continue in this manner.



11



13

14

12

Fig. 12. Go through the corner hole

Fig. 13. Finishing off. Go back under a few loops. three times to get a good coverage.

Fig. 14. Pull tight and cut off flush.

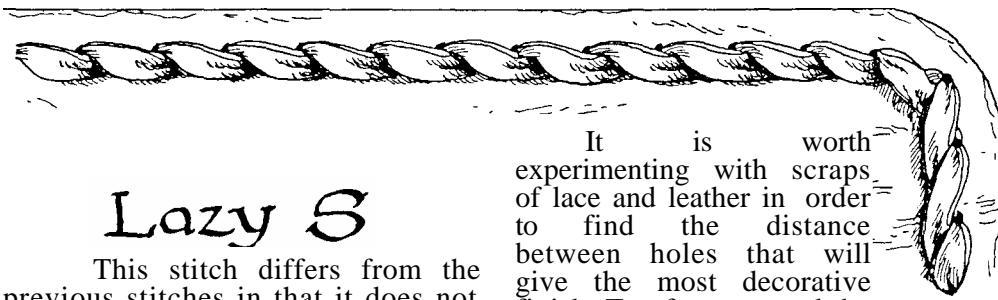

## Lazy S

This stitch differs from the previous stitches in that it does not go over the edge of the leather.

For this reason it is used for such jobs as sewing pockets on the outside of handbags, or dividing a knife pouch into two parts to make a place for a sharpening steel.

It is worth experimenting with scraps of lace and leather in order to find the distance between holes that will give the most decorative finish. Too far apart and the stitch will look weak, too close together and you will lose the "S" effect.



AMOUNT OF LACE NEEDED. 5 times the length to be covered, but as always this will vary according to the thickness of lace and leather.

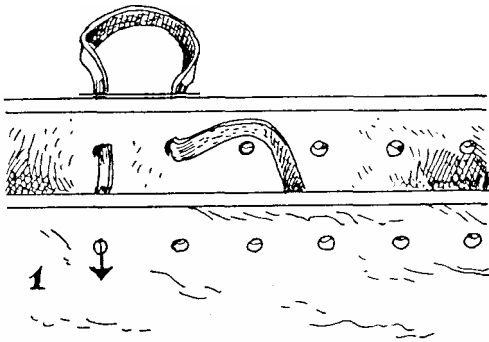

Fig. 1. Conceal the end between the two layers of leather. Bend it as shown so that it will be gripped when the leather is sewn together.

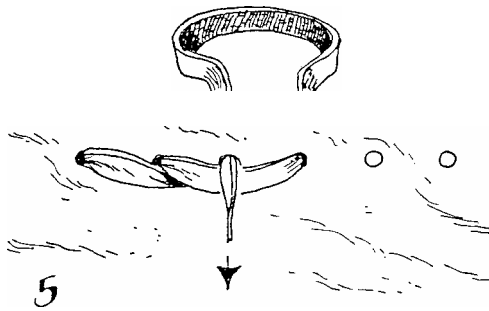

Fig. 5. Return through the third hole. The sequence continues in this way, going forward two holes and returning one.

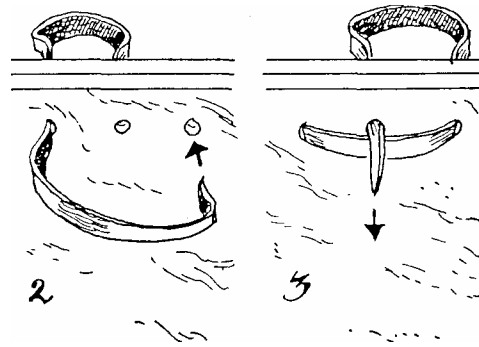
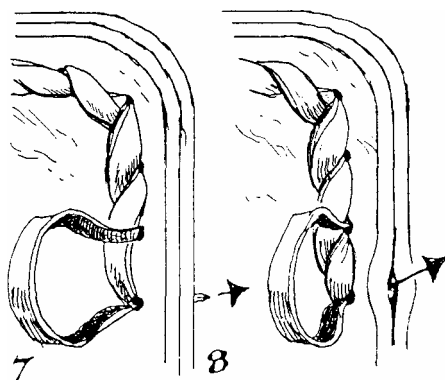

Fig. 2 Come out the first hole and go in the third.

Fig. 3. Return through the second hole.

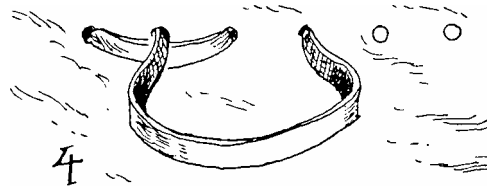

Fig. 4. Go in the fourth hole.

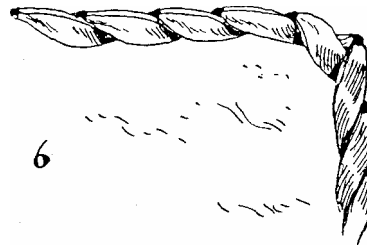

Fig. 6. Corners do not present any problems when doing this stitch.

Fig. 7. Finishing off. Move forward only one hole.

Fig. 8. Repeat the stitch but this time come out between the two layers of leather. This should make the lacing firm.

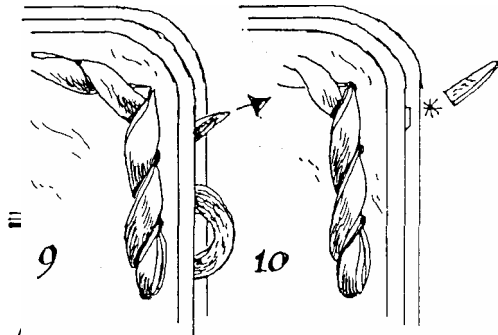
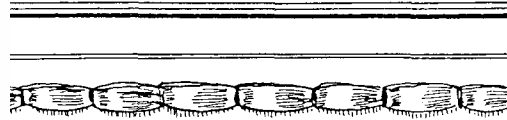

Fig. 9. Go down inside the job, around some lace and come out again.

Fig. 10. Cut off flush.



is desired.

## Dot Stitch

same way.

This stitch is much more regular in appearance than the Lazy S, and the Lazy S stitch, and so is done in the same way. It can be used on tool holders and the

It is actually the r

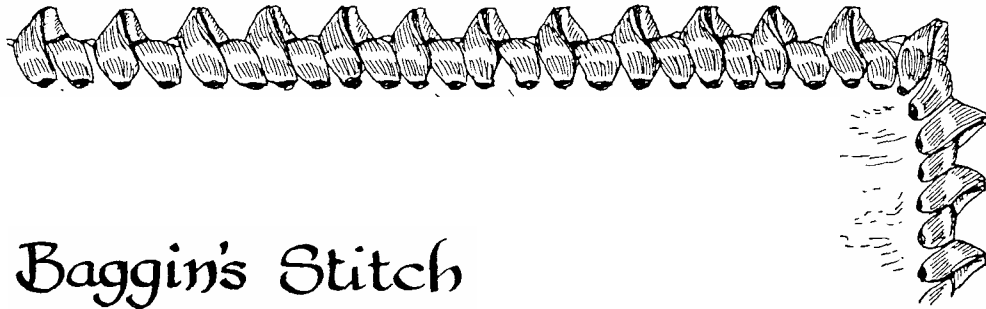

## Baggin's Stitch

This is a stitch that I invented some years ago, and which I named after my granddaughter. It is a purely decorative stitch, and takes about as long to do as the Cordover stitch.

AMOUNT OF LACE NEEDED.  
times the length to be covered.

Fig. 1. The holes should be placed just double the width of the lace

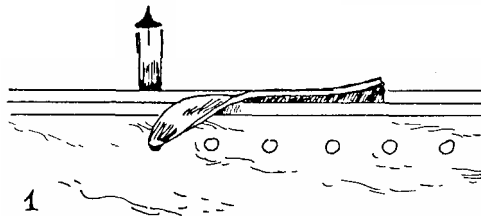

apart. In this way a good cover is obtained.

Go through the first hole and then tuck the end out of sight between the two layers of leather.

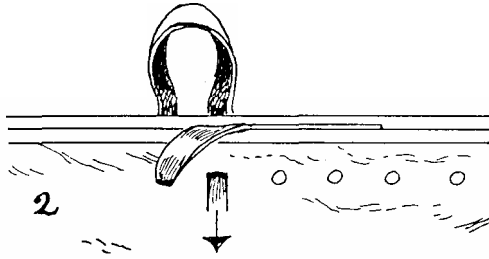

Fig. 2. Come back through the second hole bending the lace as shown.

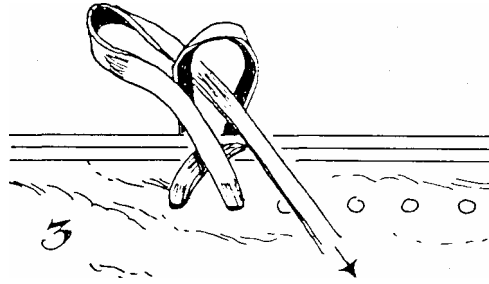

Fig. 3. Wrap the lace around and through the previous loop.

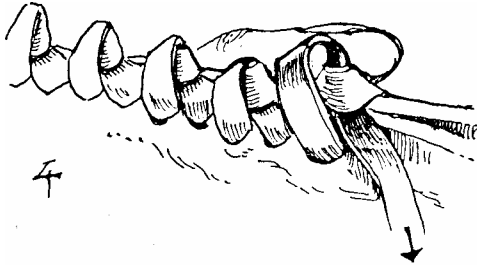

Fig. 4. Tighten up the lace gently. As you proceed you will find that the peaks can be formed best by using your finger from behind to push the back loop forward so that it sits right on the edge of the leather.

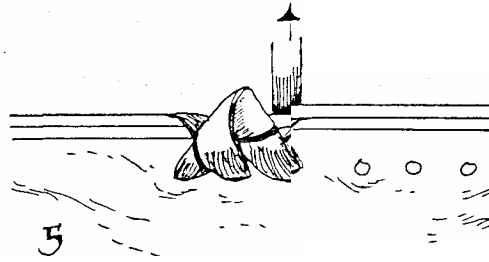

Fig. 5. Having formed the point take the lace through the third hole.

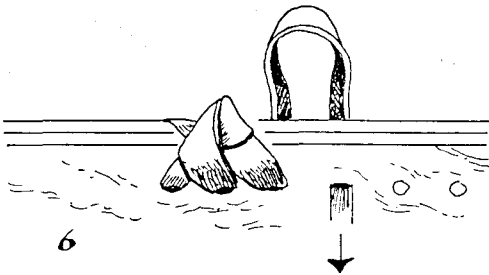

Fig. 6. Again form a loop behind.

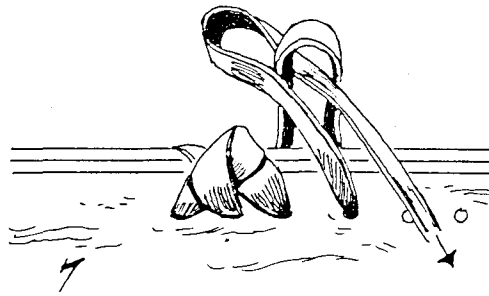

Fig. 7. Wrap the front lace around the back loop as shown.

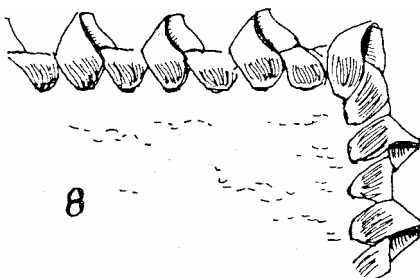

Fig. 8. Corners present no problems with this stitch.

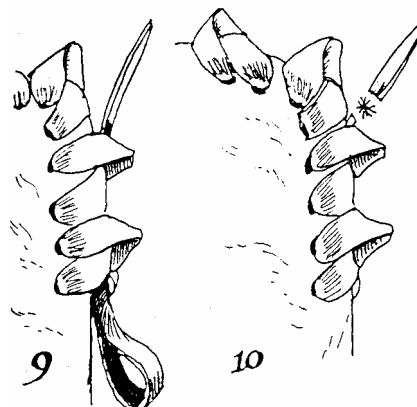

Fig. 9. Finishing off. Take the end back under a few stitches.

Fig. 10. Pull up firm and cut off flush.

6

# PLAITS

## ROUND & FLAT

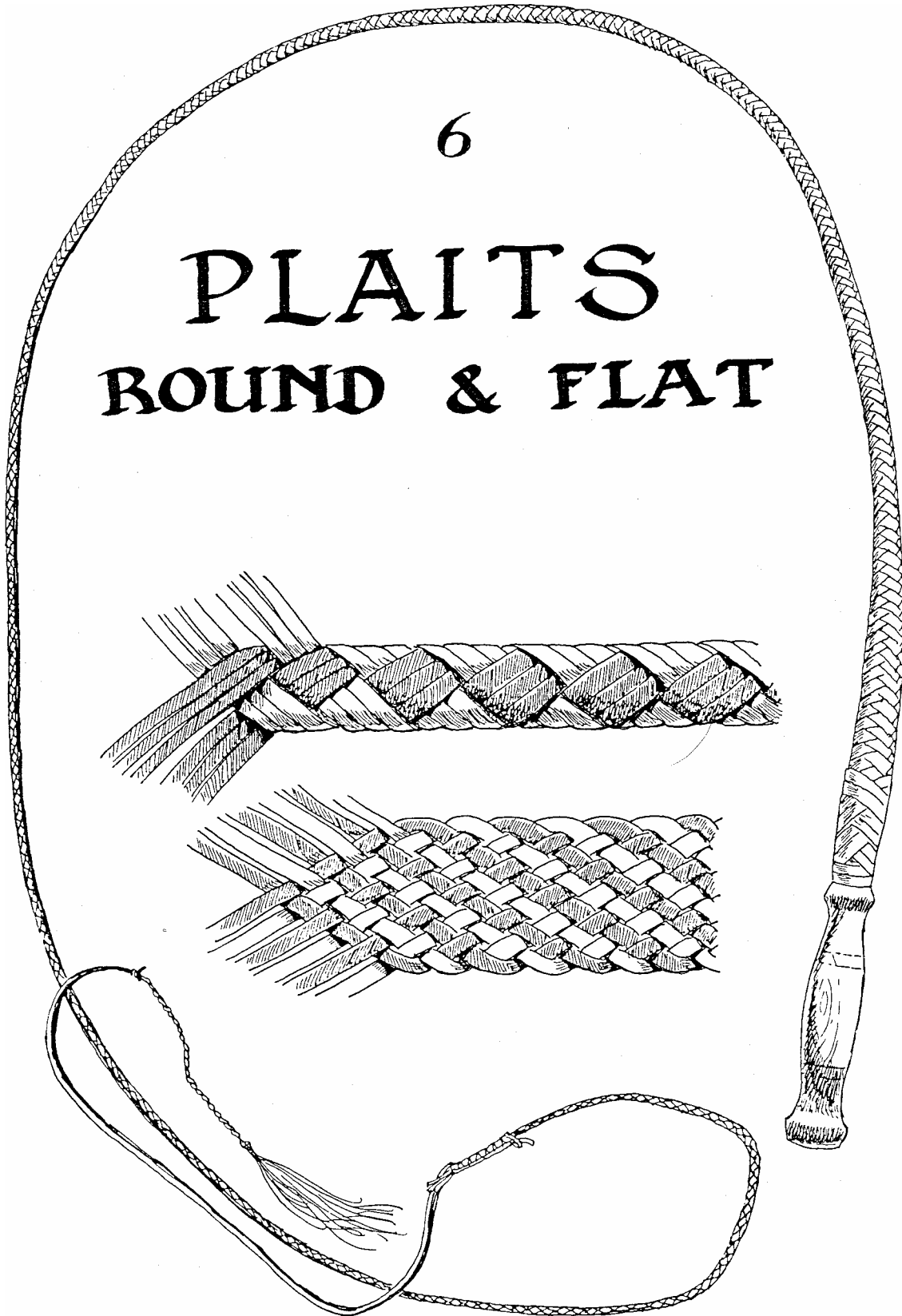

# Three Plait

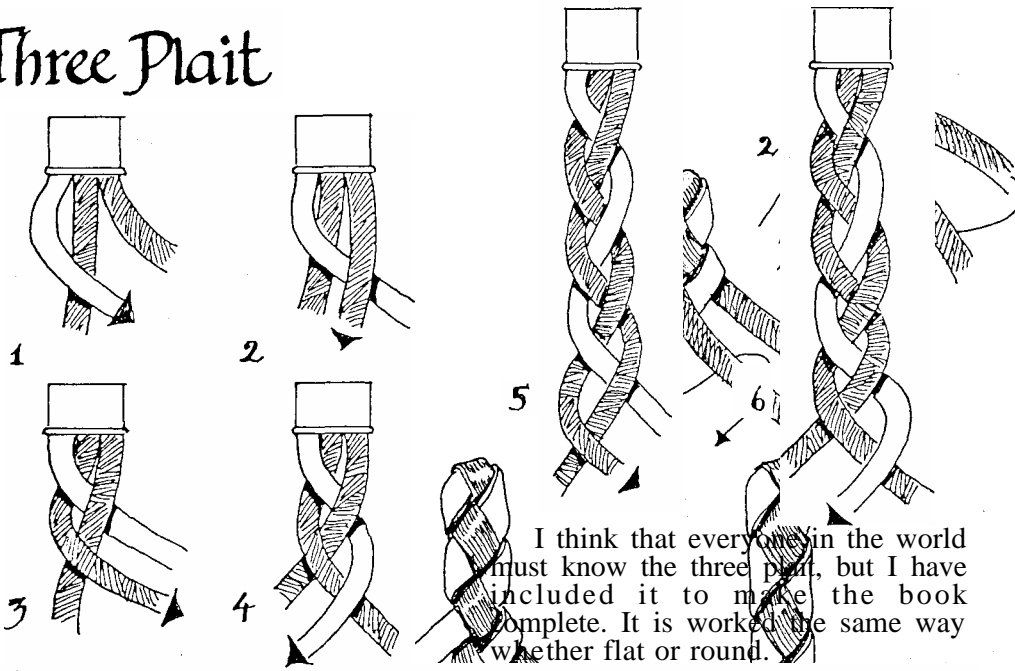

I think that everyone in the world must know the three plait, but I have included it to make the book complete. It is worked the same way whether flat or round.

# Four Plait (round)

The four plait is the most useful of all plaits, with it you can make a collar for a bandicoot or a rope thick enough to hold an ocean liner.

It is worked the same way whether you are using flat lace or

Fig. 2. Take the top right strand, bring it around the back and between the opposite pair. Continue this same sequence.

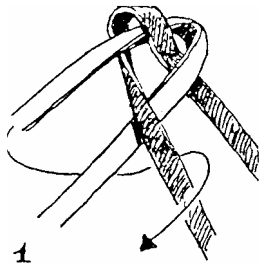
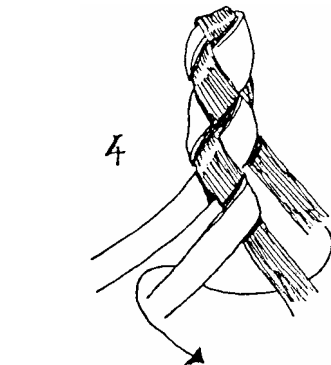

Fig. 1. To begin either tie four strands together or use two lengths and double them over as shown.

Take the top left strand around the back and bring it through the opposite pair.



cord.

# Crown Knot

## FINISHING THE ENDS

When plaiting is completed the ends can be whipped, as described elsewhere, or they can be finished with a decorative crown knot. The crown knot is not limited to use with only a four plait, it can be used for other plaits as well.

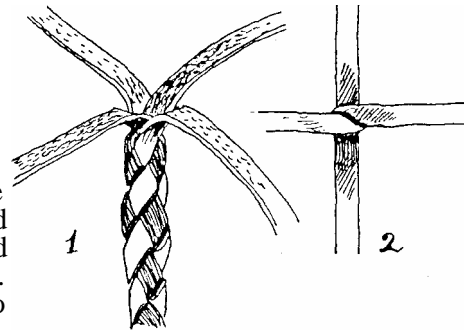

Fig. 1. When plaiting has been completed hold the end up like this

so that the rough side of the lace is showing.

Fig. 2. This is how it looks above.

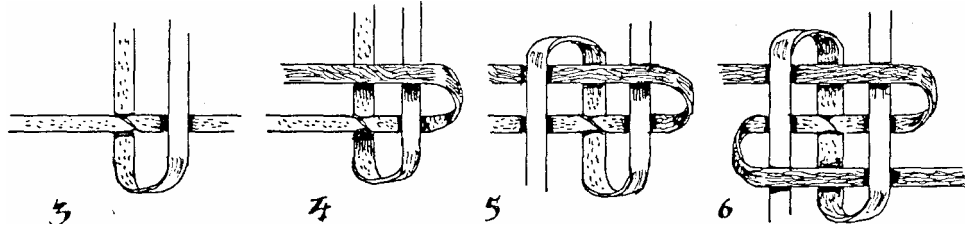

Fig. 3. Now begin bending each strand tucked over the one next to it.

Fig. 6. The fourth strand is

tucked under the first one and the crown knot is complete.

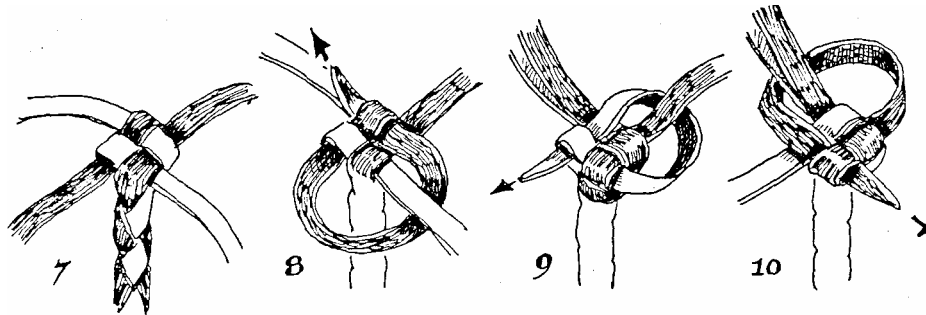

Fig. 7. When worked tight it will look like this. However in this state it is neighbour and then tuck it back likely to work loose and so some under itself.

Do this with each strand in turn.

Some extra work must be done to make it firm.

There are various ways of doing this but the one described here is an easy one to remember.

Fig. 11. When you come to the last strand you must put the strand under two layers as shown. If this is not done the knot will be uneven. Fig. 12. Work the lace as tight as possible and trim it off flush.

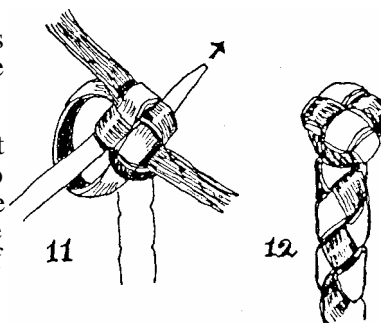

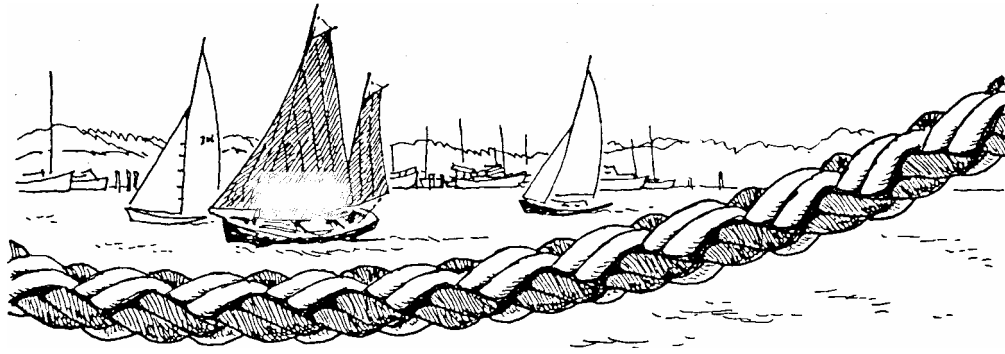

## Doubled Four Plait

Ship's hawsers used to be of plain-laid rope, but these days they are more often a doubled four plait.

The sketch shows a typical one noted in Cairns Harbour, using contrasting colours. This technique enables one to build a heavy rope from whatever light rope is available.

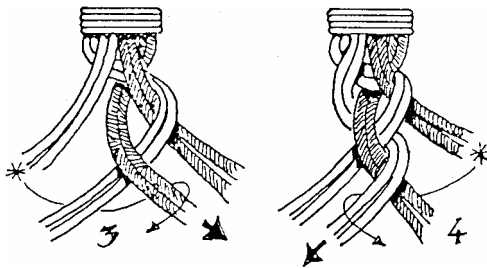

Fig. 3. Come around the back and between the opposite pairs. Take up the pair marked \*.

Fig. 4. Come around the back and between the opposite pairs. Take up the pair marked \*.

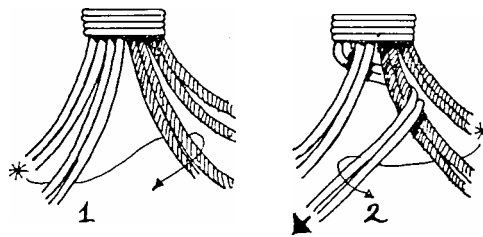
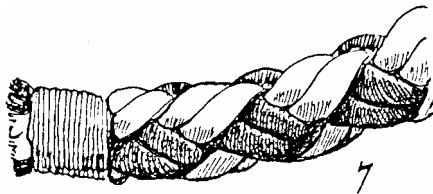
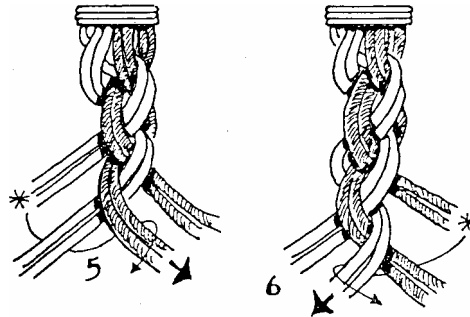

Fig. 1. Take eight lengths of rope and put a whipping on the end. Short whipping is illustrated on page 118 and long whipping on page 121, either can be used.

The plaiting system is ordinary four plait, but taking up the ropes in pairs. Take the pair marked \*.

Fig. 2. Come around the back and between the opposite pair. Take up the pair marked \*.



Figs 5 & 6. Continue following the same sequence.

Fig. 7. When all the rope is used up put a whipping on the end.

## FOUR PLAIT ROUND A CORE

The four plait can be worked as shown above, or it can be worked around some sort of core.

The core can be solid, or it can be something like a length of rope. From the five plait upwards it is usual to always work the plait around some sort of core.

When you arrange the lace around the core the strands should always just touch each other. If they do not then select a narrower core or wider lace, otherwise the finished job will probably show gaps in it.

Whips are always plaited around a tapered core which is called the belly of the whip.

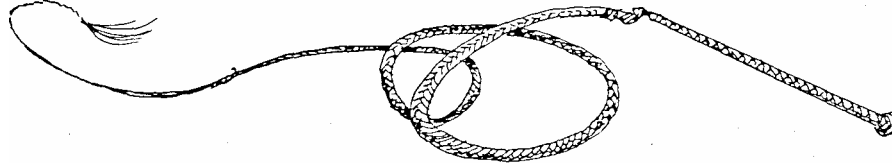
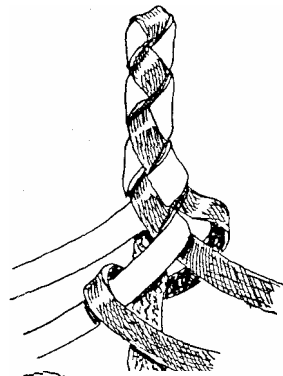

## Five Plait (round)

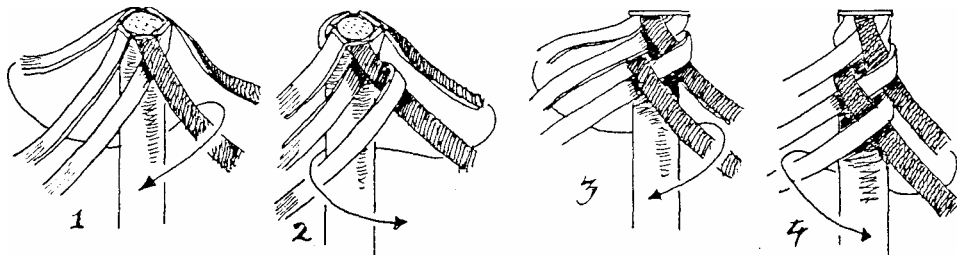
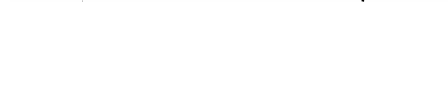
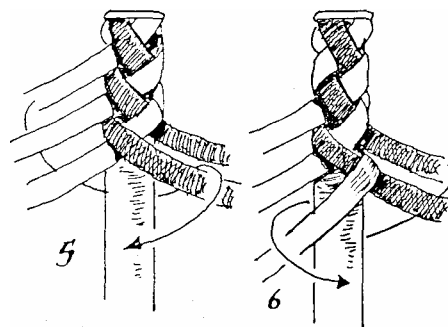

Fig.1. Tie the five strands to the core, crossing two of them as shown. Bring the upper left strand around as shown by the arrow. Fig.2. Bring the upper right strand around as shown by the arrow, and continue this sequence.

**ANOTHER METHOD.** The above method is the easiest to remember but there is another method. It follows the same general idea except that on the left side you come through between the top and middle strands instead of between the top and lower strands.







## Six Plait (round)

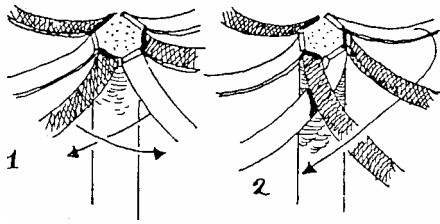

Fig. 1. If using two colours place the six strands as shown and tie them onto the core. Cross the two front strands as shown by the arrows.

Fig. 2. Take the back right hand strand and bring it across as shown.

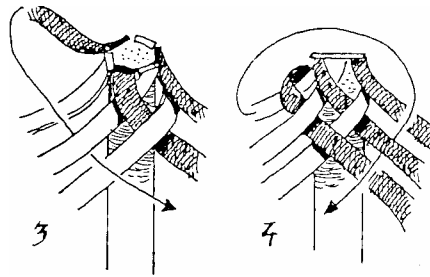
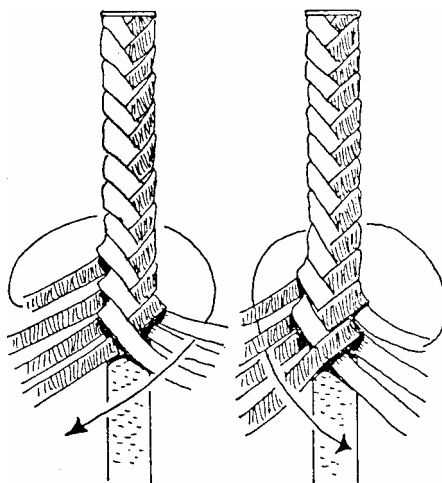
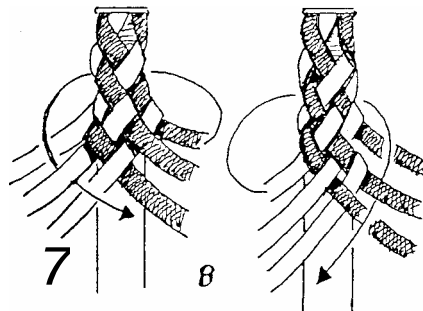
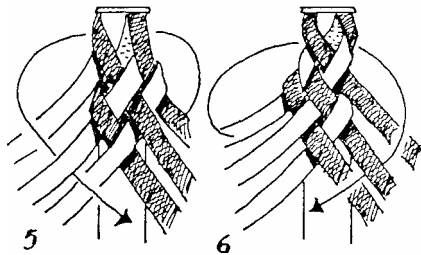

Fig. 3. Take the upper left strand and bring it through as shown.

Fig. 4. Now the sequence begins, Take the upper left strand and bring it around the back as shown, then over-under.

Plaiting continues in this manner.



## Seven Plait (round)

The seven plait is not usually worked for its own sake. However whips are commonly worked with an eight plait, and as the whip tapers strands are worked in and dropped so that it will end up as a four plait.

Many whipmakers drop two strands at a time, so that they work an eight plait, then a six then a four. Others may drop only one strand at a time, and so will need to know all the plaits down to four.

Four strands are arranged on one side and three on the other, and the sequence is shown by the arrows.



## Eight Plait (round)

The eight plait is both useful and attractive, and is an easy one to remember. It is always worked around a core, either solid or flexible.

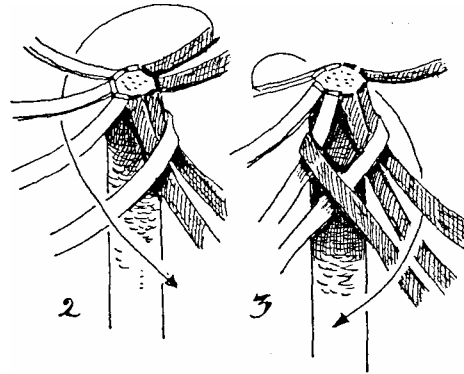
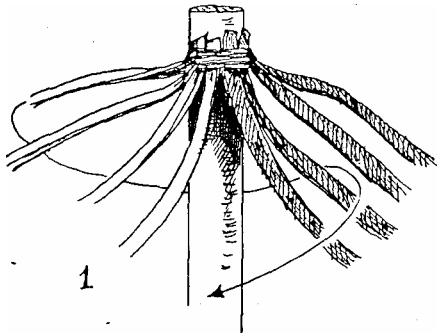
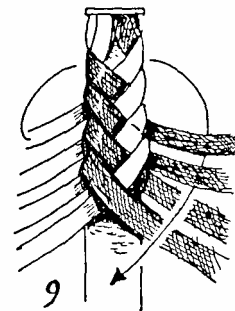
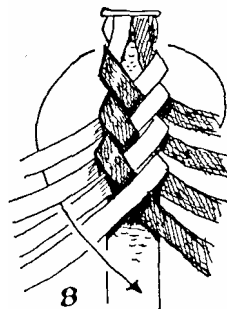
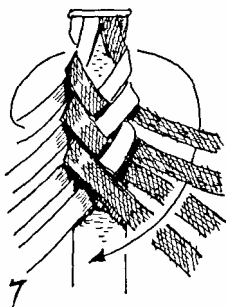
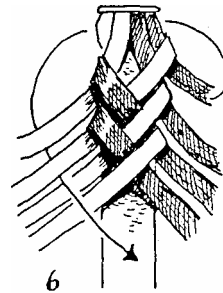
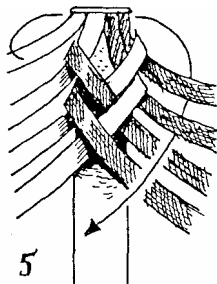
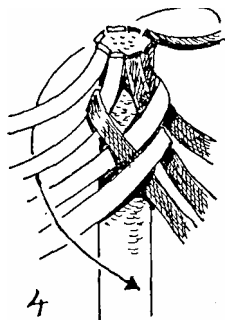

Fig. 1. Tie the strands around the core. For a good job the strands should all touch each other when they are tied around. If they do not do this the finished job may show gaps.

Take the back left hand strand, bring it around the back and through the middle of the opposite four.

Fig. 2. Take the back right hand strand and bring it around the back and through the middle of the opposite four.

Continue the sequences as shown in the drawings.





## Eight Plait

ANOTHER METHOD

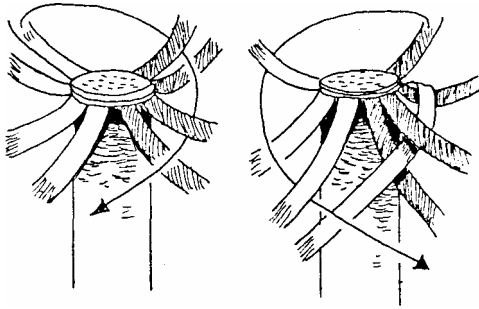

The eight plait can also be done in an over one-under one sequence. Although this is much slower than the above method it is often used by whipmakers who will use the fast method for the bulk of the whip but include short sections of this plait as a decorative touch.

The above sketch shows what it looks like when the change is made from one to the other.

The under one - over one sequence can be used for a ten plait, but this plait is not often used. The method is the same as that shown for the 8 and 12 plait.

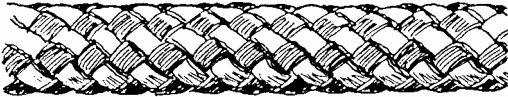

## Twelve Plait (round)

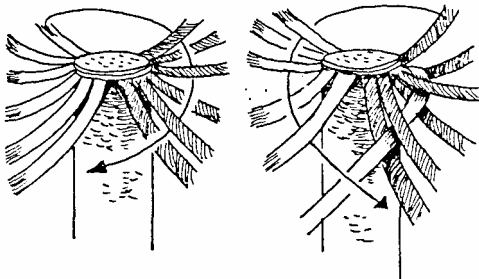

The under one - over one sequence can be used for a twelve plait, and also for a 14, 16 and so on, but it is a slow method and not often used.

The sketches show the sequence to be followed.



## Coachwhipping

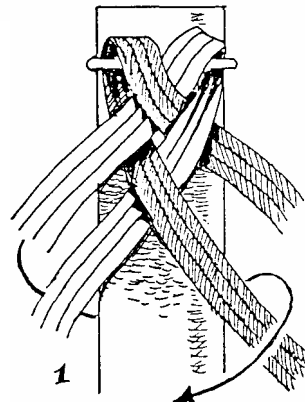

Coachwhipping is a much faster method of plaiting with twelve strands.

The twelve strands can be tied onto the core, or six strands can be doubled and put together as shown in fig. 1.

The strands have to be given a twist so that the good side is showing on all strands.

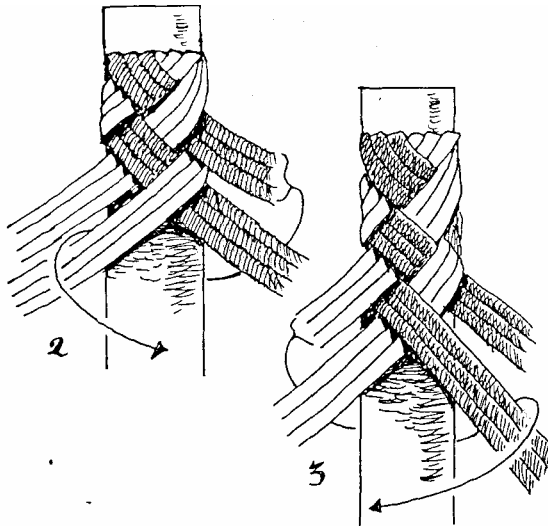

Figs 2 & 3. The plaiting sequence is quite simple, it is the same as a round four plait, except that you work three strands each time.

Coachwhipping can be done in a variety of ways, for instance 16 strands can be put into pairs and worked as an 8 plait and so on.

Coachwhipping can be used in many ways, worked in rope; on ship's railing or in leather strands on whip handles.

## Short Whipping

This is the easiest whipping to remember. Its only limitation is that it cannot be made as long as the long whipping described elsewhere. This is because the whipping must be put on as tightly as possible, and if you make it too long it becomes difficult to haul the end through when finishing.

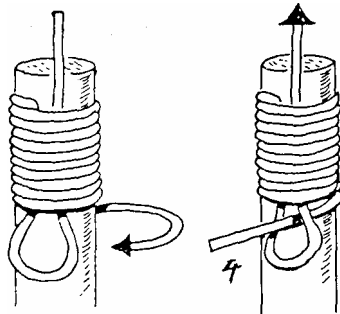
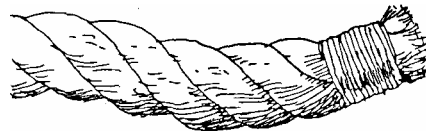

Figs 3 & 4 When sufficient wrapping has been done the end is taken through the loop.

Figs 5 & 6. Pull on the end sticking out the top, this will cause the loop to tighten and pull the bottom end inside the wrapping. Stop when you judge the end to be half way up inside. Trim both ends flush.

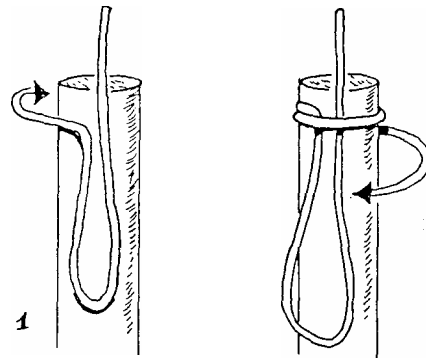
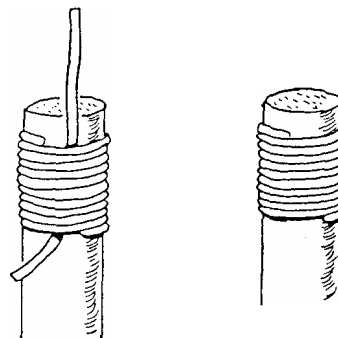
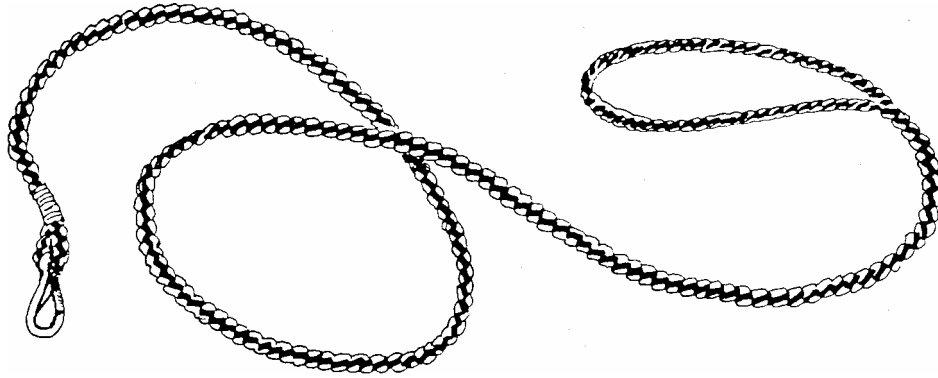

Fig.1. Bend the cord as shown. Leave enough end sticking up to allow a good grip later.

Fig.2. Begin wrapping as tightly as possible.







## A Dog Lead

The Doubled Four Plait is a good one to use when you wish to put a loop or handle at one end of a rope, as for instance when making a dog lead.

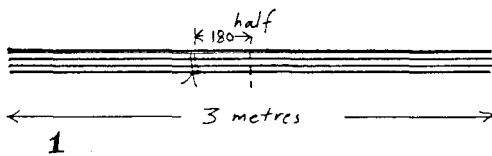

Fig. 1. For a lead a little over a metre long you will need four lengths of cord, each three metres long. By using two different colours an attractive pattern can be created.

Divide the cord in half, come back 180mm and tie it together with a scrap of thread.

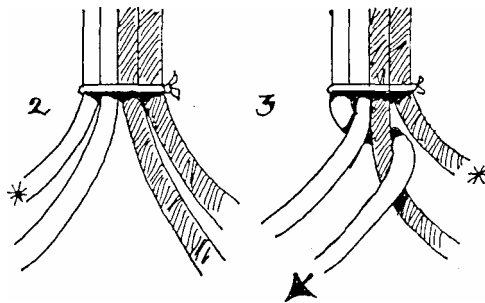

Fig. 2. Divide the cords as shown and pick up the one marked \*. Fig. 3. Take it across the back and between the pair on the opposite side. Pick up the one marked \*.

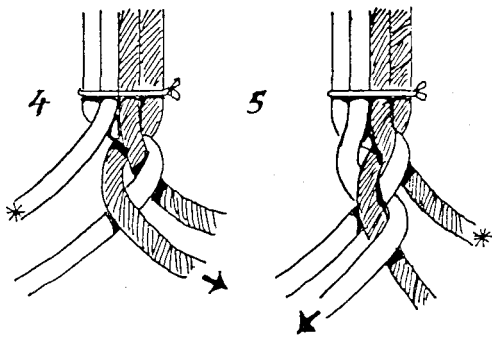

Fig. 4. Take this across the back and between the pair on the opposite side. Pick up the one marked \*.

Fig. 5. Across the back, through and return. Pick up \*.

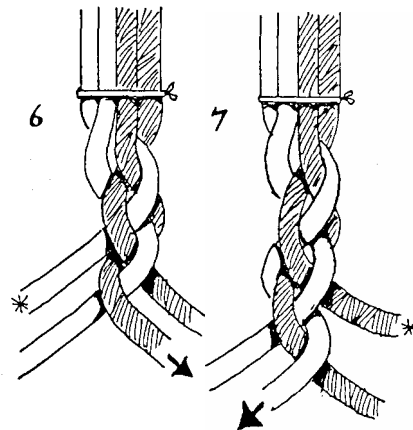

Fig. 6. Across the back and through the opposite pair. Pick up \*.

Fig. 7. Across the back, through and return. Pick up \*. Plaiting continues in this manner.

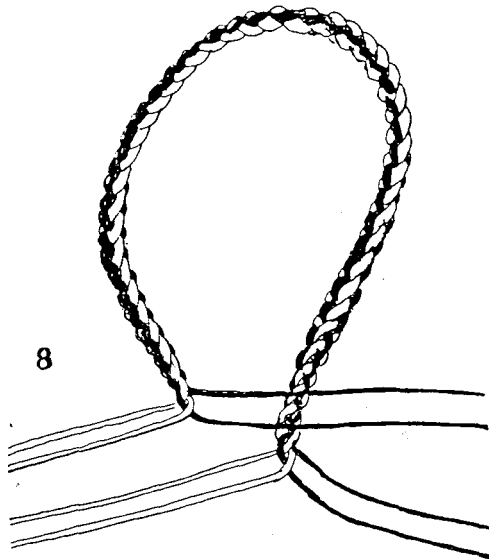

Fig.8. Continue plaiting until there is the same amount each side of the centre line. Form the loop.

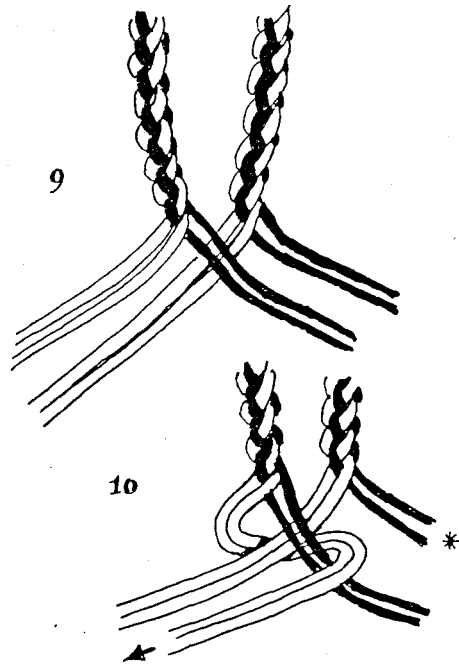

Fig.9. The left side goes over the right.

Fig.10. The same four plait continues, but this time you work with doubled cords. Take the upper left pair, bring them around the back and through. Pick up the pair marked

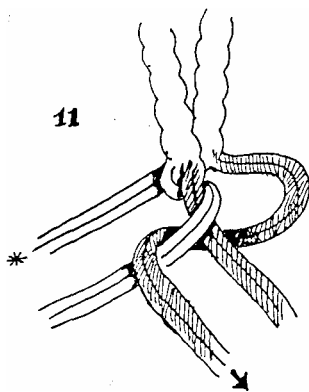
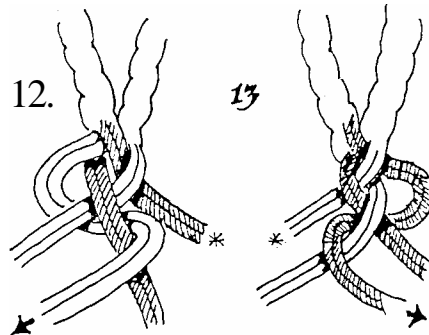

Fig.11. Take them across the back and through. Pick up the pair marked



Figs 12 & 13. Plaiting continues in this same matter, take the pair through as shown and pick up the pair marked \*.

Fig.14. When the plaiting is finished slip the end through the loop in the snap-hook.

If you have the patience it is possible to now take all the cords and run them back up the job following the pattern of the previously plaited section.

However this is a slow job and it is much easier to simply whip the end.

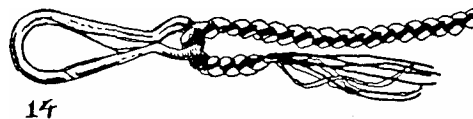

# Long Whipping

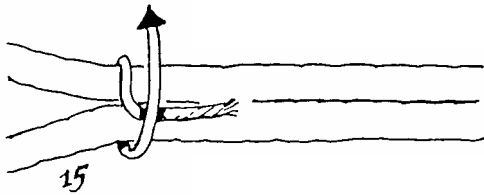
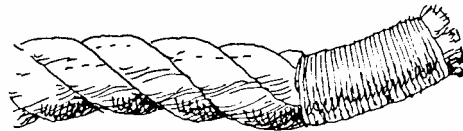

Fig.15. Bend the end of the cord down and begin winding.

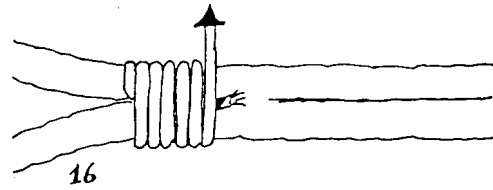

Fig.16. Continue winding until the end has disappeared.

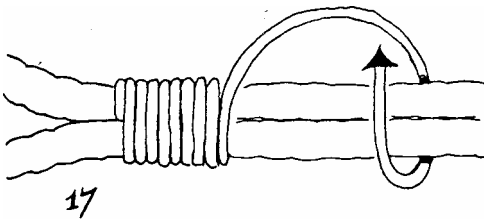

Fig.17. Form a 'bridge' with the cord.

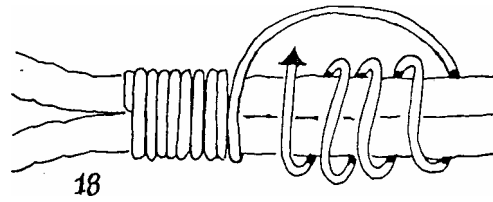

Fig.18. Continue winding in the same clockwise direction but work towards the already wound section.

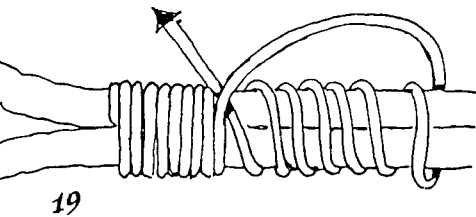

Fig.19. Take the cord out under the end of the 'bridge'.

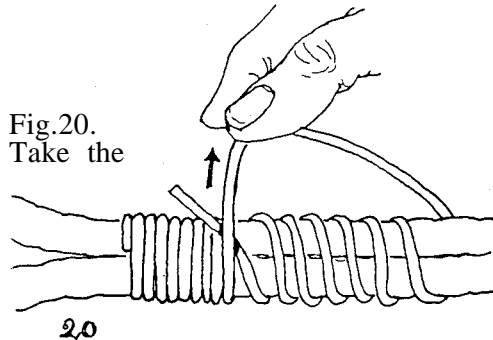

Fig.20. Take the

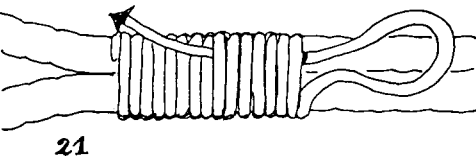
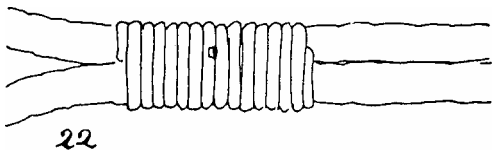

Fig.21. When the winding is finished the job will look like this. Pull the end in the direction of the arrow.

end of the 'bridge' and begin to wind it tightly around.

Fig.22. Pull the end tight and then cut it off flush.

Long Whipping can be used to form a loop, as in this case, or to bind the end of a rope to prevent it fraying.





# General Rule for Flat Plaits

If you care to study the following drawings you will notice that all flat plaits follow the same sequence.

The strands are divided in the middle, then the outside left strand is taken into the middle in an over - under one sequence.

The outside right strand is then

brought into the middle in either an over-under or an under-over sequence, depending on whether the plait is of an odd or even number of strands.

When finishing off the plaiting the neatest system is the one shown for the four plait, this can be used

## Three Plait (flat)

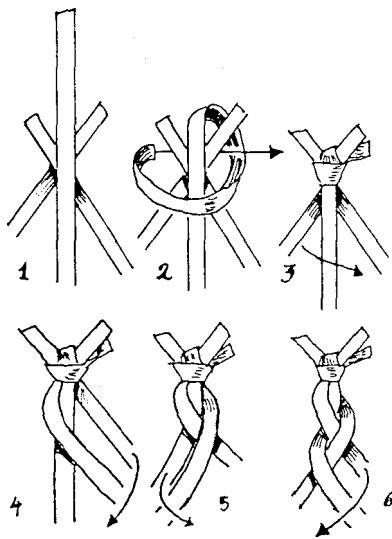

for any number of strands.

I have already illustrated the working of the three plait at the start of this booklet. This is an easy plait to use for a hat band.

Figs 1-6 show how to begin the plait when using lace, and figs 7-9 show how to finish it off.

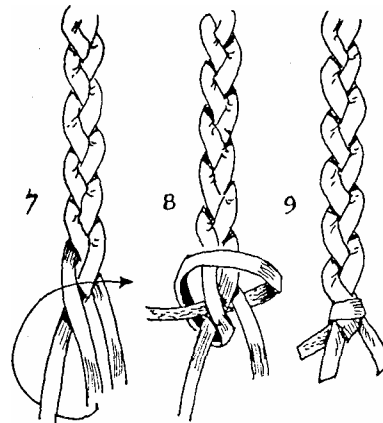

## Four Plait (flat)

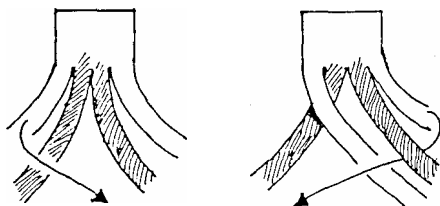

Bring the outside left strand over and into the middle, then bring the outside right strand under-over. Continue this sequence.

When finishing turn the job over

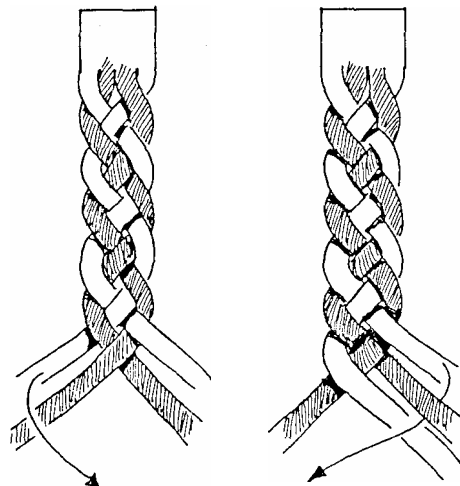

so that the rough side is facing you. Fold each strand down and plait it back onto itself.

Continue plaiting back until all the strands are firm and will not unravel, then trim the ends off neatly.

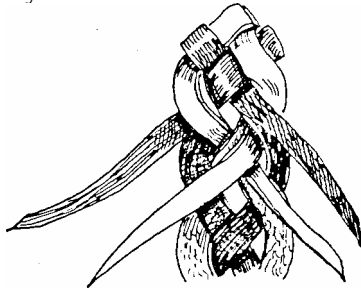

*back view*



## Five Plait (flat)

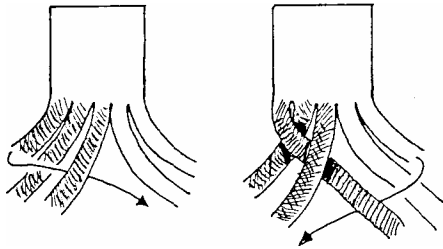

Bring the outside left strand over-under, then bring the outside right strand over-under.

Finish off the same way as the four plait.

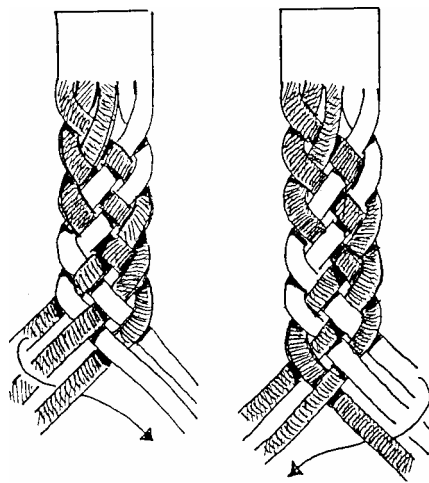

## Six Plait (flat)

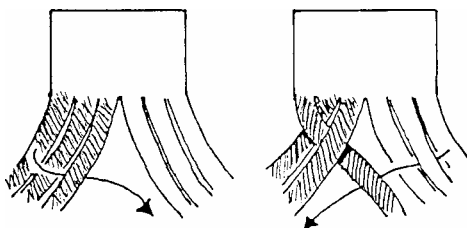

Bring the outside left strand over-under, then bring the outside right strand under-over-under.

Finish off the same way as the four plait.

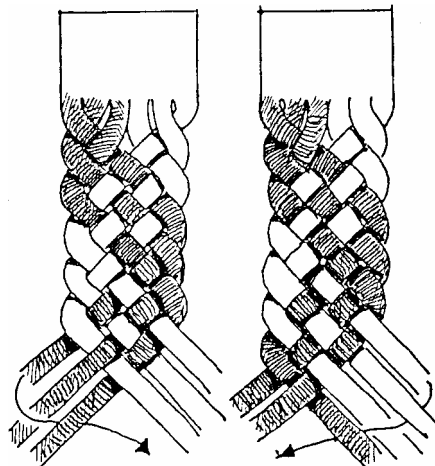

## Seven Plait (flat)

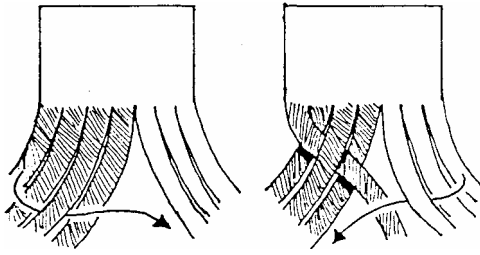

Bring the outside left strand over-under-over, then bring the outside right strand over-under-over. Finish off the same way as the four plait.

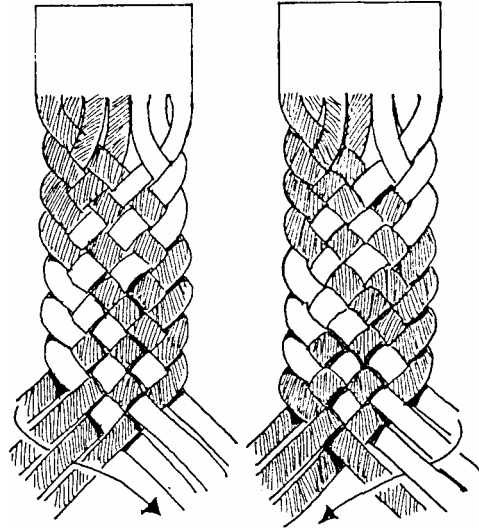

## Eight Plait (flat)

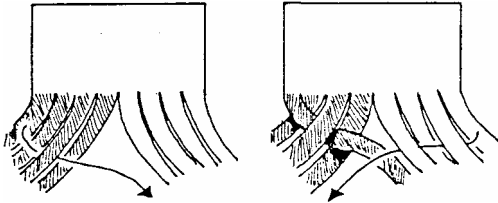

Bring the outside left strand over-under-over, then bring the outside right strand under-over-under-over. Finish off the same way as the four plait.

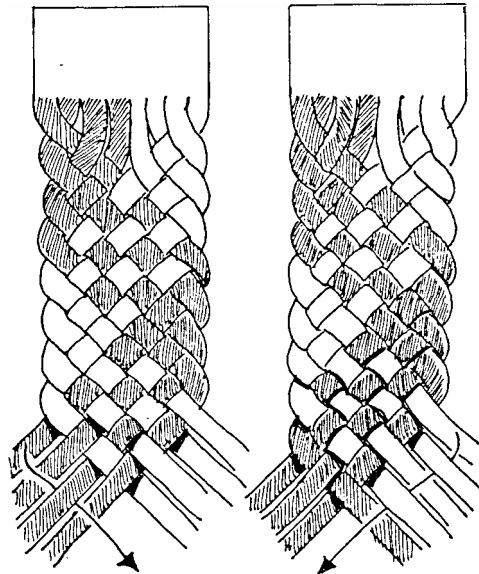

Ten, twelve, fourteen and sixteen plaits are all used in belt making.

All the following plaits follow the same sequence as described earlier, take the outside left strand and work it into the centre, then bring in the outside right strand. Continue this sequence.

To finish up use the method illustrated for the four plait.

## Ten Plait (flat)

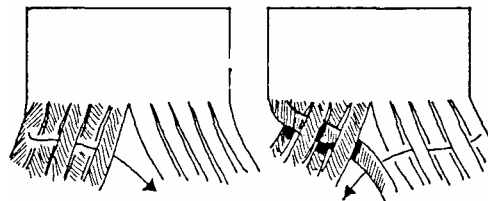

## Twelve Plait (flat)

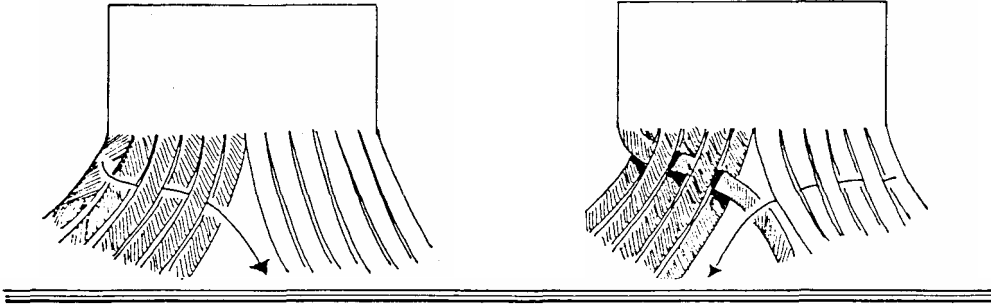

## Fourteen Plait (flat)

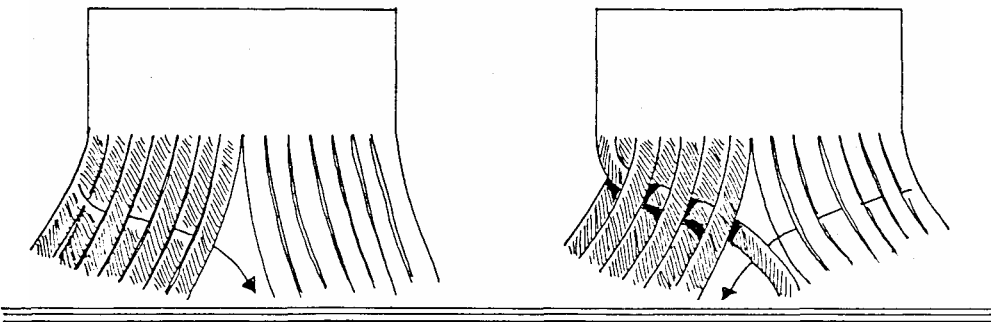

## Sixteen Plait (flat)

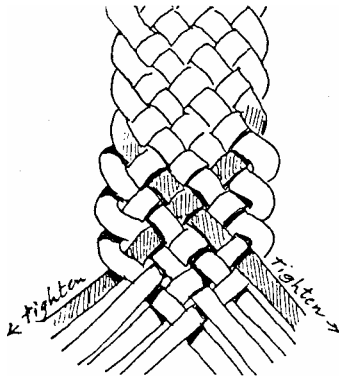
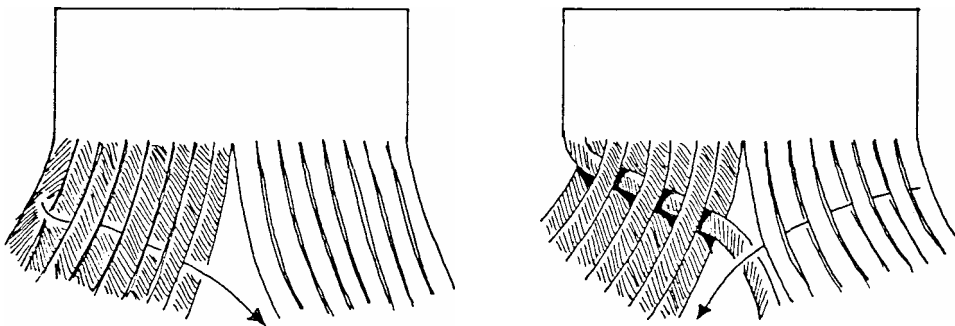

### A USEFUL PLATING TIP

Lindsay Whiteman of Townsville passed this tip to me. Most people tend to tighten the lowest strand as they work, but his method is to tighten the top pair as shown, letting the new work remain loose.

He finds that this gives a much more even job when plaiting belts.

7

# Whipmaking

---

---

part 1

## Basic Stockwhips

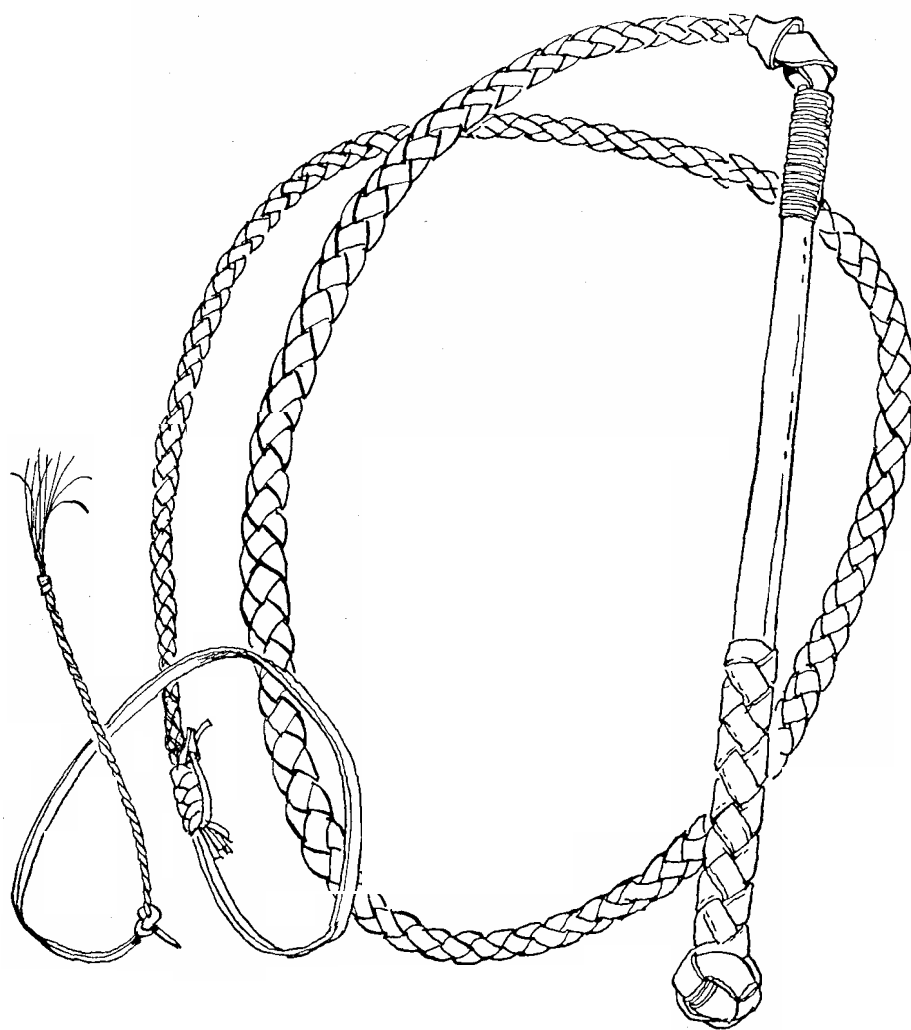

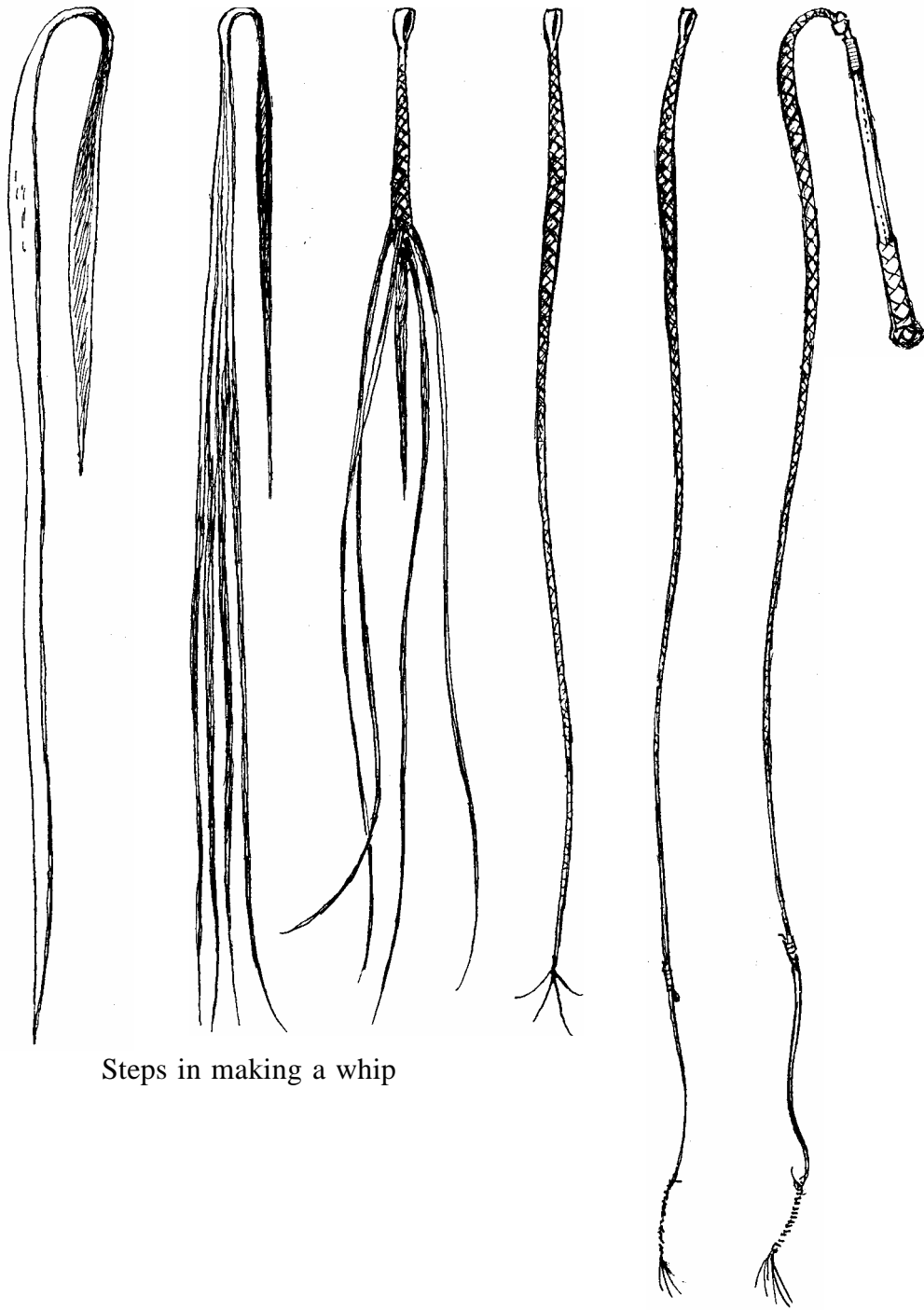

Steps in making a whip

This section deals with one of Australia's traditional bush crafts, the making of the common stockwhip. These whips are usually made by the men who wield them, and are commonly a 4- plait (though instructions are also included for a 6 plait). The leather used is either redhide or greenhide.

Stockwhips are also made from kangaroo hide, but these are much more complicated to make and are often the work of plaiting experts. The making of these whips is described in Whipmaking, part 2.

Greenhide is simply made by pegging out a fresh hide, covering it with a layer of salt and leaving it to dry for a few days. Some people (including a few writers) confuse greenhide with chrome tanned leather. Chrome leather is light grey in colour but when cut the inside is blue-green, hence the confusion. This leather can also be used for whips.

Redhide is a properly tanned leather which has been heavily oiled during the tanning process. It is red in colour.

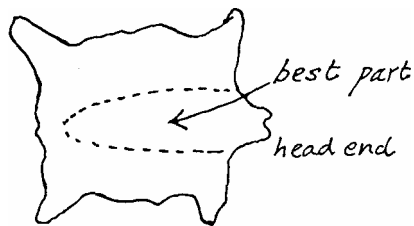

This is how the hide comes off the beast, the best leather is around the shoulders and along the backbone. The tanner divides

the hide along the backbone before tanning and the result is called a side. Leather is bought by the side.

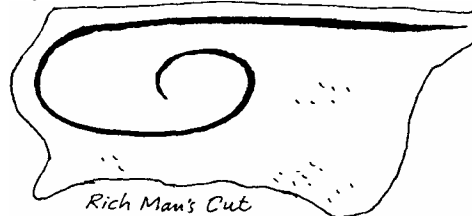

There are a number of ways of cutting out the leather for a whip. The best way is the Rich Man's Cut.

This runs down the backbone and then curves, so as to use only the best part of the leather. The only drawback to this method is that it leaves odd shaped pieces of leather which are hard to use up.

The Poor Man's Cut is used by a lot of whipmakers because it allows quite a number of whips to be made from one side of leather.

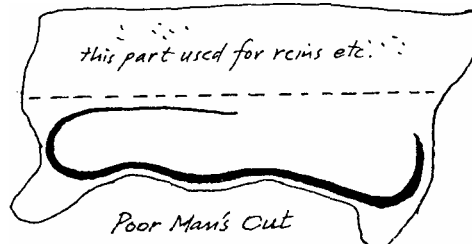

All the thin, weak parts of the belly are discarded before marking out begins. Some whipmakers then shape a smooth curve while others simply follow the general shape of the leather as I have shown in the sketch.

Years ago when I first saw this done by a saddler I was very surprised, but the old fellow said that it saved a lot of leather and made no difference to the final job.

The great advantage of this system is that the strongest part of the leather, the backbone, can be used for making up Bate's girths and reins, where strength is all important.



The professional whipmaker has to make as many whips as possible from a side of leather.

In order to use up as much of the leather as he can he will make quite tight curves when cutting out. If done carefully this does not in any way effect the final look of the whip.

### DIMENSIONS

The dimensions given here will make a whip around 2.3 metres long, but they can also be adjusted to make a whip of any length.

For the sake of clarity the width has been exaggerated in the plan of the whip.

Notice that the whip is in three parts. The longest is the plaited section, then there is the keeper to which the handle will be later attached, and then there is the belly. The belly will go inside the plaited section of the whip and give it the right shape.

The dimensions are given in millimetres. Those on top show the widths at various places.

The width given for the belly is for an average side, it can be wider if the leather is thin and narrower if it is thick.

*Note: the width has been exaggerated in this sketch*

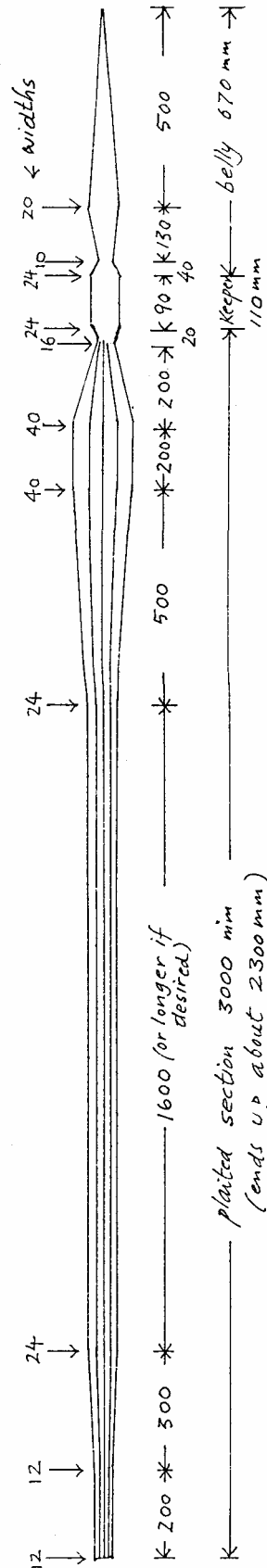



## CUTTING THE STRANDS



Beginning at the keeper the four strands are now marked and cut out. The same width can also be used if making a 6 plait whip.

Having cut out the strands bushmen often take pride in carefully skiving the edges. This makes for a much smoother

finish when the plaiting is done.

However skiving calls for a steady hand and an amazingly sharp knife, so if you feel unsure about it then do not bother.

Rough greenhide whips are often left unskived, and even plaited with the hair still intact, or only roughly scraped off, the theory being that it will wear off with use.

---

---

## SKIVING

In our saddlery shop we use jeweller's rouge to keep the knives sharp. This comes in stick form and some leather shops keep it in stock.

For the home workshop the rouge can be rubbed on the rough side of any small scrap of leather and this then used as a strop.

Because we use round knives a lot we find it best to glue a strip of leather to a board, rough side up, and this gives a

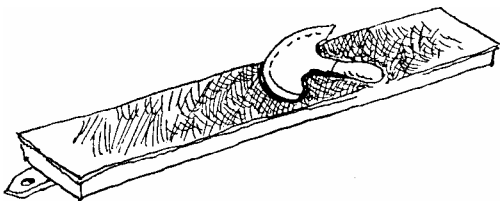

firm surface when stropping.

Only when the knife is sharp enough to shave the hairs on the arms can skiving begin.

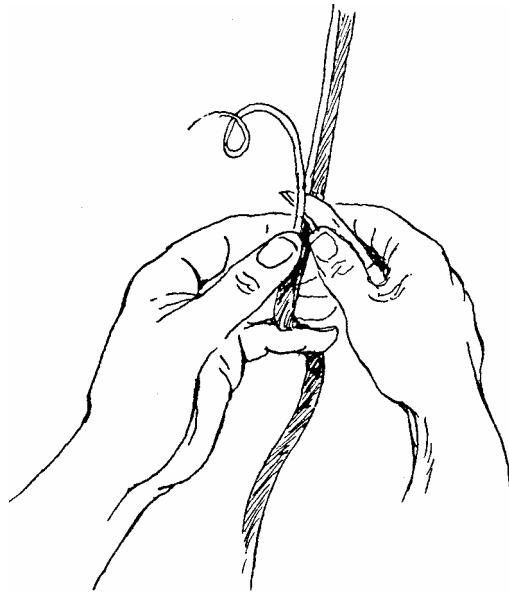

Everyone develops their own method of holding the leather and the knife when doing this work, and the sketch shows a typical style.

As you skive you walk backwards, so make sure the area is clear and that the whip is firmly tied to something.

If the knife is really sharp then skiving is easy, if not then continue sharpening the knife. I have seen an Aboriginal stockman spend a full hour patiently sharpening a knife before starting work.

There are three popular ways to skive the strands, and they are shown in the sketch. The first is the most convenient, the leather is skived on either side of the face side.



Some whipmakers like to skive the underside of the leather as shown in the second drawing, but this can often be a problem if

the leather has a furry back.

### ROLLING THE BELLY

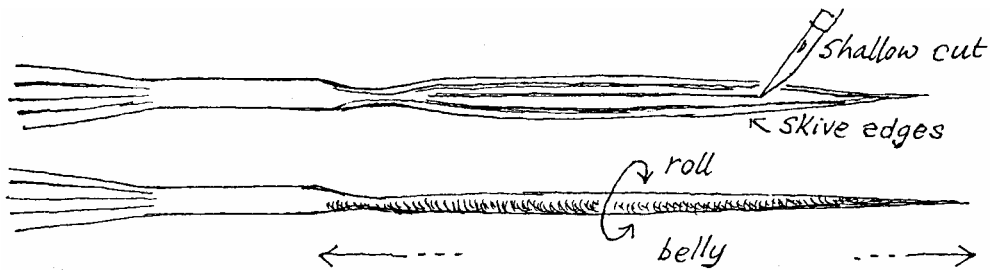

Before plaiting begins the belly must be rolled, if this is not done then you will end up with a rectangular whip!

a few shallow cuts in the face of it. Now roll it as tightly as possible.

First skive the edges. If the leather does not roll easily make

Once rolled it may be a help to keep it together with a cotton thread or a horsehair.

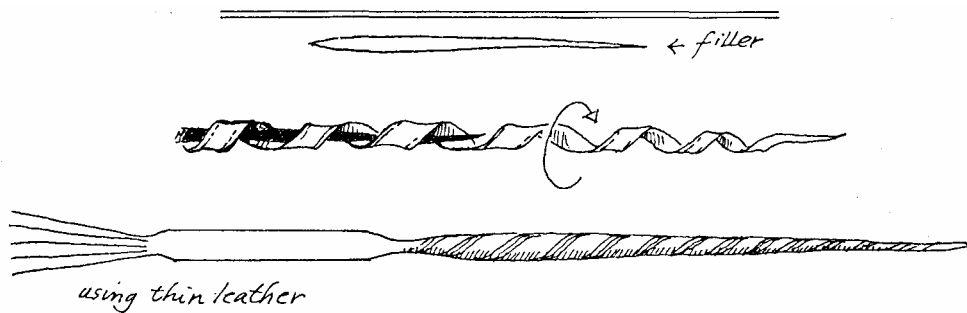

If you are working with a relatively thin leather then the belly may not be thick enough when rolled in this way.

scrap of leather which is used as a filler. This should also be held together with a length of cotton to keep it the right shape until it is plaited over.

In this case the leather is made to spiral around a smaller

It is important to get the belly nice and smooth before plaiting is begun, so give it a good firm rolling under your boot or under a piece of board until the shape is right.

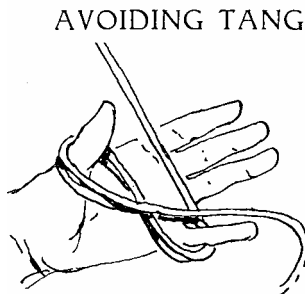
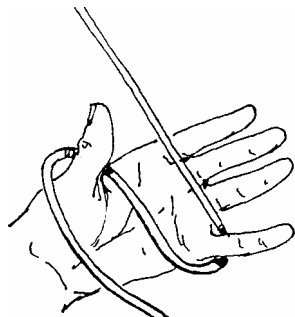
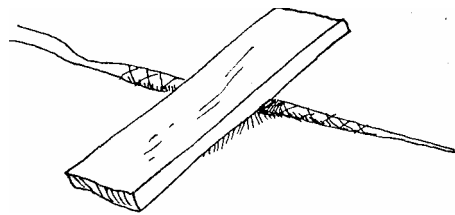

AVOIDING TANGLES



Plaiting with long strands soon creates tangles around your legs. To avoid this skilled plaiters tie the loose ends into hanks.

There are a number of ways of doing this, and the one illustrated is suitable for whipmaking.

As plaiting continues a tug on the hank will release more strand.

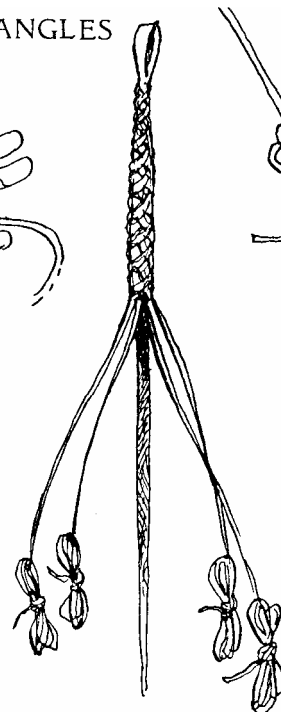

## PLAITING THE WHIP

Hang the keeper over a nail with the belly hanging down in front as shown in fig. 14.

Now bring the strands across the front as shown in figs 15, 16, 17.

An ordinary 4 plait can now begin and this is a very easy plait to remember. Take the highest strand around the back, between the strands on the other side and over to its own side as shown by the arrow in fig. 18.

Again take the highest strand, which will now be on the

opposite side, and take it around the back and between the strands on the opposite side as shown in fig. 19.

Plaiting continues in this way until the whip is completed. Leave only 120mm unplaited.

Pull the strands as tight as possible while plaiting and try to avoid holes. Holes will be seen if the belly is too thick or has not been rolled tightly enough.

We once had a very strong girl called Anita making whips for our saddlery shop and when she plaited a whip she could make the oil squeeze out of the redhide!

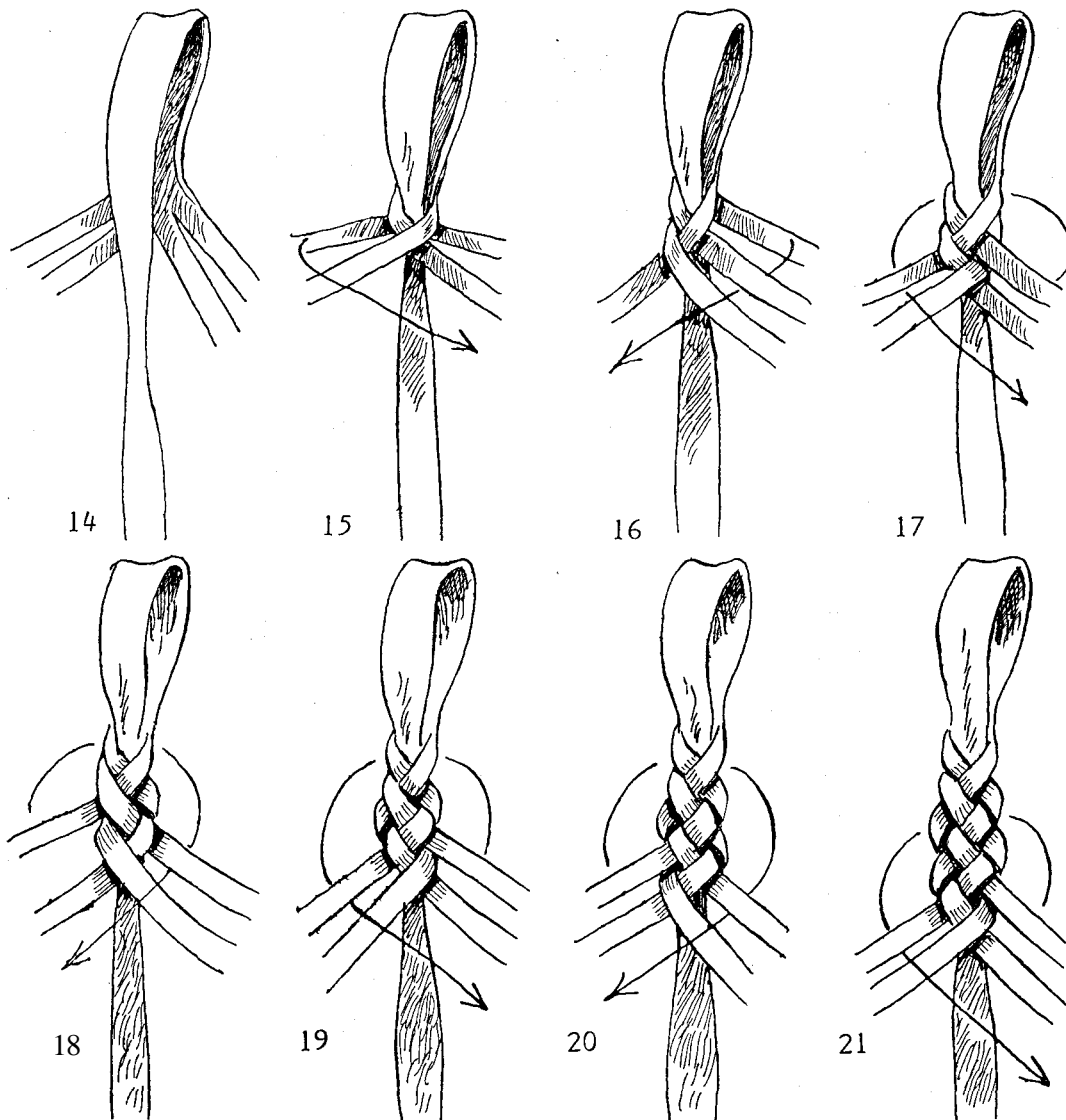

### PLAITING SOAP

In order to get a good, firm whip the strands must be plaited as tightly as possible.

If the strands are greased in some way they can be pulled in so much tighter. The most common substance used in the bush is ordinary fat, because it does the job and is easy to obtain.

Mutton fat is considered to be better than other fats.

Plaiting experts often make up their own plaiting soaps, which they consider to be better than plain fat. Here is a common recipe.

4 parts mutton fat. 1 part soap. 3 parts water, (all by volume)

Slice the soap up as finely as possible so that it will dissolve faster or, if you have the time, let the soap sit in the water overnight until it has dissolved.

Heat the water and soap and stir until the soap has all dissolved.

Add the fat and let the mixture boil, stirring all the while. After a few minutes it can be set aside to cool.

When cool it should be firm but light to the touch. If it is watery then put it back on the heat and continue stirring until the water has reduced a little more.

Do not overfill the pan or leave it unattended on the stove.

I sometimes add one part of beeswax to this mixture as this then gives the leather a dressing at the same time.

Another mixture, which also acts as a leather dressing, is 4 parts fat, 1 part wax and 2 parts glycerine. Simply melt together

and then set aside to cool. Stir a couple of times while the mixture cools to prevent the ingredients from separating.

Plaiting soap is also a great help when plaiting belts, and its use will result in a much tighter job.

When working with greased strands you will find that you have to wrap the strands around the fingers in order to get a good pull, it does not take long to develop a technique for doing this.

Pull each strand tight before

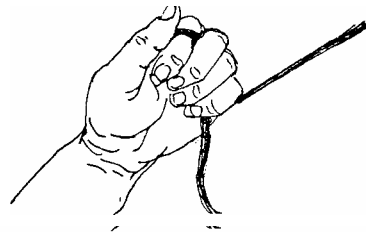

---

### ATTACHING THE FALL

The fall is a strip of leather attached to the end of the whip. The end of the whip gets a lot of knocking around so it is better to have a fall that can be replaced rather than let the plaited end take the damage.

The fall is usually made from the same leather as the rest of the whip, but redhide falls are considered the best because they do not dry out and crack as readily as greenhide.

The exact dimensions are according to taste, but 700mm long is average. The width is decided by the thickness of leather, it should be both thin and strong.

It is best to cut the fall from the best and thickest part of the

working it into the next position.

side, along the backbone, and it can then be made almost square in section for most of its length.

For the sake of appearance a scrap of leather can be wrapped around the fall and pulled vigorously up and down to round off the edges, or they can be skived.

The fall is made a little wider at the top and a slit is put in it just large enough to take the end of the whip.

It is tied on as shown in figs 25-29, and when the last hitch has been made the end is put through the slit as shown in fig.28 and then the fall is pulled down hard. This prevents the fastening coming loose.

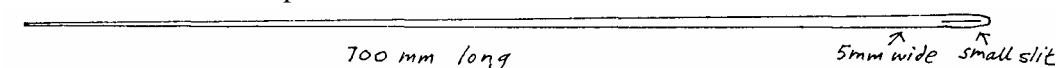

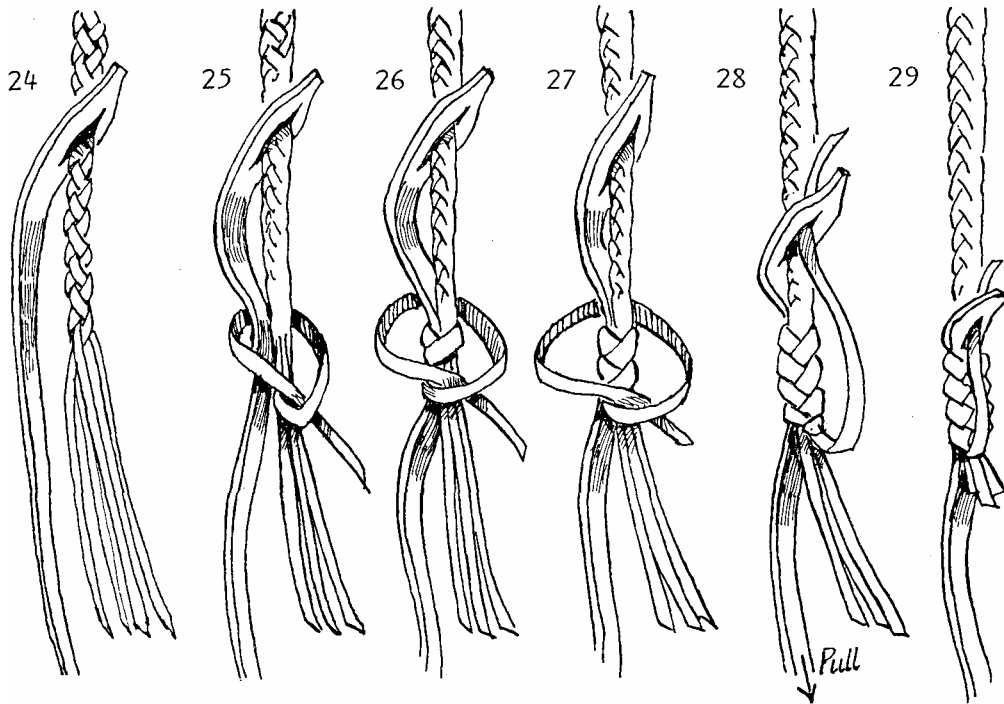

**ROLLING THE WHIP** When the fall has been attached the whip should be rolled. This should be done as firmly as possible using a board and putting all your weight behind it.

The effect will be to produce a good smooth finish on the whip.

Rough whips are often simply rolled under the boot.

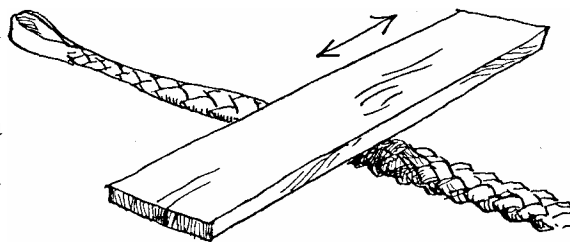

#### MAKING THE CRACKER

When a whip is cracked the sharp noise is caused by the cracker at the end of the whip breaking the sound barrier.

Traditionally the cracker is made from horse hair which the stockman pulls directly from the horse's tail.

Nylon twine also makes excellent crackers and we use spools classed as 210/18 ply in

our saddlery. Other materials can also be used including most synthetic twines. In the old days silk thread was once very popular.

The traditional way of making a cracker is to take a few lengths of horse hair or twine around 700 mm long and grip one end firmly in the teeth while twisting the other. The sketch shows a stockman friend doing this .



The direction of the twist does not matter with horse hair but with twine it is thought best to twist it in the opposite direction to which it has been made, but for all practical purposes this does not matter.



After a certain amount of twisting has been done the cord thus formed will be seen to begin to kink. At this stage it is grasped in the middle as shown in the second sketch, and the two ends will be seen to spiral around each other as if by magic and so create the cracker.

==> SPEEDING UP THE JOB <==

If a number of crackers are to be made the job can be speeded up by bending a small crank from a scrap of fencing wire. This takes only a few seconds and all that is then

needed is a nail or hook to take the other end of the twine (this cannot be done with horse hair).

Figs 33-35 show how the cracker is formed.

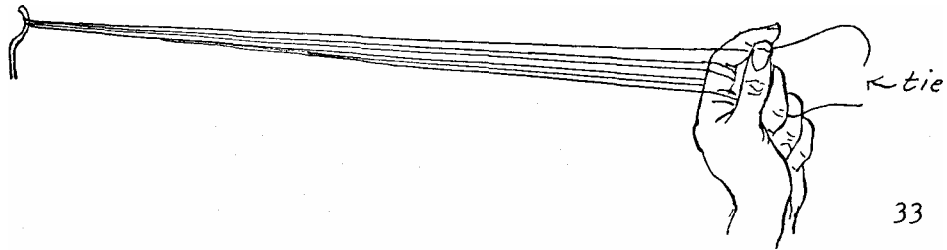

33

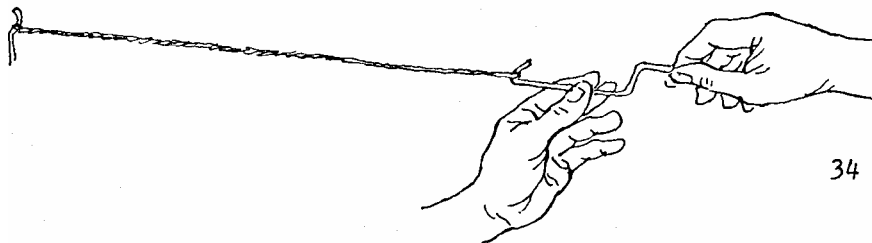

34

## FINISHING OFF THE CRACKER

When the cracker has been twisted it looks like fig.36. Many people then simply tie an overhand knot to stop it unravelling.

Figs 37-9 show a neater knot.

## FASTENING THE CRACKER

Figs 40-41 show the simple bend that fastens the cracker to the fall.

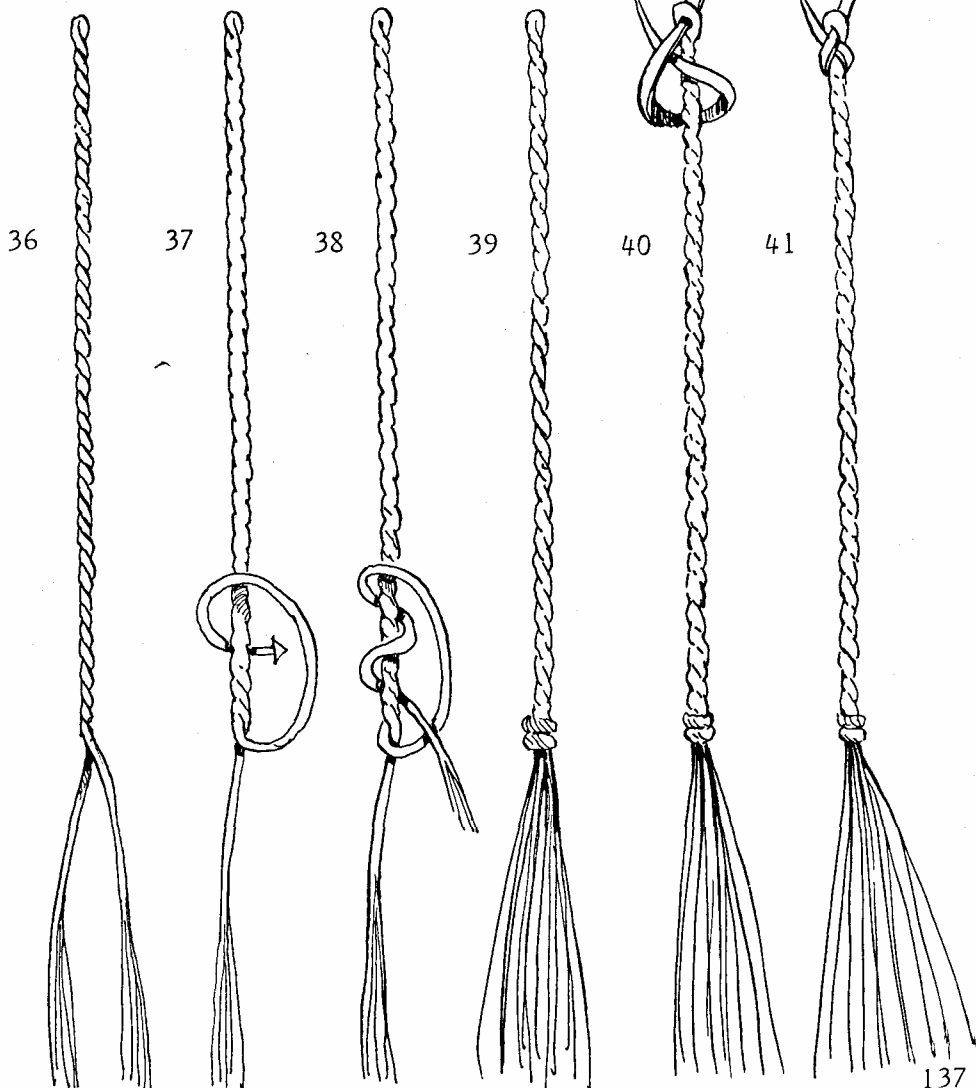
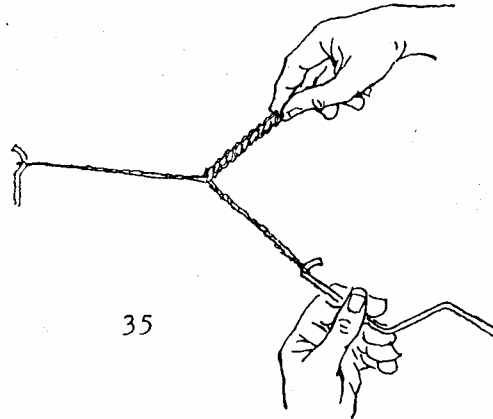



## MAKING THE HANDLE

Any strong timber can be used for a whip handle, but old stockmen warn against using any wood that splits into long sharp slivers, as this could cause injuries in a fall from a horse.

Cane is popular for whip handles. In north Queensland this

can be obtained from the lawyer vine that grows in the jungle.

Offcuts can also be obtained from the makers of cane furniture.

Length is to taste, but usually around 450 - 500mm.

### ATTACHING THE KEEPER



220 x 15 skived at ends

The keeper should be of strong supple leather skived thin at each end as shown.

It is a good idea to cut a shallow groove in the end of the handle so that the binding cannot slip, fig. 44.

Figs 45-47 show the best way to fasten the binding. It may take a minute or two to understand the way of finishing off but it is well worth learning.

The binding is usually done with strong twine. Leather lace can also be used in the same way but is not as strong.



44

To get the binding as tight as possible tie one end of the twine to something and wind the handle around the twine instead of winding the twine around the handle.

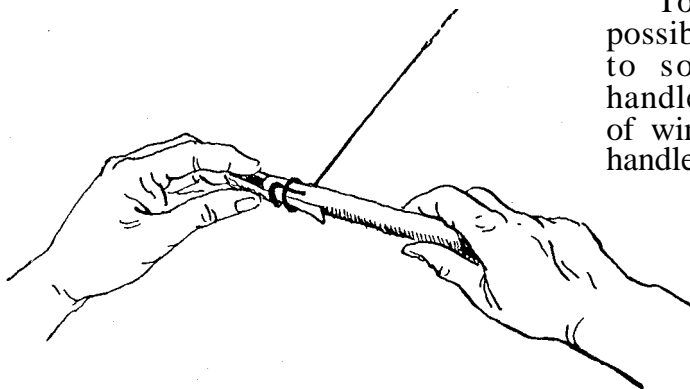

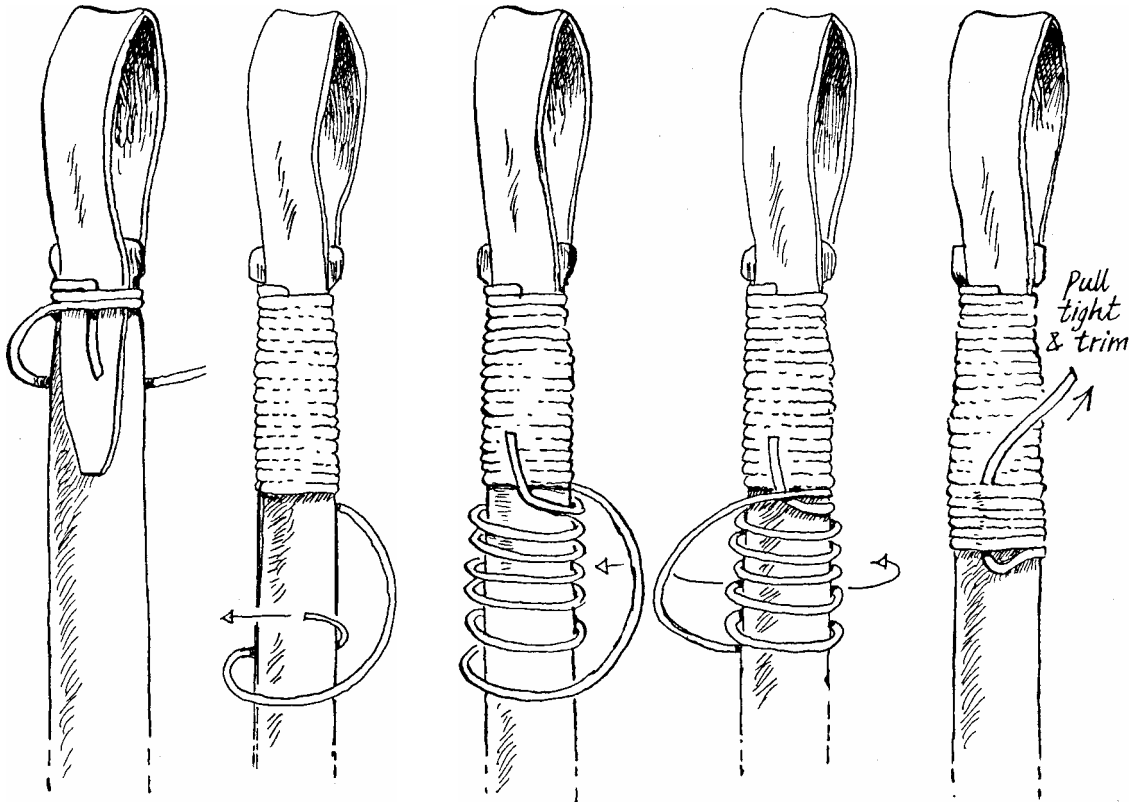

45-47

### ATTACHING WHIP & HANDLE

The handle and whip are looped together as shown.

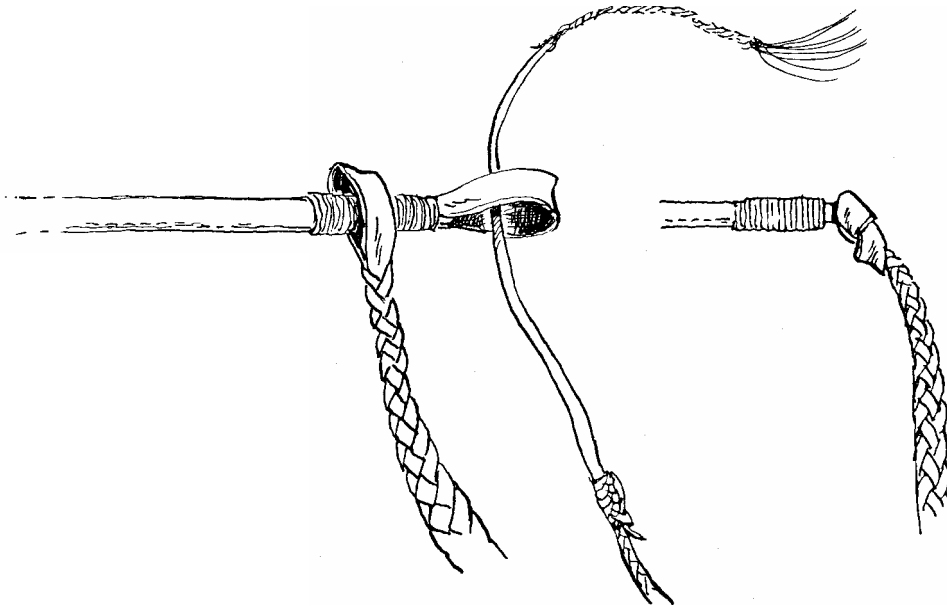

## COVERING THE HANDLE

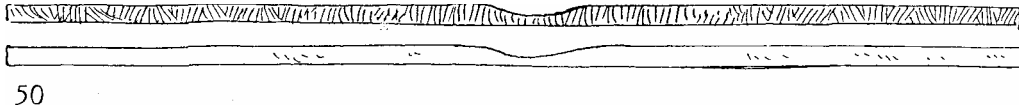

The leather for covering the handle can be taken from the thinnest part of the hide. Cut two strips each one metre long, or longer if the handle is extra thick.

Trim them down to half width in the middle as shown in fig.50. The width of the strands is calculated by wrapping a scrap of the same leather around the handle and making a mark.

Divide this measure into four parts to calculate the width of the strands. They will be around 20mm.

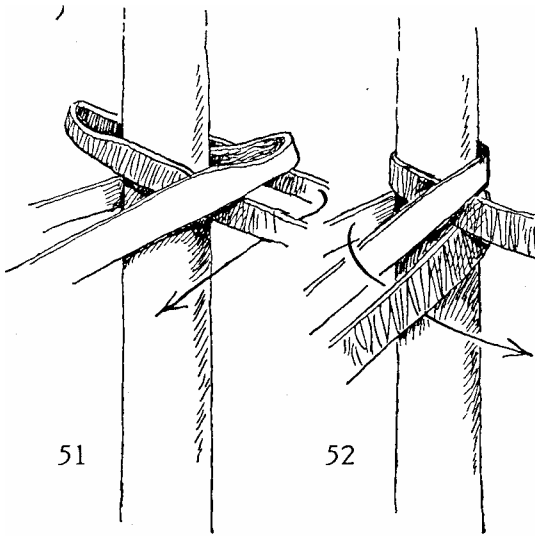
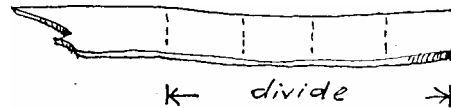
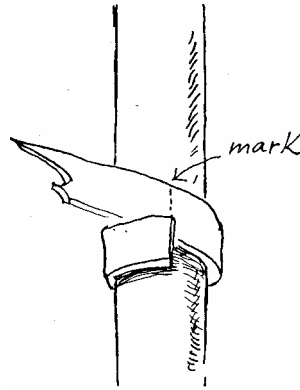

51

52

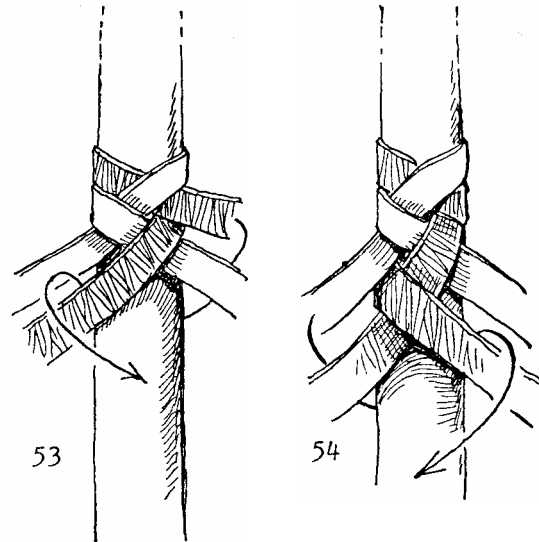

53

54

Wrap the strands around the handle 150mm from the end and begin plaiting as shown in figs. 51-52.

Continue as in figs. 53-54 using the same 4 plait as was used to make the whip.

When the end is reached put a tack in either side to hold the strands firmly in place.

If you are working in the bush with no tacks handy then cut a groove in the handle and tie twine tightly around the strands, making sure that the twine sits flush in the groove.

Now give the handle a good roll with a scrap of timber to flatten and smooth the plaiting.

If the strands are thick it looks better if the edges are skived before the plaiting is done.

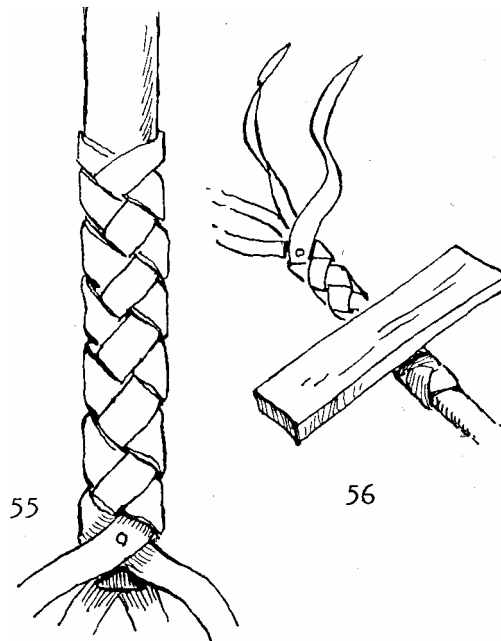

### FORMING THE KNOB

The knobs formed on fancy whips are quite complicated but this is a simple one. It is an elaboration of the Crown Knot, but is usually known in the bush as a Dog's Knot (in bush slang dog's testicles are called dog's knots).

The knob is formed in three moves. First tuck each strand under the one next to it as shown in fig. 57.

Due to the angles at which the strands come out from the handle plait this knot will begin by looking a bit uneven and one sided.

Fig.58 shows how it should look when seen from above, and to encourage it in this direction it should be given a few good thumps on a firm surface.

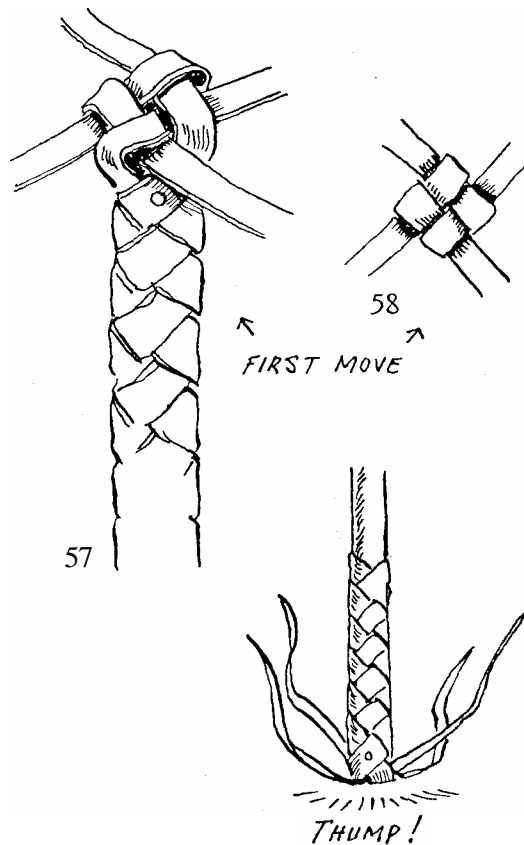

The second move consists of passing each strand under the one next to it.

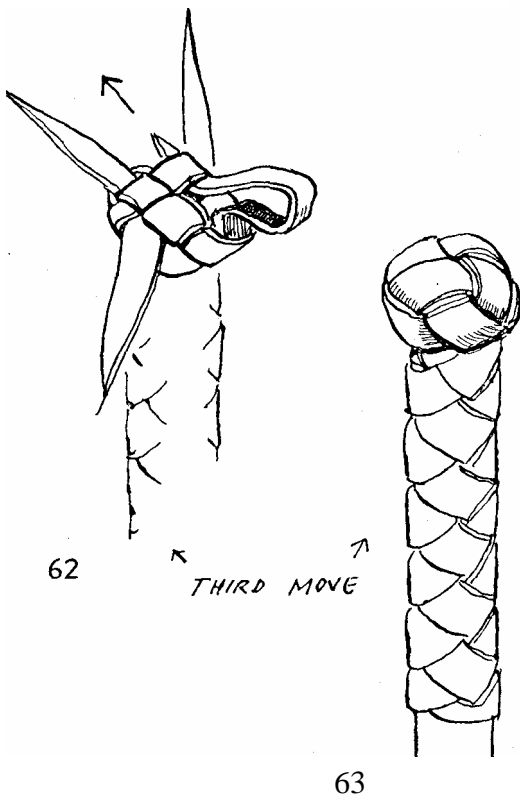
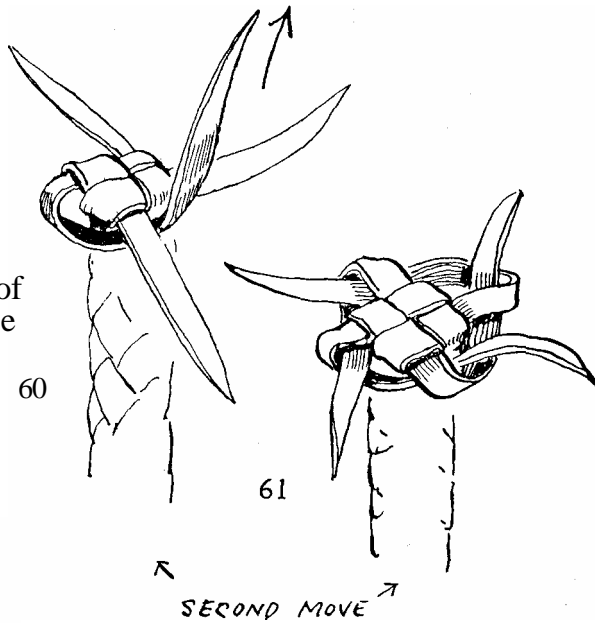

The third move follows the first move as shown in fig.62. In this way each strand is locked under the strands that were put down first.

A fid or a screwdriver will be needed to open up the plaiting to do this move.

When all four ends have been tucked through they can be trimmed flush and should look like fig.63.

Roll the knob firmly beneath the hand on a flat surface to get it smooth.

This knob must be formed as tightly as possible.

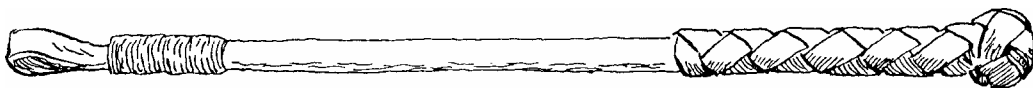

*Note : the width has been exaggerated in this sketch*

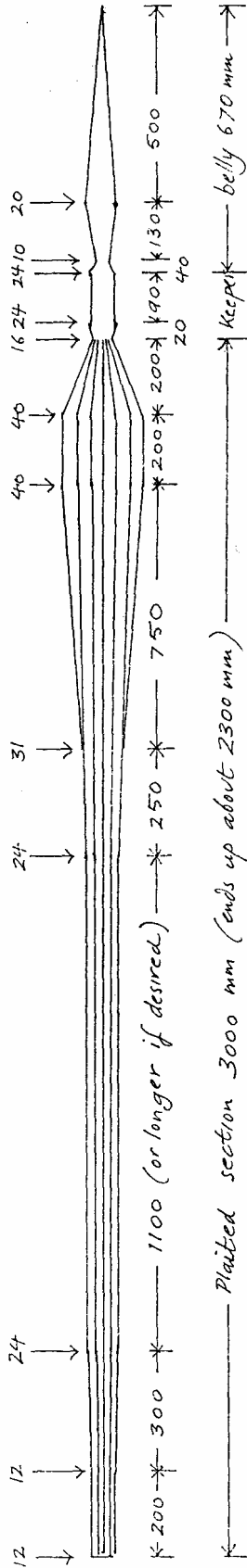

In this plan only the upper part is worked with 6 strands, however the plan can be altered to take the 6 plait almost to the bottom, depending on your skill in cutting.

### SIX PLAIT WHIP

The most common whip is the 4 plait, because it is the quickest and easiest to make. However some people prefer the appearance of the 6 plait, and so a cutting plan is included here.

Begin plaiting as shown in the drawings on the next page.

### WORKING THE 6 PLAIT

The sequence for this plait is that on the right side the strand is taken under the top strand, while on the left side it is taken under the middle strand. This creates the same herringbone pattern on both sides of the whip.

There are two other popular ways of doing the 6 plait. One is to go under the top strand on both sides. This gives a herringbone pattern on one side of the whip and a diamond pattern on the other.

The third method is to go under-over-under on both sides. This creates a diamond pattern.

18

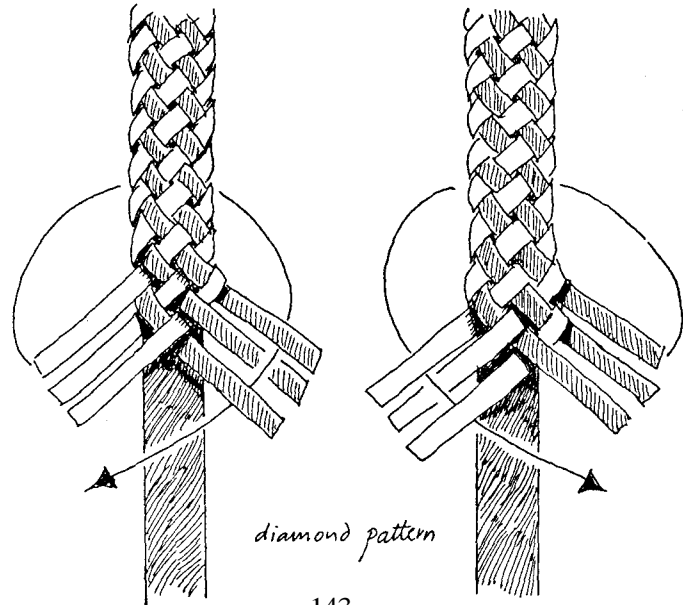

143

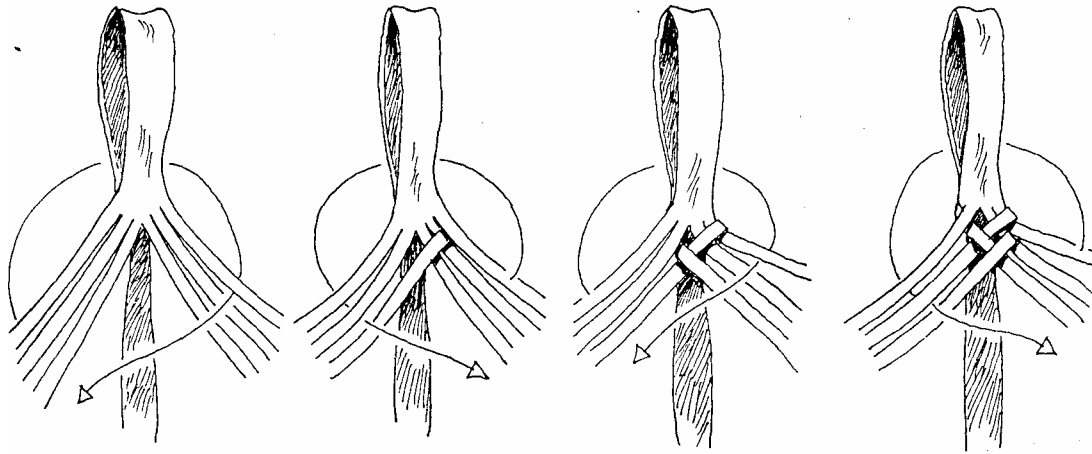

### CHANGING FROM 6 to 4

When the plaiting gets to within 100mm of the end of the short strands they are dropped into the centre of the whip as shown and the sequence changes to 4 plait for the rest of the whip.

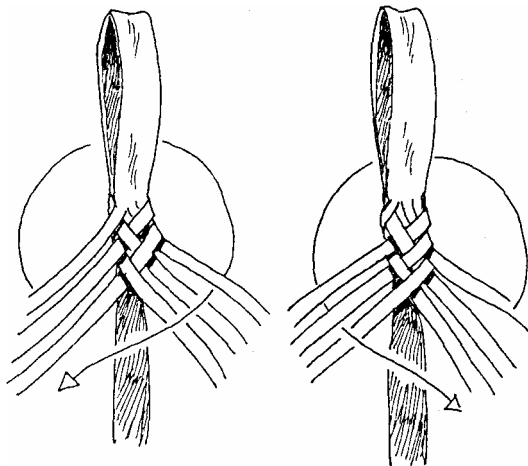

Make sure that the short ends are properly thinned down, and take care doing this change-over so that the whip keeps a smooth taper all the way.

It is not necessary to wait until the short ends are almost used up before dropping them. If the whip begins to look too thick they may be dropped at any time.

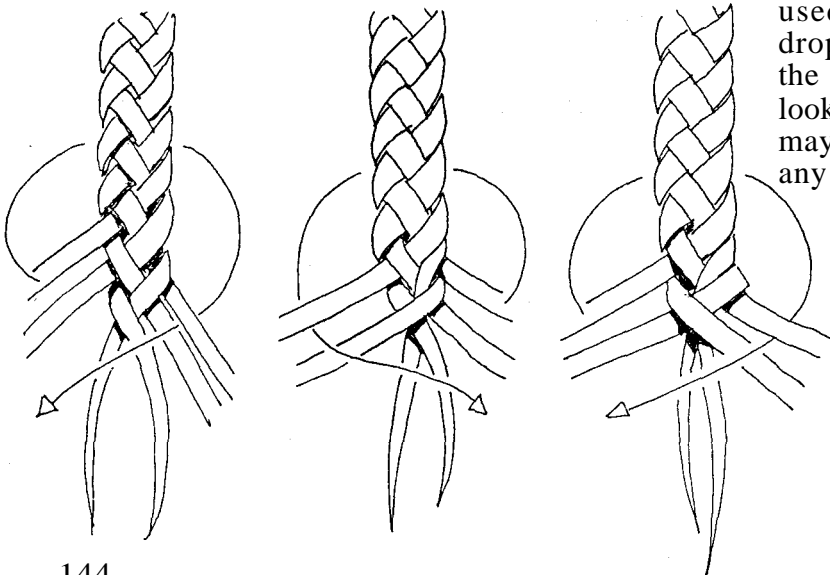

# WHIPMAKING part 2

## Kangaroo hide stockwhips

Stockwhips come in two forms, the

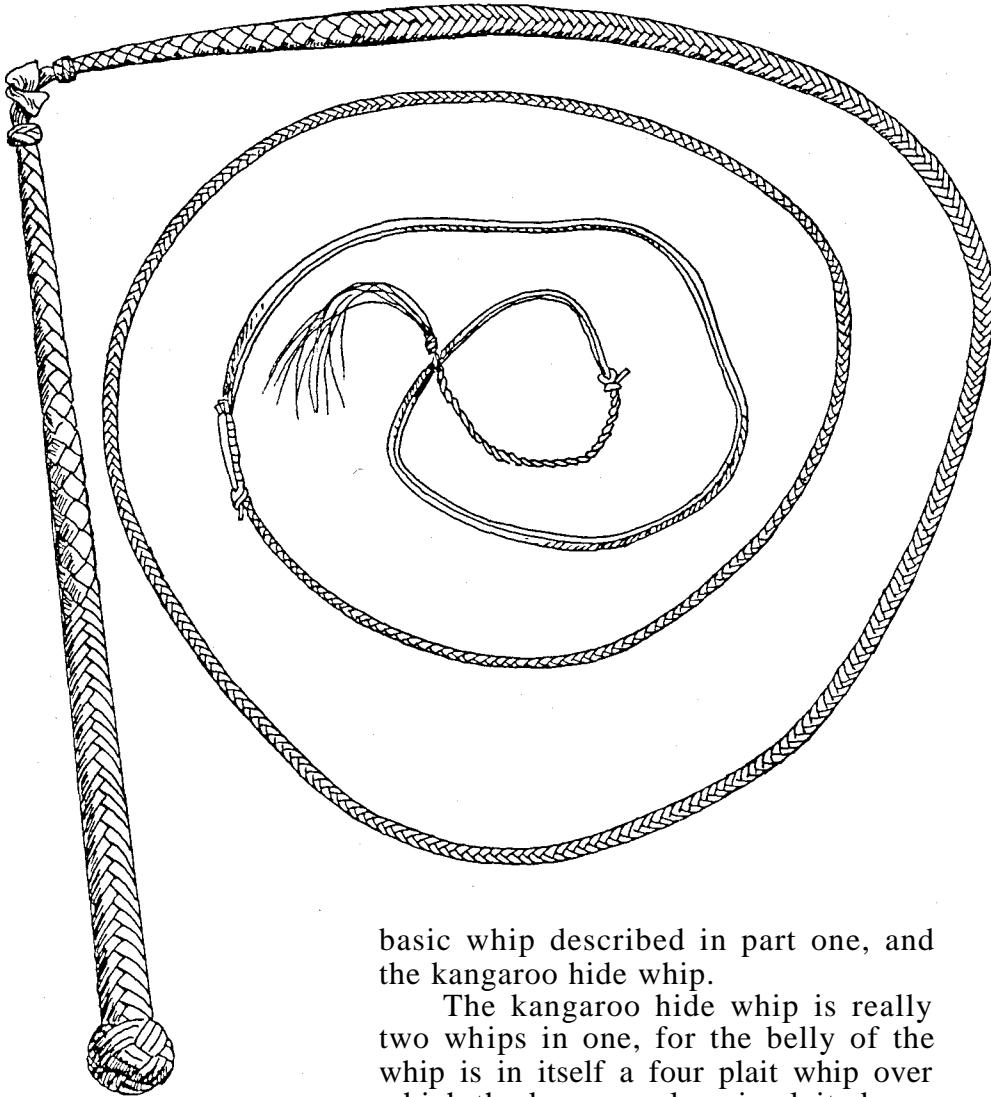

basic whip described in part one, and the kangaroo hide whip.

The kangaroo hide whip is really two whips in one, for the belly of the whip is in itself a four plait whip over which the kangaroo lace is plaited.

This section also contains instructions for plaiting a bullwhip and a snakewhip.



# Materials Needed

- A full kangaroo hide.
- A knife.
- A strand-cutter (optional).
- Mutton fat or leather dressing.
- A long strip of 3 or 4mm thick cowhide for the core.
- A long strip of thin soft leather for the bolster (optional).
- Redhide fall and nylon or horsehair cracker.
- Black waxed thread.
- 500mm of cane or timber for the handle.

Whips can be made to any desired length. In this case the instructions are for whip of 2300mm with a 600mm fall, an average sort of whip.

Whipmakers develop different techniques, and each man thinks that his method is the best. The methods described here are probably the most popular.

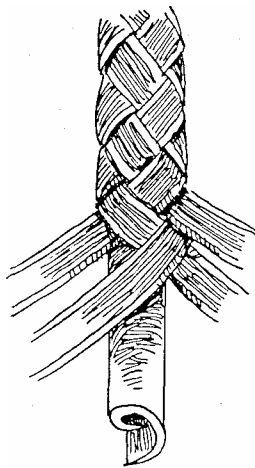

Fig.1. shows the way a plain stockwhip is often made, a four plait over a belly of rolled leather.

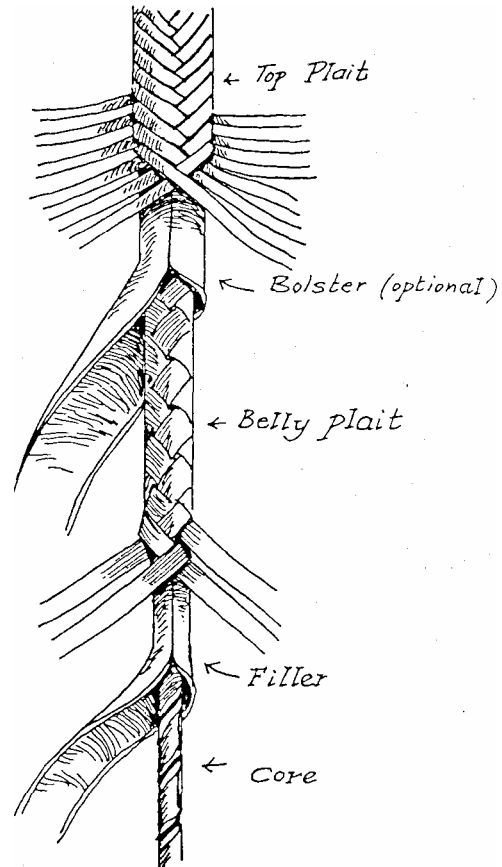
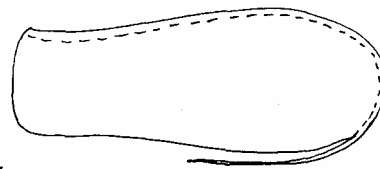

Fig.2. shows a kangaroo hide whip, which can consist of up to five layers. A whip of this type will probably take five times as long to make as a plain stockwhip, but the final result should almost be a work of art as well as a very practical whip.



THE CORE

Fig.3. The core is cut from an ordinary hide of any strong leather 3-4mm thick. Because whips are longer than hides no attempt is made to make a straight cut, the strip is simply cut by running around the outer edge of the leather.

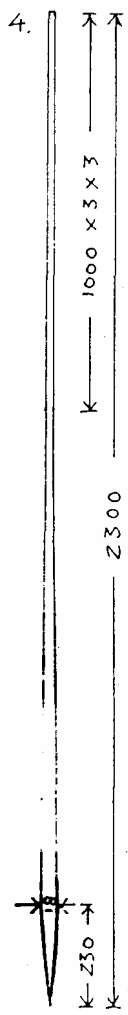

Fig.4. Cut to these dimensions, this represents the final length of the whip.

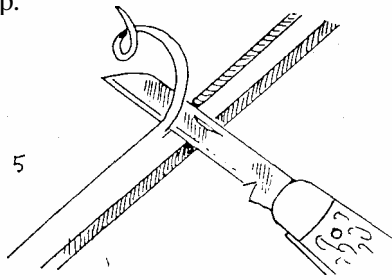
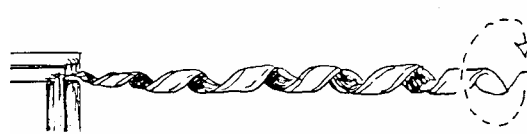

Fig.5. Very sharp knives are needed for whipmaking. The two top edges of the leather should be skived, or all four edges if the leather is thick.



Next soak the leather in water for a few minutes until it is thoroughly wet.

Fig.6. Put the end nearest the wide part into a vice, or under a weight, or tack it down. Twist it tightly until it forms a cylinder, or as close as you can get to one before it begins to kink.

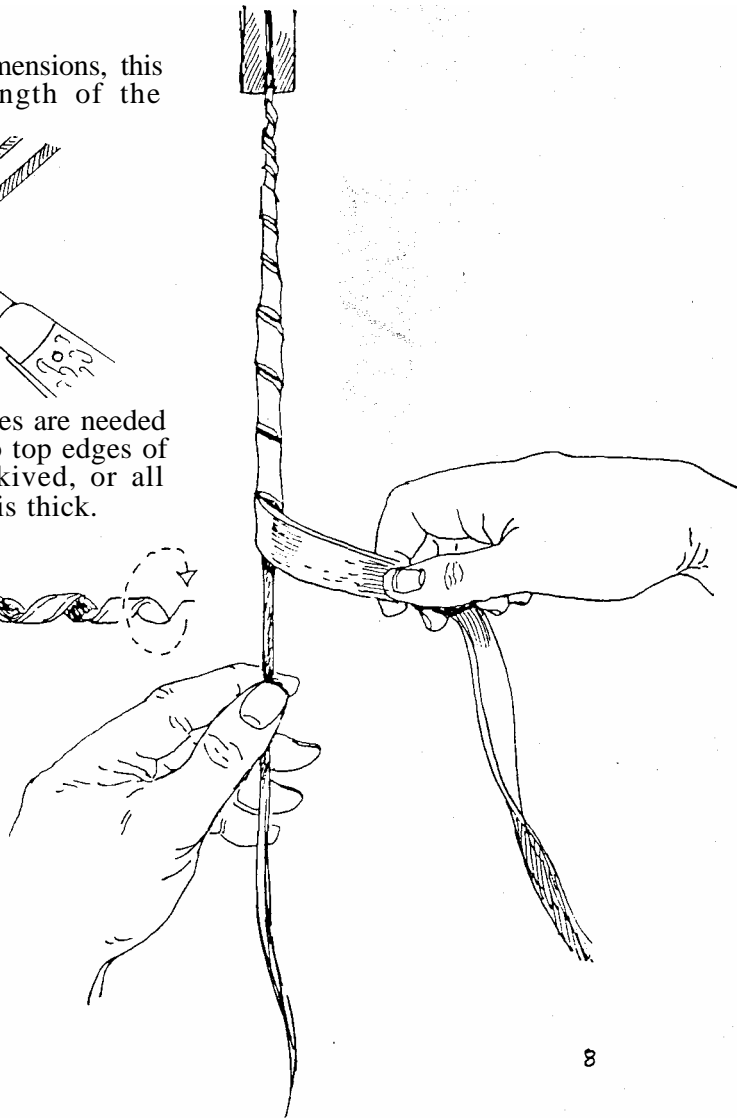
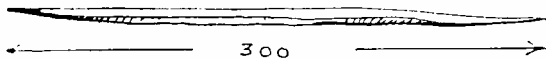

Fig.8. Both the core and the scrap of leather are held in the vice and the core is wrapped around as shown.

Fig.7. Where the leather is wide it



will twist into a hollow tube. This does not matter, but some people prefer to have a solid core.

This can be done by cutting a scrap of leather to about 300mm long to go inside the tube.

In the old days whips were often weighted with lead at the handle end. A small cotton tube filled with lead shot would be inserted into the tube instead of the scrap of leather.



Fig.9. The wrapping is only done for the first 300mm. The rest of the leather will twist up like this.

At this stage the core may look rather rough, but later it will be rolled smooth and should then look like fig.10.

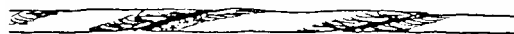

10

Fig.11. In theory the twisting of the leather should shorten the core,

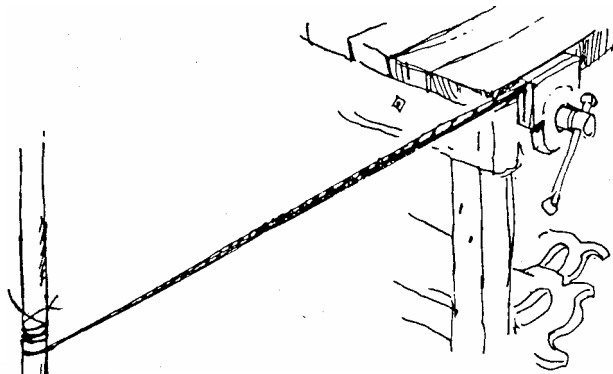

11 but in practise the wet leather will also stretch while the twisting is being done, and so end up at its original length.

It is now wrapped around something and left to dry.

Fig. 12. When dry it is rolled firmly under a board. In our business we use a big cement paving slab as a base and a board about 500x100x15.

A cement floor can be used, or a strong bench. Sometimes a lot of force is needed to get a good even roll.

It may be necessary to slightly dampen the leather if it will not roll properly.

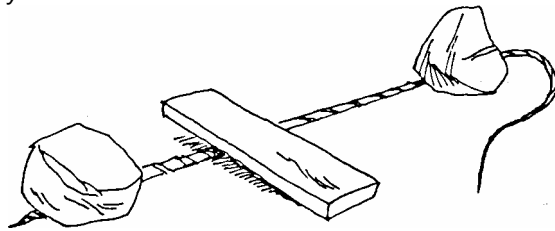

The life of a whip will depend upon regular oiling, and this should start right from the beginning.

Use leather dressing of any type, or even mutton fat, thoroughly oil the core and roll it again.

When rolling the core put some sort of weights on it so that it will not unwind.

Once properly rolled it will remain in this form permanently.

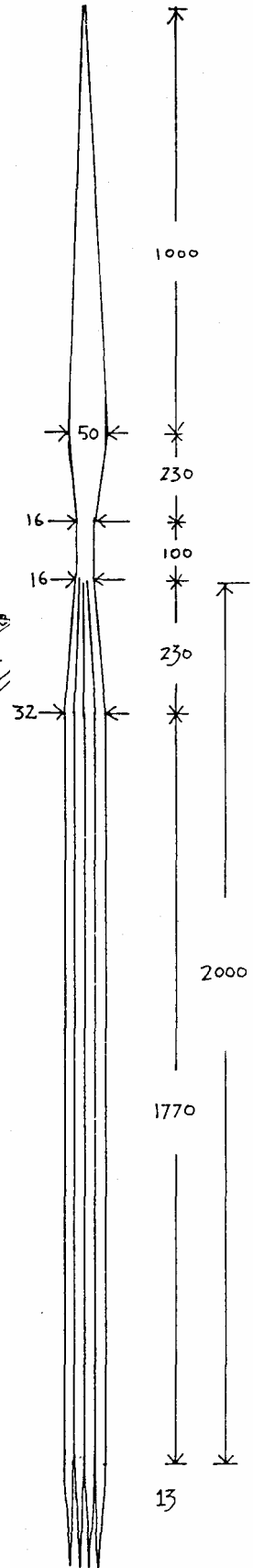

## THE FILLER AND BELLY PLAIT

Fig. 13. The filler and the belly plait are cut from one single strip of kangaroo. The method of cutting out the kangaroo hide is illustrated further on.

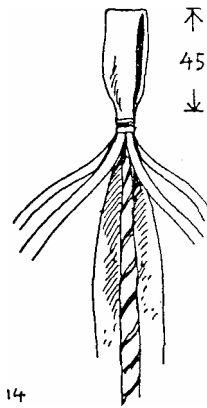
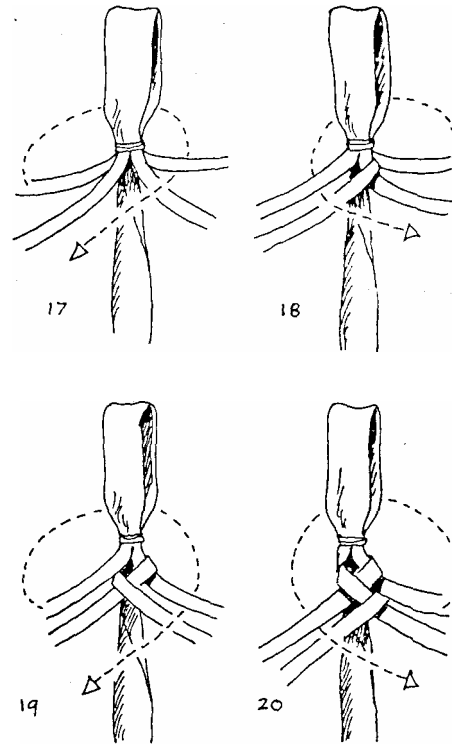

Fig. 14. The kangaroo hide is now tied to the core. The loop at the top will be part of the keeper of the whip.



Figs 17-20. A four plait is now worked over the filler.

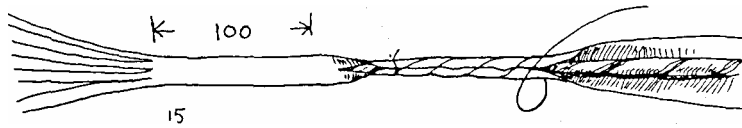

Fig. 15. Professional whipmakers often omit this step and simply fold the filler around the core as they are doing the plaiting.

Beginners will find it more convenient to use a scrap of cotton to tie the filler up before beginning to plait.

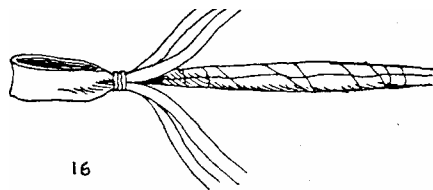

Fig.16. With the filler in place around the belly plaiting can now begin.



Fig.21. When all the strands have been used up the ends are tapered and thinned down if necessary, and then tied down with a scrap of thread.

Make sure to get a smooth line when doing this, abrupt changes in outline will show up on the finished whip.

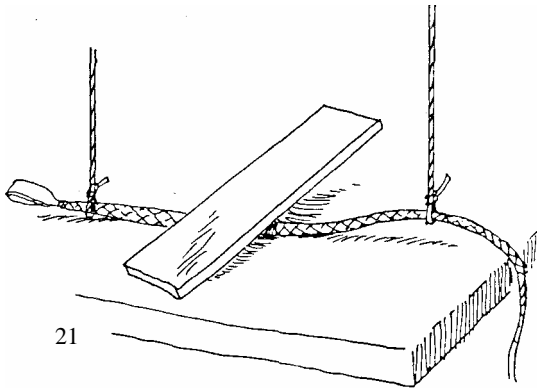
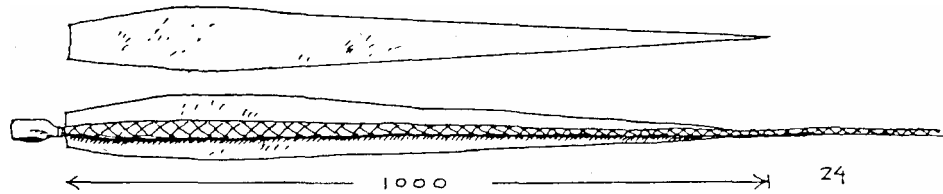

Fig.21. The completed belly is rolled to make it smooth and even. At every stage in making a whip there is some rolling to do.

If at any point you find a bad lump or a thin part then it must be remedied before going on to the next stage.

The whip will thrash about when being rolled, and knock almost everything off the bench. One way to stop this is to hang down a couple of lengths of cord. The whip can easily slip through the loops in the cord, and they will help restrain it.

other job.

A bolster is only used if it is felt to be necessary. Many whipmakers prefer to do all their shaping when forming the belly and not use a bolster.

The bolster is of the shape shown, and about a metre long.

Fig.25. It can be formed around the belly as plaiting progresses, but it is more convenient to tie it on beforehand.

Use dark thread and dark leather, as light colours will be very obvious if there are any small gaps in your final plaiting.

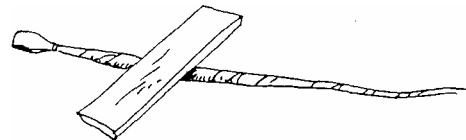

Fig.26. Once more roll the whip, and make sure that there are no wrinkles or lumps.

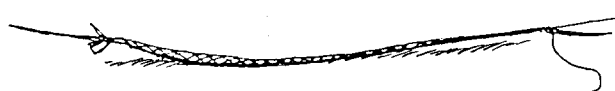

Fig.23. When rolling a whip on the floor the ends can be tied to keep the whip in the right place.

#### THE BOLSTER

Fig.24. A strip of soft leather called a bolster is used if you wish to build up the thickness of the whip.

For extra thick whips more than one thickness can be used. Soft, thin leather is best for the job, and whipmakers often take this as the opportunity to use up flanky pieces of leather that are not suitable for any

#### THE TOP PLAIT

The top plait is the slowest and most complex part of the job. Here whipmakers show their skill and knowledge, and the expert whipmaker can introduce all sorts of fancy plaiting patterns.

However here I am including only two sound, basic plaits that are easy to remember and work.

The whip begins with an over-under-over sequence that is sometimes called a diamond pattern and then changes to a herringbone pattern. This continues down the whip even though the number of strands diminish.

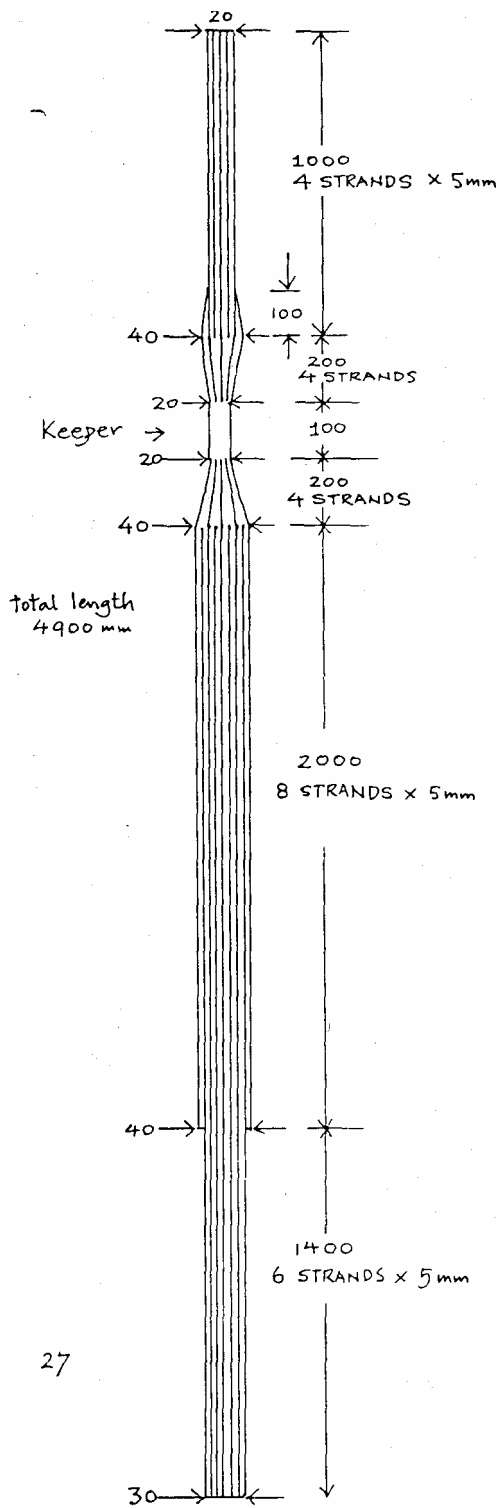

The cutting out of the strands would be much easier if kangaroos were five metres long, but as they are not special techniques have to be used.

There are a number of ways to cut out the 'set' as this part of the work is known.

The great advantage of this method is that the keeper can never be pulled loose, as it is permanently locked into place.

The keeper is the 100mm section shown in the upper half.

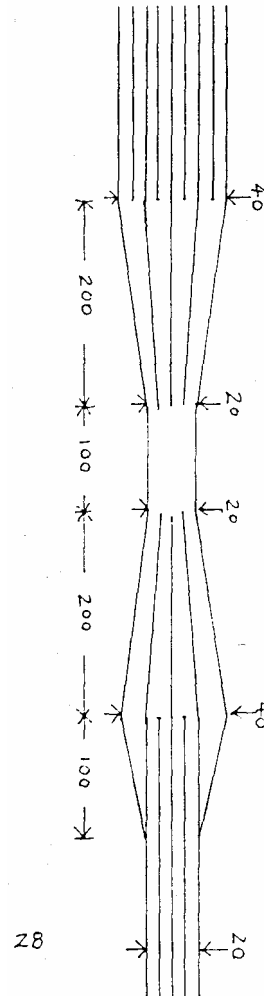

Fig.28. This is a close-up of the keeper section. For the sake of clarity it has been drawn with sharp angles, but when cutting out curve these.

There are two quite different approaches to cutting a set. The first method is to taper the strands along their entire length. This calls for great skill, and is not recommended for the beginner.

The second method uses strands of uniform length for almost the whole length, except for a short section near the keeper.

With the tapered strands the entire whip can be done with the minimum number of strands in the hand.

With the second method a larger number of strands have to be handled at the beginning of the job, but these are gradually reduced as the job progresses.

The hide is first trimmed to a

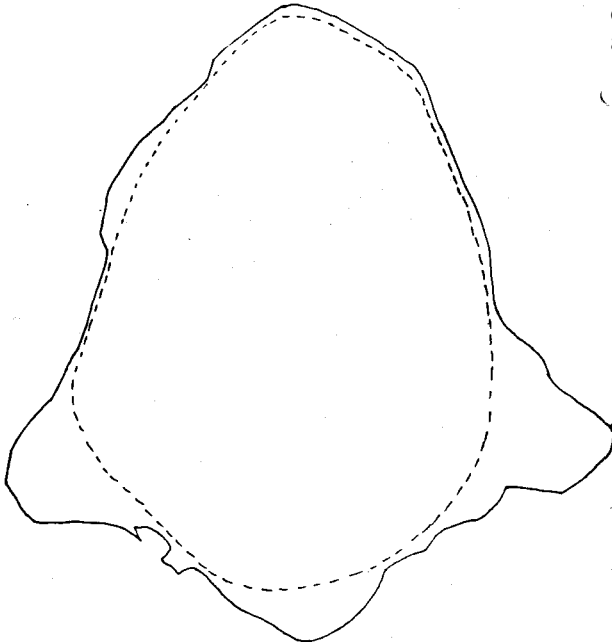

smooth shape. When cutting strands for belt making we trim to a full circle (see the section 'Stockmen's Plaited Belts'), but for whipmaking this is of no advantage.

The scraps can be used for small jobs, and short lengths of lace can be cut from them for such things as the Turk's-heads that go on the keeper end of the whip.

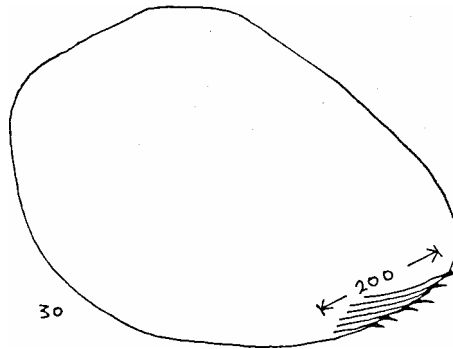

Fig.30. Begin by cutting out 6 strands, each 5mm wide and 1400mm long.

As racing people, know, the inside track is the shortest, and so the inside strands will be too short unless some adjustment is made.

Begin by spacing the start of the outside and inside strands 200mm apart.

Although most of the cutting can be done with a strand cutter, there is a section on each side of the keeper that must be cut by hand. This is the section where the eight strands become four, and are tapered.

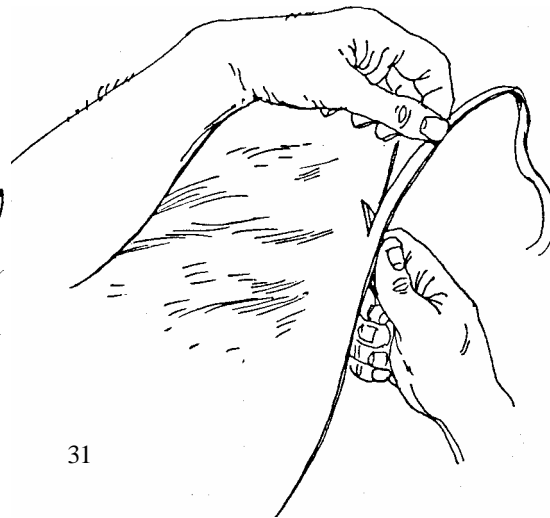
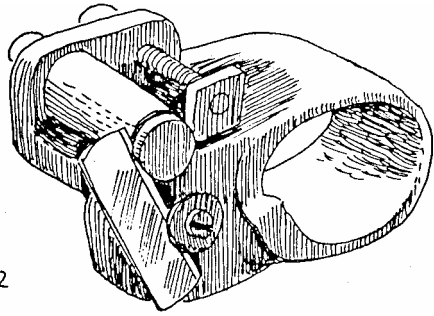

Fig.31. There are various ways to cut strands, and some are illustrated in the section on plaited belts. The method shown here is favoured by some experienced plaiters.

It requires skill, steady hands and a very sharp knife to cut strands in this way.



32

Fig.32. This is the best type of strand cutter. It is a small iron tool fitted with a blade, and it fits over the thumb.

These cutters are distributed by the stockmen's outfitters, R.M.Williams, and any leather shop should be able to order one in.

They come with their own blades, but as these become blunt ordinary razor blades can be used.

Fig.32. A homemade strand cutter does not take long to make. The one in the sketches was put together in less than ten minutes. It is not as easy to use as the R.M.Williams one, but it will do the job.

Three scraps of timber are put together as shown, dimensions do not matter.

The smallest scrap is nailed to the largest to stop the razor blade from moving backwards.

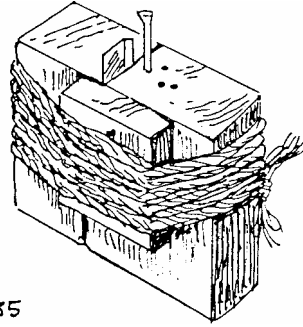

35

Fig.35. The blade is put between the two pieces of timber and they are tied together.

A small nail acts as a distance guide.

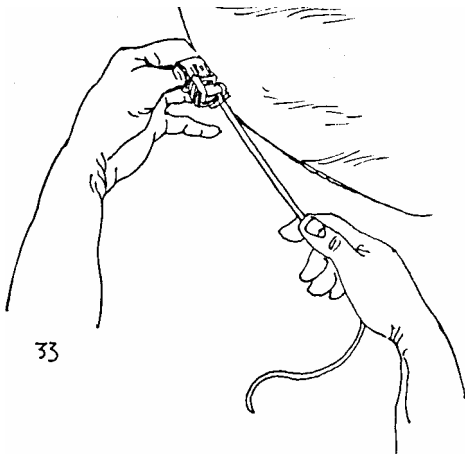

33

Fig.33. The cutter is held like this. Some people also use it on one of their fingers

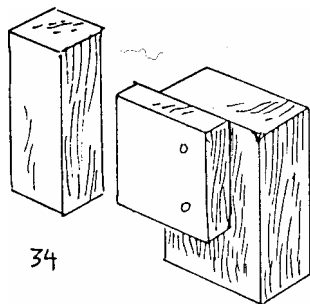

34

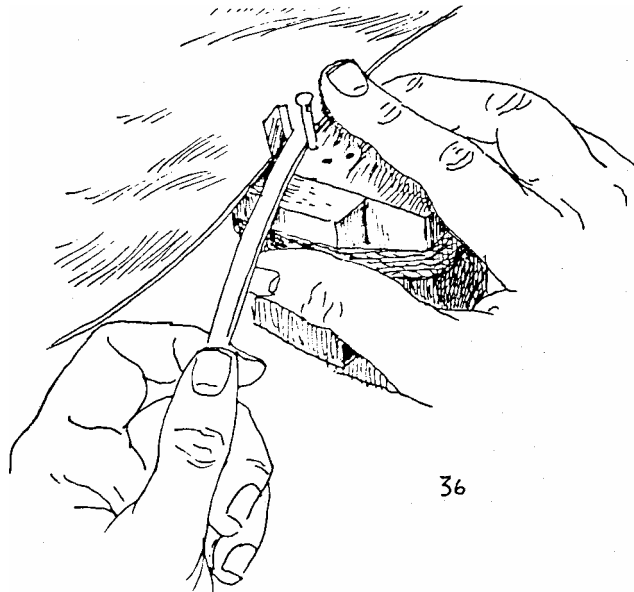

36

Fig.36. The cutter is used as shown. The first finger of the right hand prevents the leather from rising up.



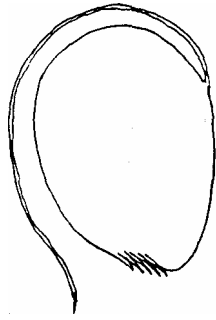

Fig.37. Cut out the first strand to 1400mm.

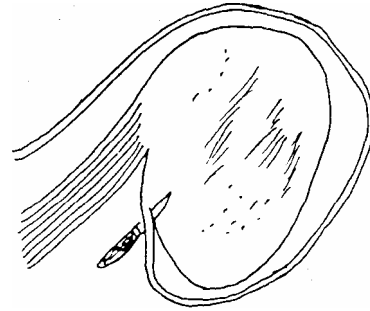

Fig.40. The eight strands go for 2000mm. As the hide is by now probably less than this distance in circumference you may find yourself in this position before you have cut the full distance.

Stop cutting this strand and cut all the other strands around to the same point.

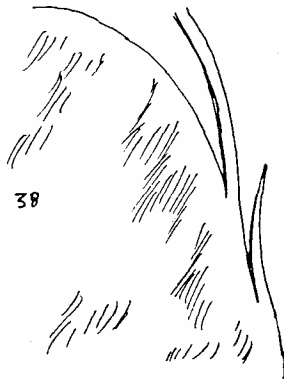

Fig.38. Begin a new strand, but only cut it for about 50mm.

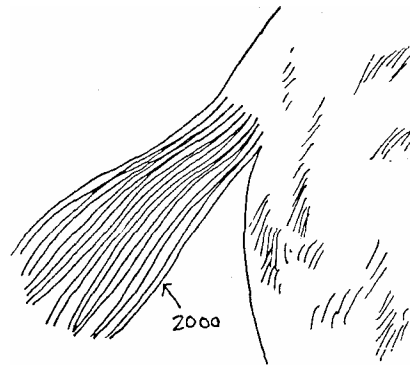

Fig.41. You can now continue until the full 2000mm has been cut.

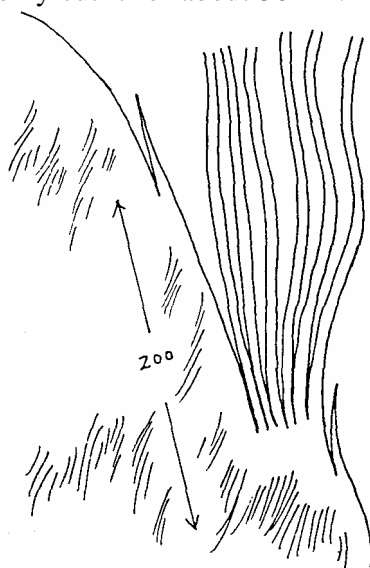

Fig.39. Cut out the remaining five strands.

200mm back from the 50mm cut make a second cut. These marks the start of new strands, so you will now be cutting eight strands.

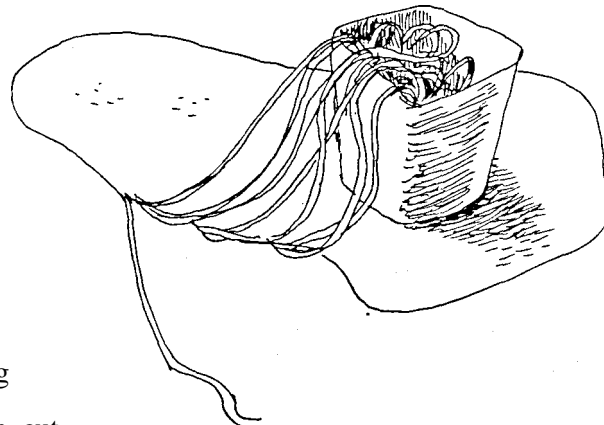
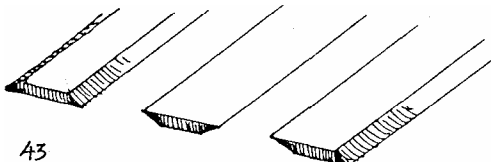

Fig.42. To avoid lace tangling around the feet I put a container on the skin and place the lace in that.



43

Fig.43. When using a heavy hide some whipmakers like to skive the edges, as this makes for a smooth finish.

There are three ways to do this, the first is the most common. Harry, who used to make whips for our saddlery business, skived his strands on the underside, but this is not a common technique.

Another less common technique is to skive the top on one side and the bottom on the other.

I prefer not to skive at all, but rather to select a hide of just the right thickness.

#### THE TOP PLAIT

#### GREASING THE STRANDS

Most plaiters consider that a tighter whip can be made if the strands are first greased.

In the bush mutton fat is the usual standby, but we prefer to use one of the leather dressings such as Coacholine, Jay-el, Gee-wy or Dubbin.

I also make up my own dressing by melting together some beeswax, neatsfoot oil and fat.

Use enough of each to make a firm, workable paste when it cools. Be careful with the fat as too much in the mix makes it very slippery to handle when plaiting (though it later sinks into the leather).

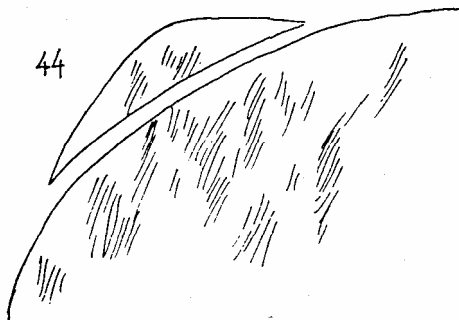

44

Fig.44. As cutting continues the hide will develop sharp corners and it will be awkward to cut around them. Trim them off from time to time.

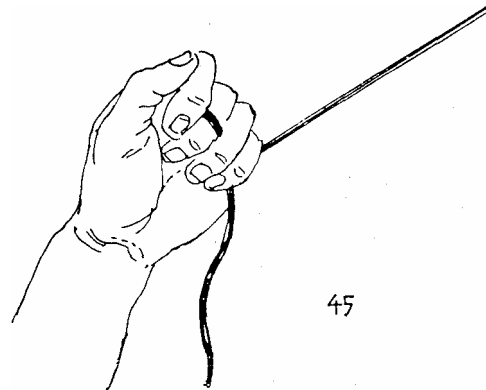

45

Fig.45. Whatever is used the strands will be greasy, and it may be necessary to wrap them around the finger in order to get a good purchase when plaiting.

As well as greasing the strands another secret for getting a good tight job is to pull each strand tight before you begin its next plaiting sequence.

Many beginners tend to only pull the strand tight after they have finished the sequence.

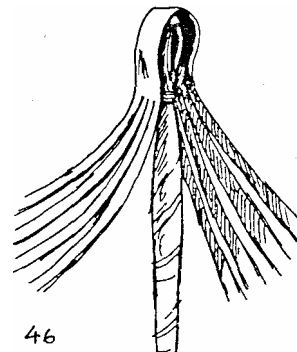

46

Fig.46. The greased set is now placed over the belly, which should also be well greased.

Put plenty of dressing around the keeper, as this will be hard to grease once it is attached to the handle.

Note that the keeper will now have two layers of leather, and this will add to the life of the whip.

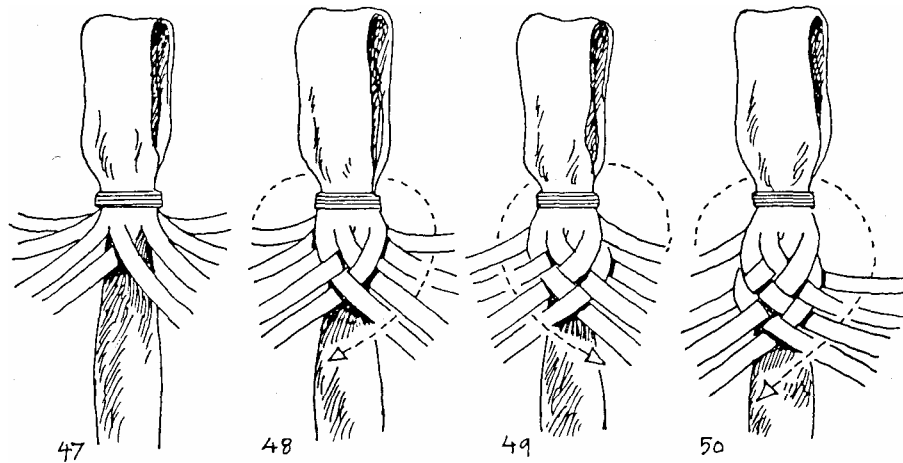

Figs 47-50. The set is tied onto the belly and plaiting begins. First the strands are arranged as shown in figs 47-8, then the plaiting sequence begins. This is shown by the dotted lines.

There is in fact another way to do the 8 plait that is faster and easier

than this, and it is illustrated at the back of the section for the benefit of the lazy, (page 172).

However whipmakers generally consider that this is the best plait to begin this short section of whip, and it also provides a nice contrast to the pattern that follows.

---



---

### AVOIDING TANGLES

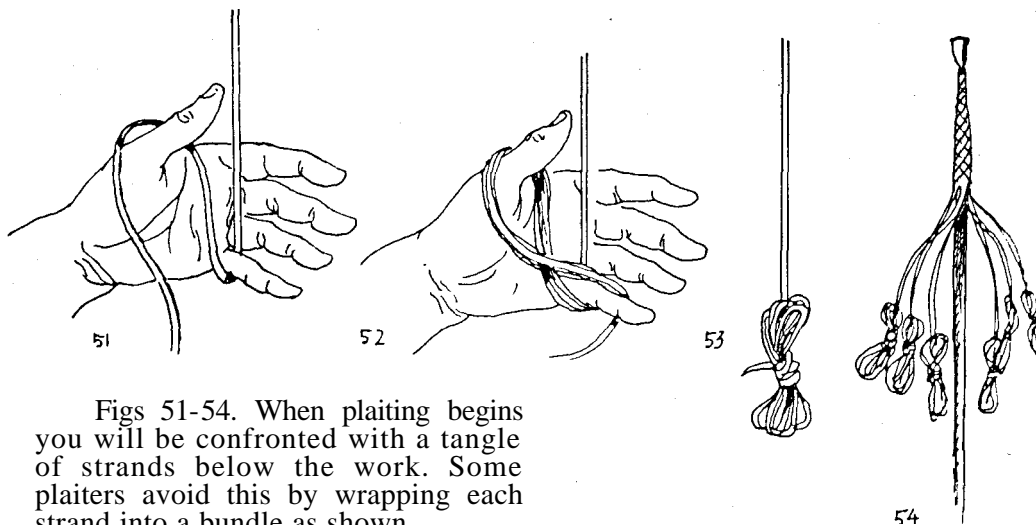

Figs 51-54. When plaiting begins you will be confronted with a tangle of strands below the work. Some plaiters avoid this by wrapping each strand into a bundle as shown.

By pulling downwards on the bundles more lace is freed as required.

I find the bundles a mixed blessing, and often prefer to work without them, but this can lead to terrible tangles.

The secret to avoiding them is to not try and continually untangle all the strands, but to simply pull free of the bundle the strand you are about to use. This alone is enough to stop a tangle developing.

Fig.55. When the short strands have been almost used up they are put down out of the way as shown.

At this stage the plaiting should have reached the split strands. If for some reason the splits are not all up to the plaited section now is the time to pause and slit them up a bit more.

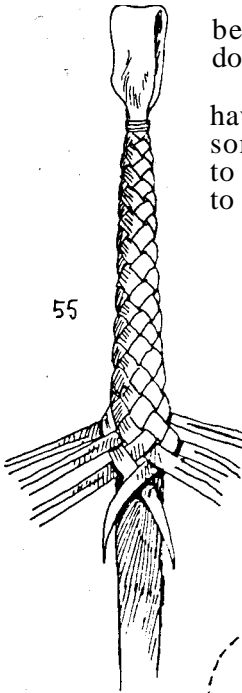

55

Fig.56. There should now be 12 free strands. The next plaiting sequence is very simple, the top strand is taken around as shown by the dotted line.

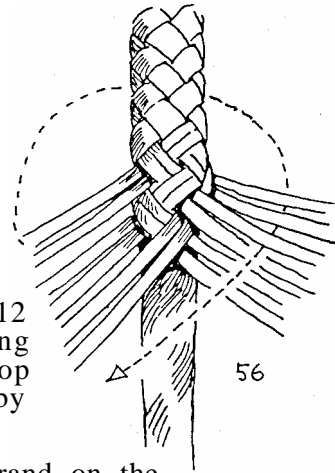

56

Fig.57. The top strand on the opposite side is brought around as shown, and so the sequence goes.

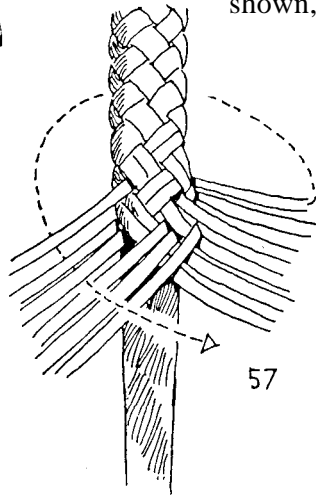

57

Fig.58. Interruptions can be a problem when plaiting, as the strands from one side can get confused with the other. If the sides are tied up as shown this problem can be avoided.

With a little practise this simple knot can be tied with one hand. The finished knots are shown in fig.59.

A simple pull on the end of the strands will release the knot ready to continue work.

As you may have forgotten which side you should begin have a look at the job. The side on which the lower strands comes out halfway down the strands is the last one to have been done.

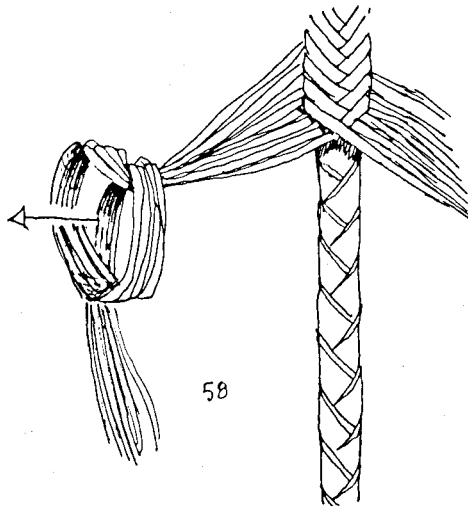

58

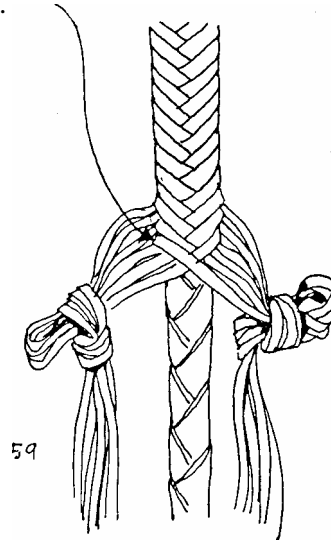

59

## BROKEN STRANDS

Sooner or later a strand will break, or you may find that you are running short on a number of strands. There are various ways to add on extra strands.

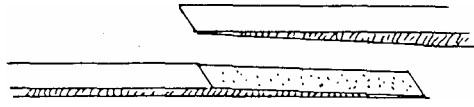

This is the neatest way, but it also takes some time. Both ends of the lace are skived back for as long as possible, 25-40mm is good.

The ends are then glued together with Kwik Grip, Contact Cement or some other similar glue.

When done properly the join will be almost undetectable.

Wipe all the grease off the strand before skiving in order to get a clean surface for the glue.

## JOINING WITHOUT GLUE

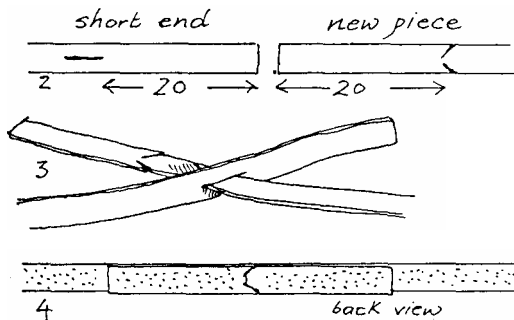

Figs 2-4. It is possible to join the strands without glueing them if you can ensure that the join will be hidden by an overlapping strand in the plait.

This first method is the neatest. Cut a small slit in the short end of the lace, and two angled cuts in the new piece.

Push the new piece through the old one as shown in fig.3, and then pull them together. The angled cuts will act like arrows and hold the pieces together.

The idea of having a 20mm overlap on the pieces is so that when the lace is plaited in the weakness of the lace at this point will be minimized.



Fig.5. The completed join from the front.

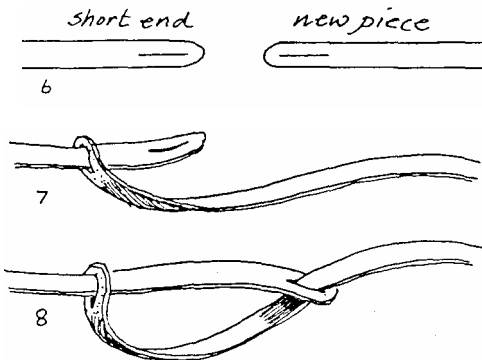

Figs 6-8. There is a simpler method of making a joint without glue by simply putting a slit in each end and joining them as shown.



Fig.9. This type of join is easy to remember, and is stronger than the previous one, but does not look as neat.

## A FASTER JOIN

This is the fastest way to introduce a new section of lace to the job. Is only suitable for use when using thin lace on the thicker section of tightly

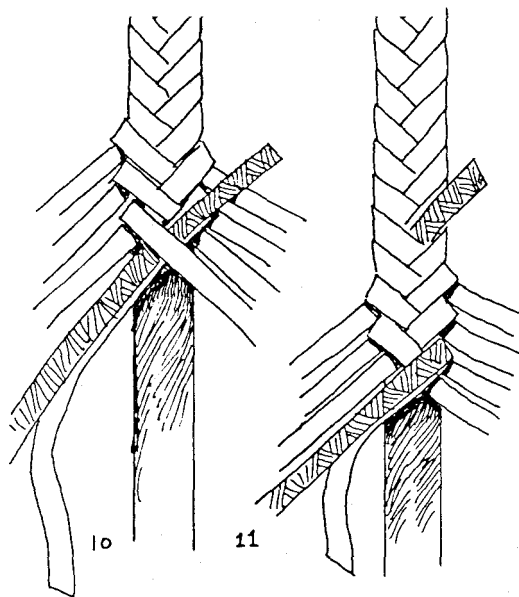

plaited whips. If used with thick lace on the lower, narrow part of the whip the ends may work loose after a time.

just goes out of sight. Drop the short end, pick up the new strand and continue plaiting.

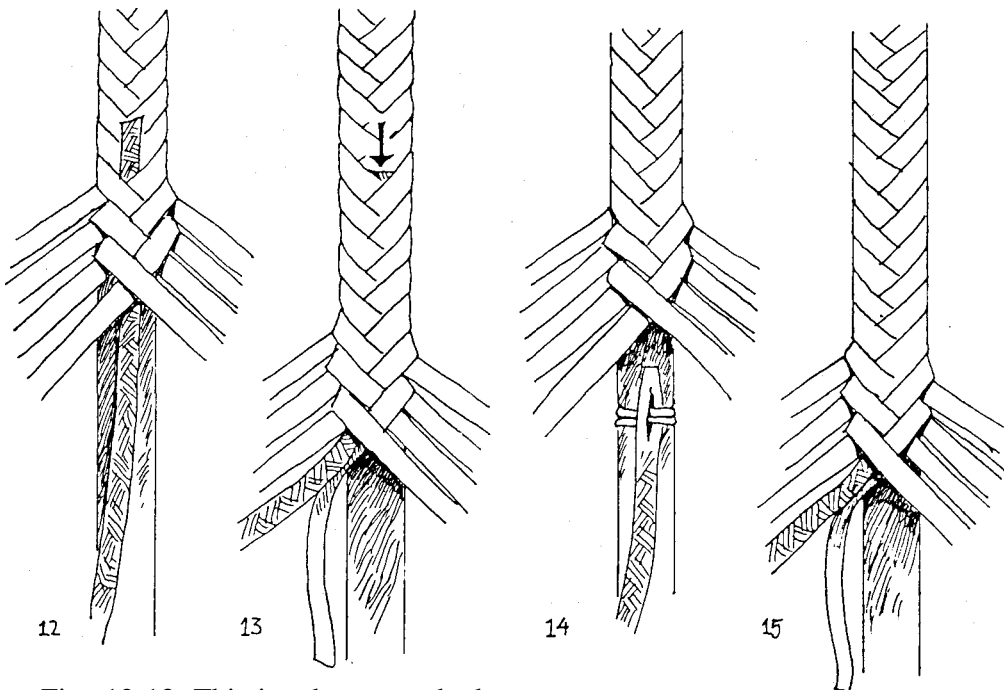

Figs 12-13. This is a better method of adding in a new strand. Push it up into place as shown, and then continue plaiting until you are sure that it is firmly in position.

Pull down carefully until the end

Figs 14-15. It is also possible to tie new strands to the belly. Continue plaiting until the new strand feels quite firmly in place, then drop the short end and pick up the new strand.

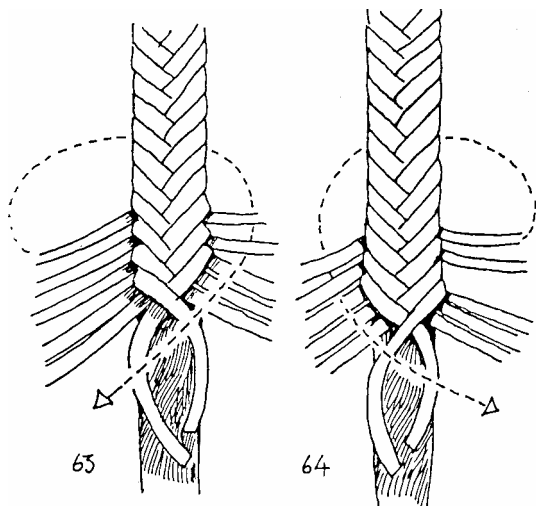

#### CHANGING FROM 12 TO 10 PLAITS

Figs 63-64. The 12 plait continues down the tapering shape of the whip until it begins to bunch up due to the whip becoming narrower.

When this happens it is time to drop a couple of strands. The strands can be left uncut, or trimmed as shown.

The plaiting sequence now changes slightly. Instead of the strands passing through under the third strand from the top, they now go under the second strand.

The short strands are soon hidden from sight as plaiting continues in this sequence.

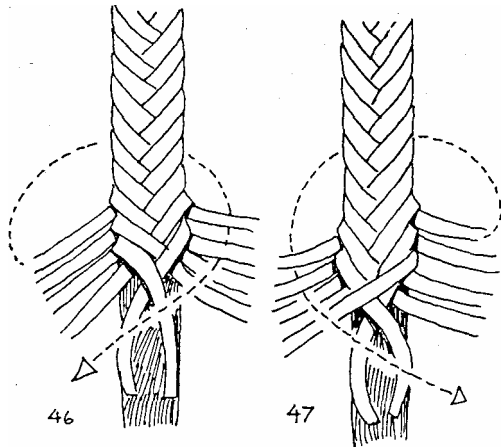

### CHANGING FROM 10 TO 8 PLAITS

Figs 46-47. In time you will come to the end of the shorter strands, or the plaiting will again have begun to bunch up, and it will be time to drop two more strands.

This time there is no change in plaiting sequence. The short strands are simply dropped and plaiting continues, the strands still being taken under the second strand from the top.

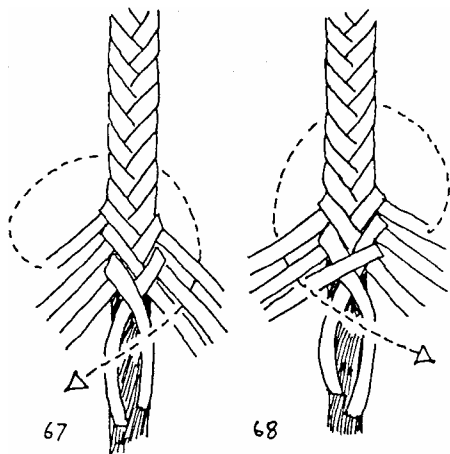

### CHANGING FROM 8 TO 6 PLAITS

Figs 67-68. This is also a simple change, the short strands are dropped and plaiting continues in the same way, the strands passing under the second strand from the top.

This six plait is taken for the remaining length of the whip.

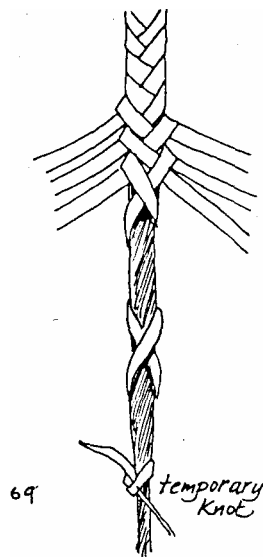

Fig.69. Sometimes, in order to avoid an abrupt change in taper, the dropped strands are left inside the whip for their full length.

In order to get them out of the way they may be wrapped as shown and held with a temporary knot, which is untied when plaiting gets almost to it.

When the end of the core is reached the plaiting is complete.

### THE FALL

The fall of the whip is usually of redhide or greenhide. If you have neither then a heavily oiled strip of the same leather that was used for the core can be used.

It can be cut to whatever length you like, but these measurements are common.

The purpose of the fall is to protect the plaited end of the whip. The very end of the whip takes the most punishment, and it is easier to replace a fall than have to replait a section of whip.

A cracker goes on the fall.

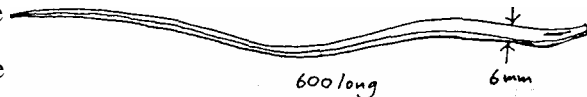
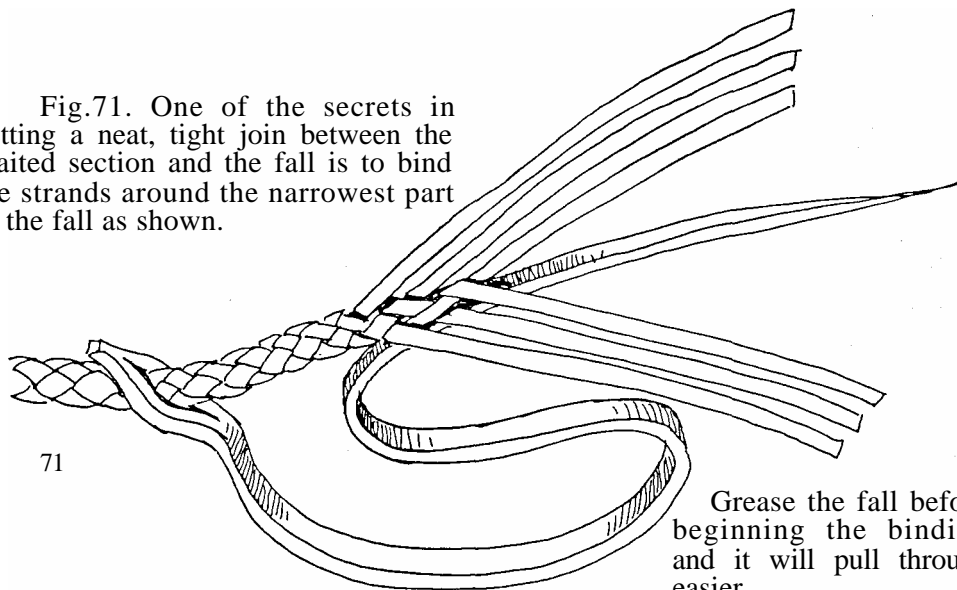
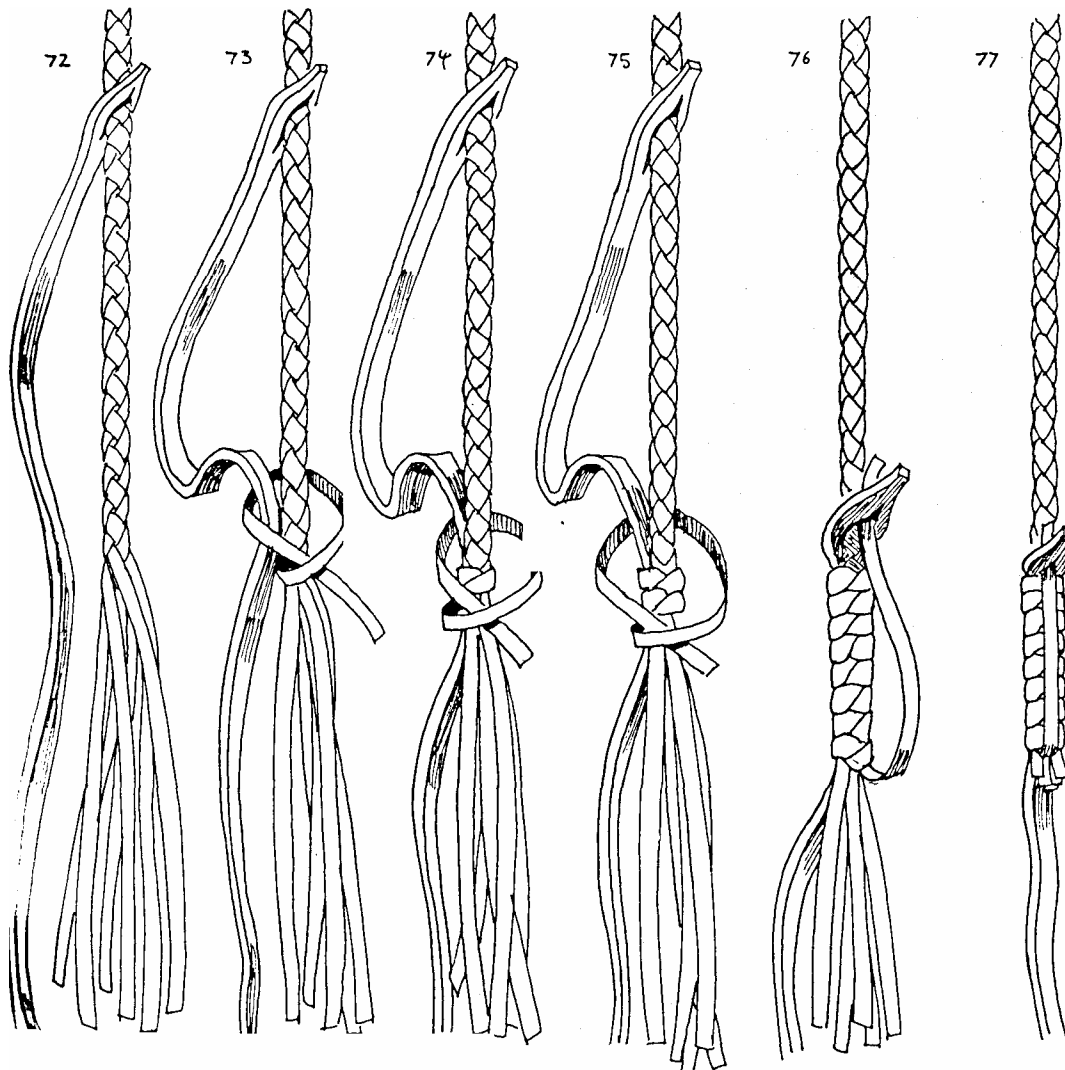

Fig.71. One of the secrets in getting a neat, tight join between the plaited section and the fall is to bind the strands around the narrowest part of the fall as shown.



71

Grease the fall before beginning the binding and it will pull through easier.



Figs 72-77. This is how the fall is attached.



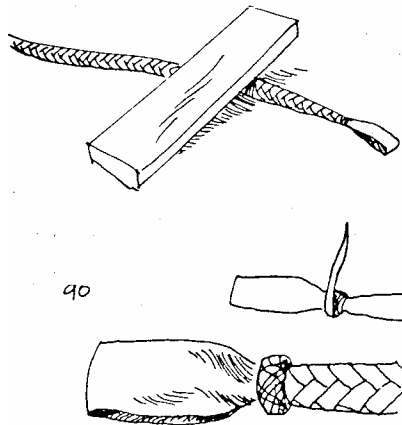

Fig.89. Now for the final roll, until the whip comes up smooth and round.

Fig.90. The final touch is a small Turk's-head to cover up the twine at the beginning of the plaiting.

This can be put on as a flat covering, or it can be raised.

Fig.90. shows how to go about raising it. A scrap of lace is wrapped around the whip, and then some thread to form a smooth shape.

The Turk's-head goes over this.

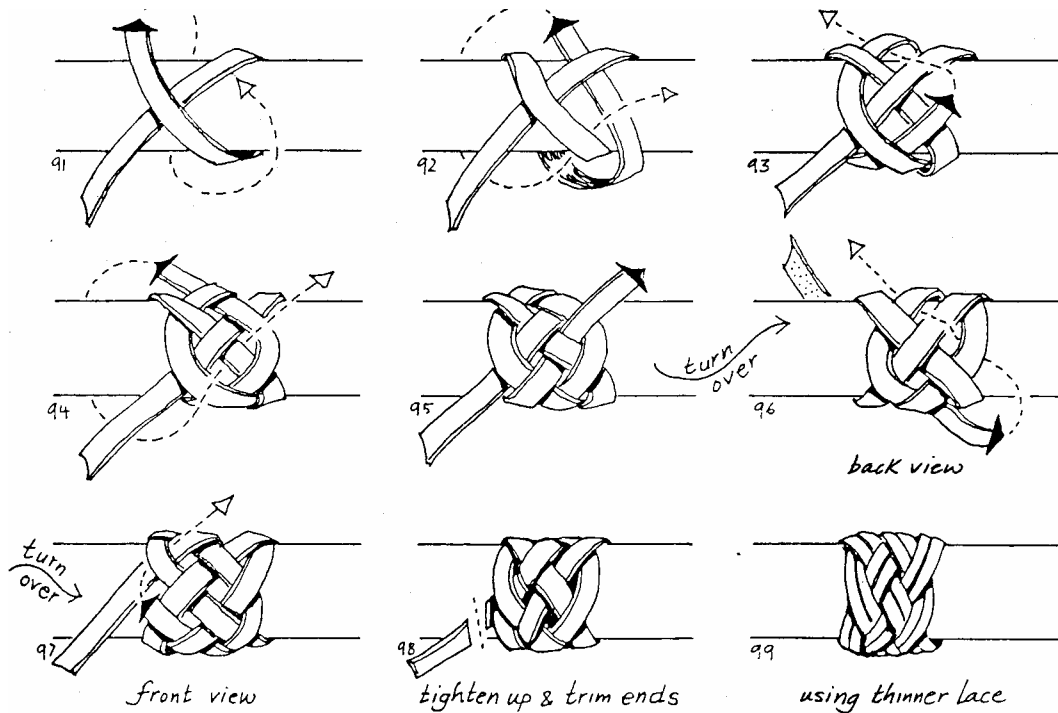

Figs 91-98. This is how the Turk's-head is formed. About 500 mm of lace will do the job.

Fig.99. It is also possible to use thinner lace and go around twice.

Fig. 100. This is how the finished knot should look.

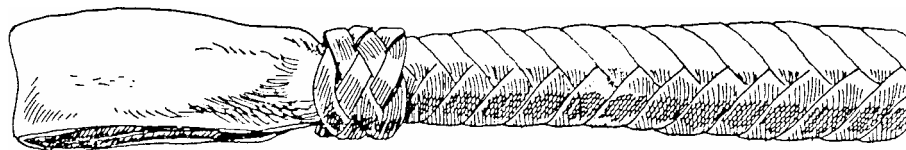

## THE HANDLE

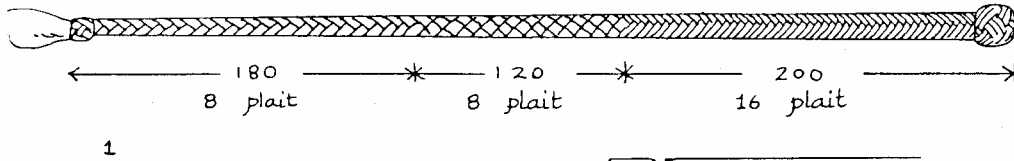

The best stockwhips have a handle that is fully plaited over. Good whips will also show a variety of plaits on the handle, for this is where the whipmaker likes to demonstrate his skill.

The one explained here is easy to do, but looks very fine with three different areas of plaiting.

The measurements given in fig.1. can be changed as desired.

### LENGTH TO CUT

See fig.7. page 25 for the cutting plan.

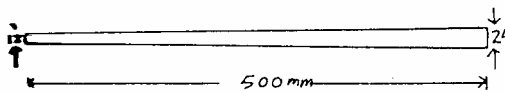
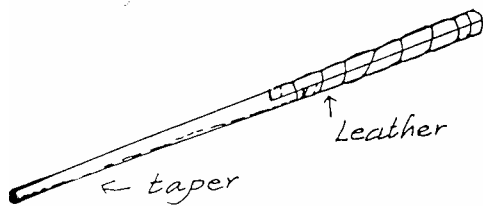

Fig.2. Select a strong piece of timber for the handle, and shape it as shown.

We usually use lawyer cane for our whips, and obtain it from the people who make and repair cane furniture, but any timber will do as long as it does not break readily.



One end of the handle is tapered.

possible to build up the shape with If the other end is not wide enough it a piece of leather.

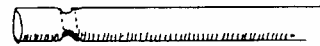

Fig. 4. Cut a small groove in the end. The strands are tied down over this part, and it helps ensure that they will remain firmly in place.

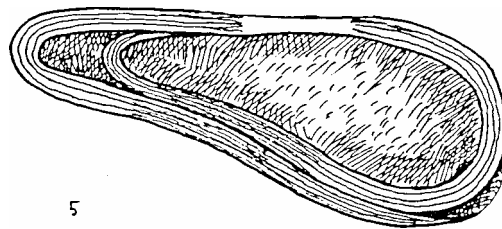
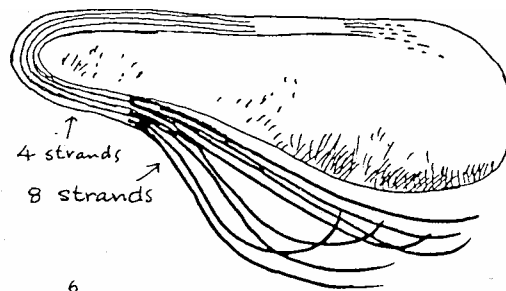

Fig.5. By this time your kangaroo hide will have become much smaller, and the set for the handle may have to be marked out somewhat as shown.

Try and avoid tight curves as they are very difficult to cut around, and the strand may not straighten out properly.

When marking out take the measurements along the inside strand as this will be the shortest one.



first, then the four strands, then the

Fig. 6. The set is cut as 8 strands keeper, 4 strands and 8 strands.

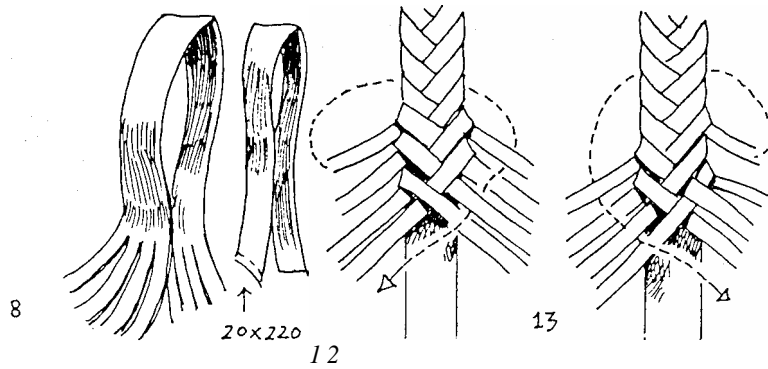
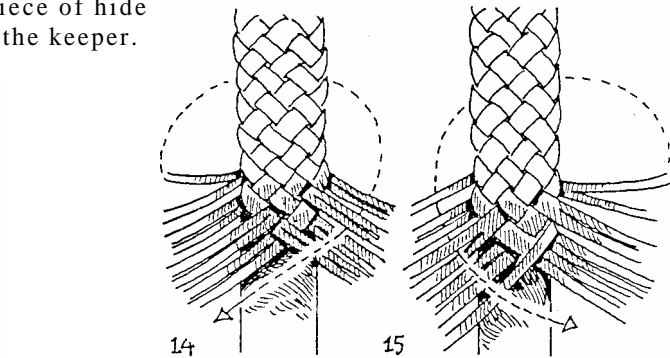
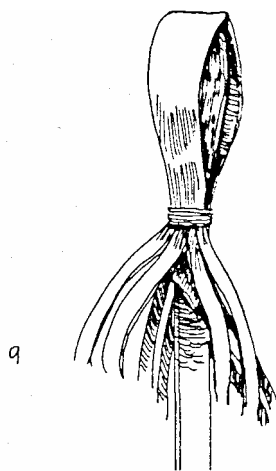

Fig.8. Cut an extra piece of hide to go as reinforcing inside the keeper.

Figs 12-13. When 180mm has been plaited change to a diamond pattern.



Figs 14-15. When the split strands are reached change back to a herringbone pattern, this time of 16 strands. This makes a finely worked section where the hand grasps the whip.

Fig.9. Tie the reinforcing piece and the keeper firmly

onto the handle.

Fig. 16. If, when the end of the handle is reached, there is excess lace left over some of it can be wrapped Figs 10-11. begin with an 8 plait in around the end to begin the herringbone pattern.

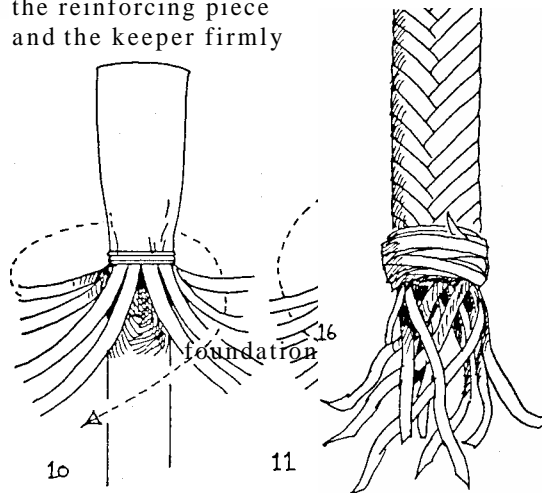

17

Fig. 17. Heavy thread or fine is used to build up the final shape of the knob. Waxed thread is best, and it should be a dark colour in case there are any small gaps in the final plaiting. Before the building up of the knob is complete it is a good idea to put three or four tacks into it as a precaution against the knob coming loose at a later stage.

Do this before the knob has been fully shaped as the tacking will tend to alter the shape of the knob.

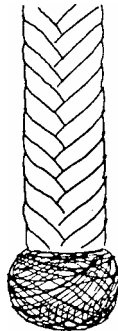

Fig.18. Continue winding on thread till a good shape has been achieved.

22

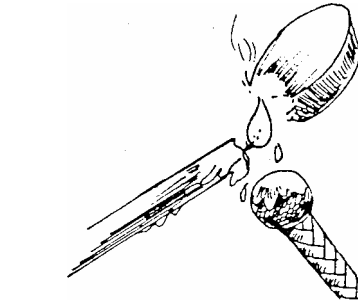
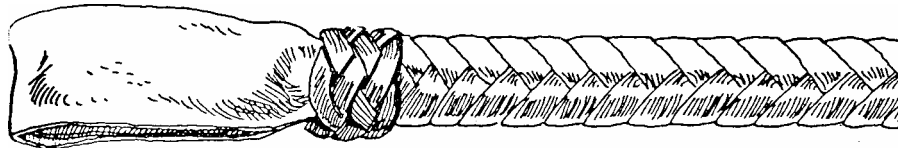
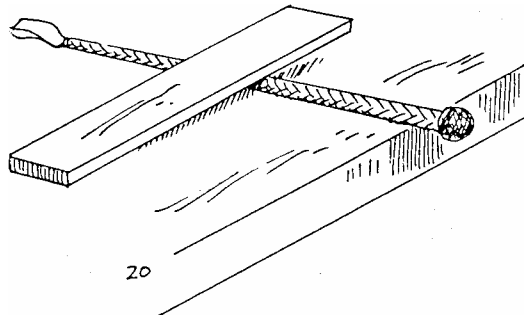

Fig. 19. This is a good idea, but not essential. Take a lump of beeswax in one hand and a lighted candle in the other and let the hot wax drip down and fill any gaps that there may be between the



The knob is hung over the edge of the bench and the handle given a good, firm rolling.

21



Fig.21. The same Turk's-head that goes on the keeper end of the whip also goes on the keeper end of the handle.

It can be put on flat, or the end can be built up with thread.

Fig.22. This is how the finished end should look.

Figs 23-32. There are two popular Turk's-heads used on whip handle knobs. This is the more complicated one.

An easier one is shown a little further on, (page 170).

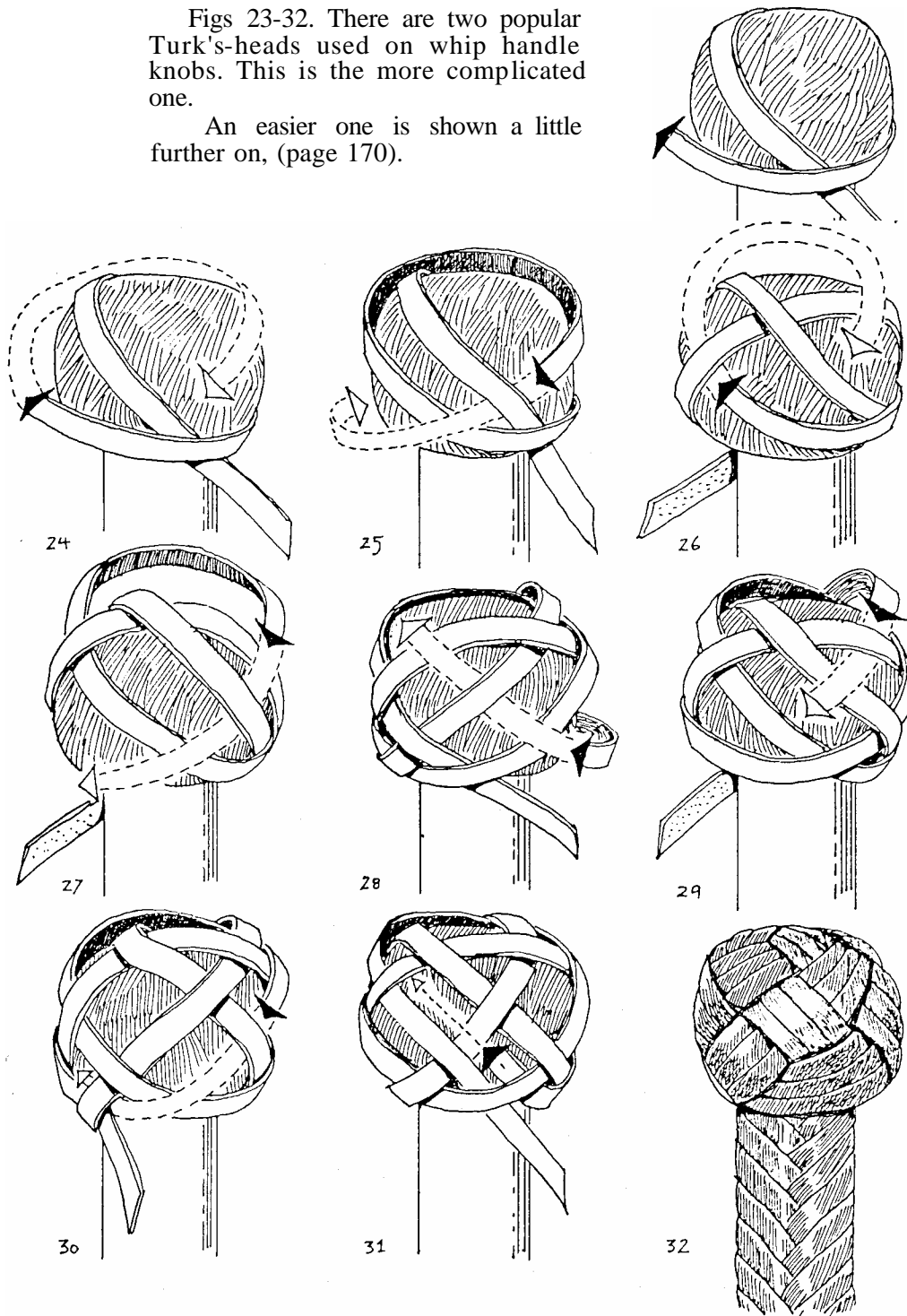

35 Fig.33. This is how the finished handle should look.

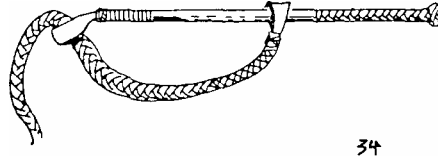

Fig.33. The handle is attached and the whip is complete.

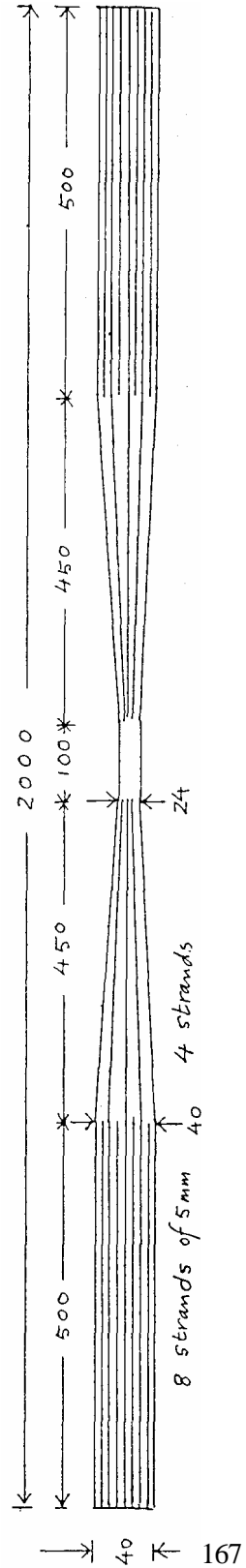

Fig.7. The measurements can only be taken as a guide, as slight differences in the thickness of the handle will cause changes.

## A HALF-PLAITED HANDLE

This type of handle is much easier and quicker to make than the previous one, and for this reason is not so highly regarded by skilled whipmakers, even though it can look very attractive.

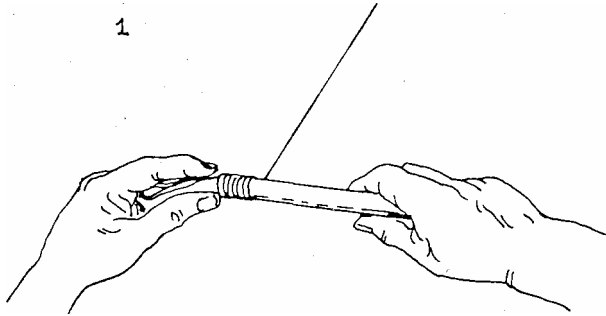

Fig. 1. A strip of heavy kangaroo hide 220x20mm is used for the keeper, or two light pieces.

The keeper is tied on with strong thread. This should be waxed to help preserve it.

In order to get a tight job one end of the thread is made firm to something and the whipmaker winds the thread on as shown, moving forward as he winds.

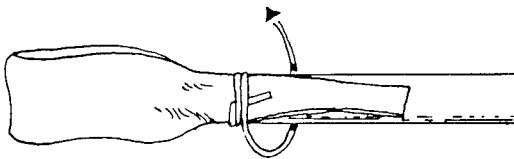

Fig. 2. Tuck one end of the thread under and begin winding.

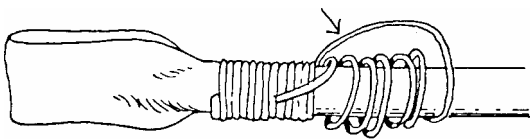

Fig. 3. When most of the winding has been done undo the thread from whatever it is tied to and cut it off with about 500mm left hanging.

Form a bridge, as shown by the arrow, and wind the thread back

towards the keeper.

Grasp the bridge at the point shown by the arrow and tightly wind it around the handle.

When all the thread has been wound on it will look like fig. 4.

Pull the end tight and cut it off flush.

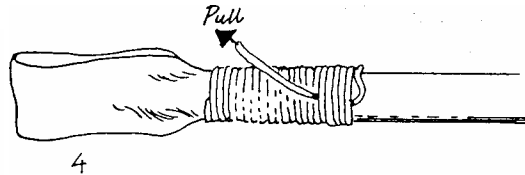

## FRENCH WHIPPING

Figs 5-9. This next part is purely for decoration. Take a length of kangaroo lace and work it as shown. It should cover all the thread below.

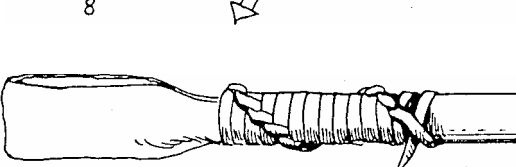
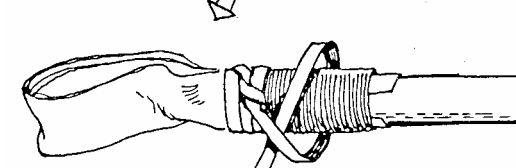
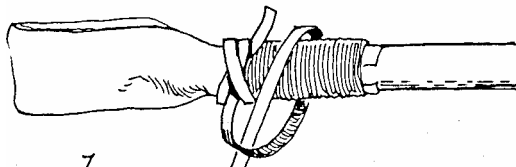
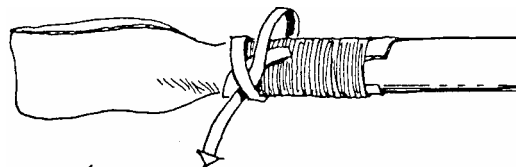
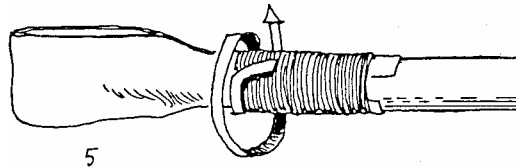

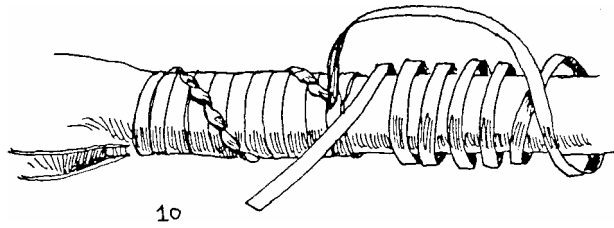

Fig. 10. The lace is finished off in the same way as the thread.

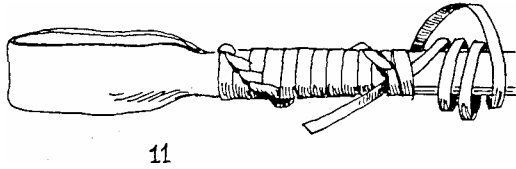

Fig. 11. The spiral pattern is lost in these few last turns.

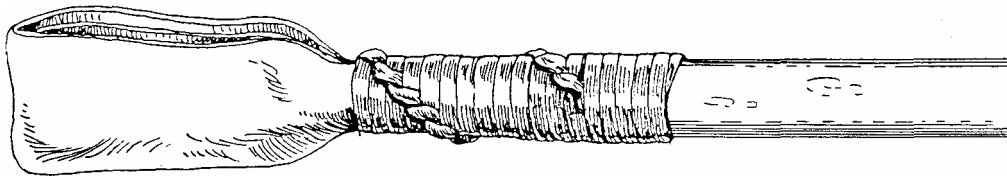

Fig. 12. There is no sign of the thread in the finished job.

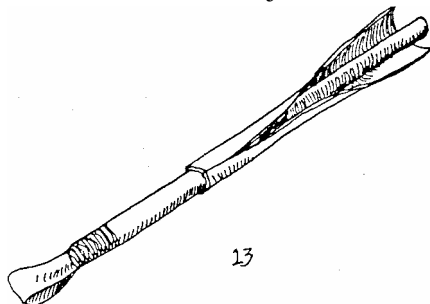

Fig. 13. Take a strip of thin leather, kangaroo is best but any leather can be used, and trim it so that it just wraps around the handle.

often use the thinner parts for this sort of work.

This can sometimes cause a problem if the leather has any stretch in it, for as the plaiting is pulled tight the strands will stretch and become narrower.

This should be allowed for by making the leather wider than the circumference of the handle before beginning to cut the strands.

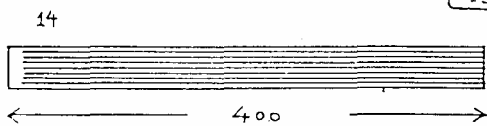

Fig. 14. Cut the leather into 8 strips, leaving just a small part uncut at the end.

Whipmakers always use the best part of the hide for the whip, and

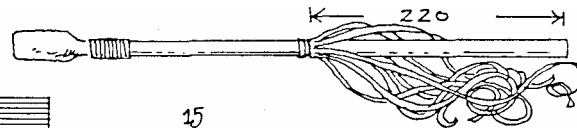
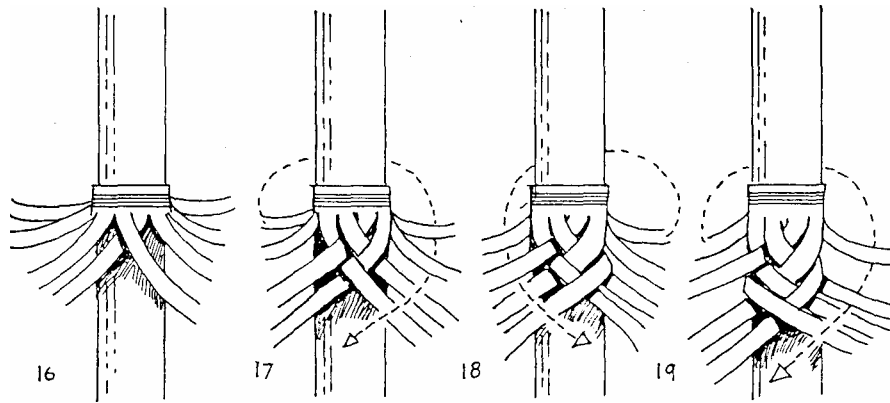
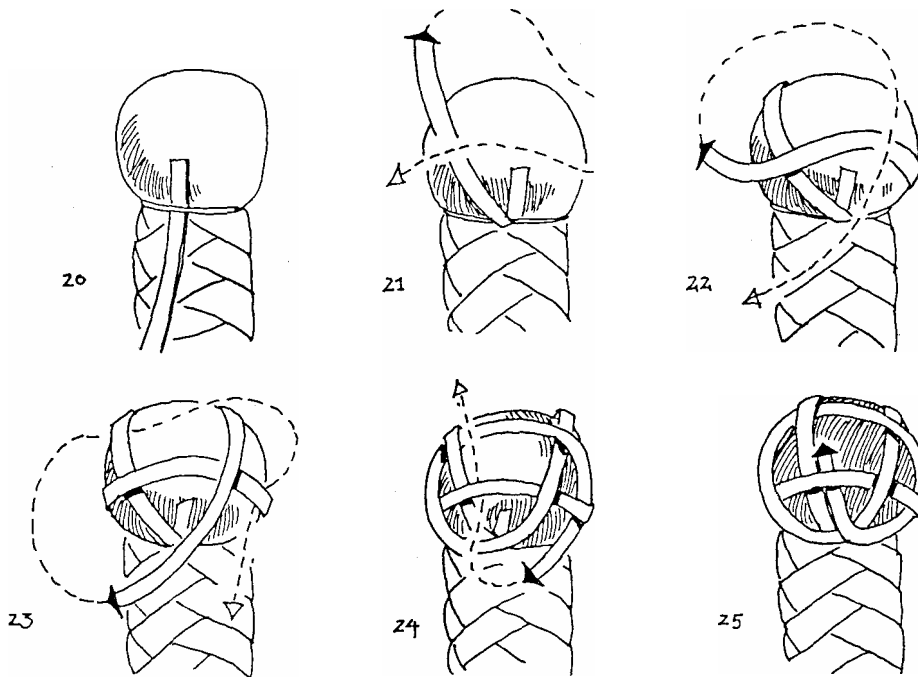

Fig. 15. The 400mm strands should cover 220mm when plaited. Tie them on at this point.





Figs 16-19. An 8 plait herringbone pattern is used. When using wide lace it is a good idea to arrange the strands as shown in the first two figures, otherwise a hole may appear here and the wood be visible.



Figs 20-24. This is the most simple Turk's-head to cover a knob. A more elaborate one is shown earlier in the section on fully covered whip handles. The amount of lace needed will depend on the size of the knob, but is usually around a metre.

The end of the lace is shown as

first being tied to the base of the knob. This is helpful but not necessary.

Fig.25. At this point the lace has come around to its own beginning and is now complete as far as the formation goes.

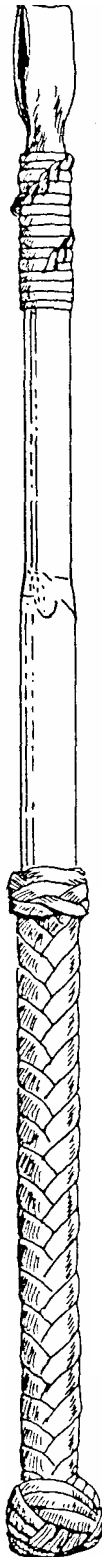

28

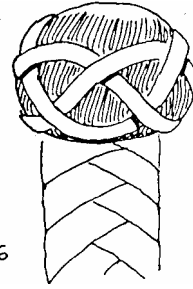

26

Before going any further try and arrange it in an even manner, as shown in fig.26.

The lace is then taken around again following the first one. This can be done two, three or even four times, until the knob is fully covered.

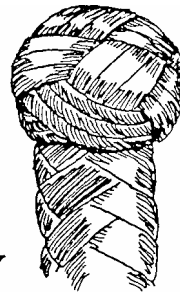

27

Fig.27. Work the strands tight, trim off the ends and the knob is complete.

Fig.28. This is the finished handle, in this case worked on a piece of lawyer cane.

The methods described in the first part of this section are probably the most common ones used. However there are many different ways of constructing whips, and in the following pages some other techniques are described.

I am always interested in hearing from people who may have other ideas, and can be contacted at the address at the front of this book.

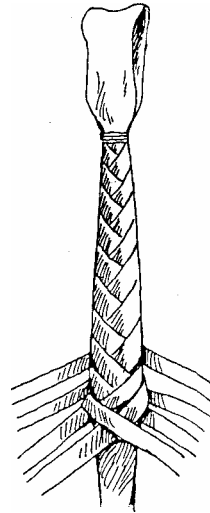



---



---

#### APPENDIX 1

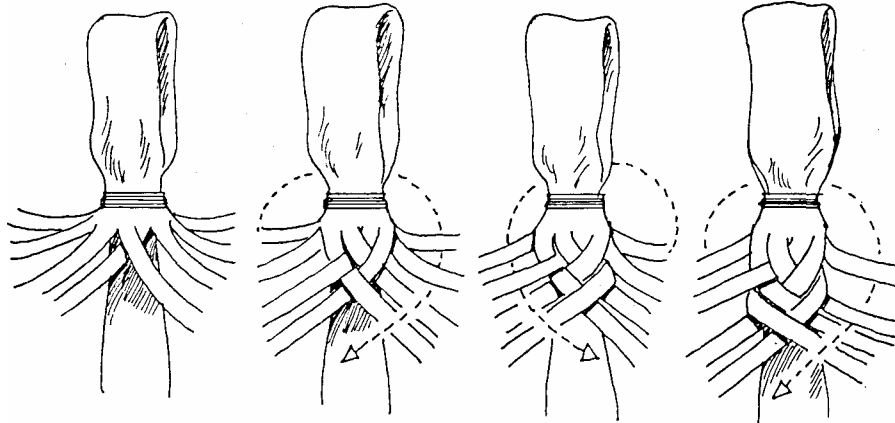
This is a slightly faster and easier way to begin plaiting a whip. However the method described earlier is still regarded as a better way to begin.



---



---

#### APPENDIX 2

##### ALL KANGAROO HIDE WHIP

It may happen that you have no other leather than kangaroo, and in that case the belly shape will have to be formed with it. The shape is cut out as shown, the last metre does not have a taper and can be 5-10mm wide. If 10mm wide it will be folded in two. The rest is rolled as tightly as possible. If it does not roll as tightly as desired wet it first.

Although very strong, this type of belly is not quite as flexible as the one described in the first part of the book, though it will loosen up with use.

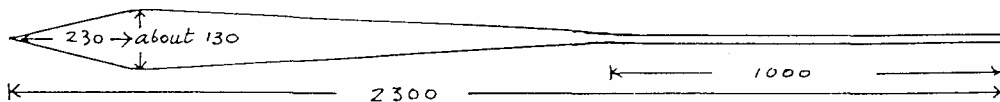

APPENDIX 3

COWHIDE BELLY

A full cowhide belly is faster to make than the method described earlier in the book. However it is often difficult to get a good smooth finish on this type of belly, so it is not as popular as the first method.

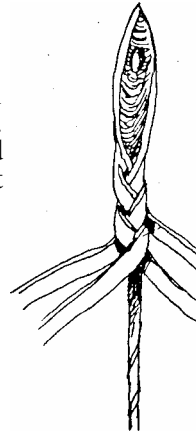

Fig.3. Hang the leather on a nail, give it a good greasing and then plait it with a four plait as shown earlier.

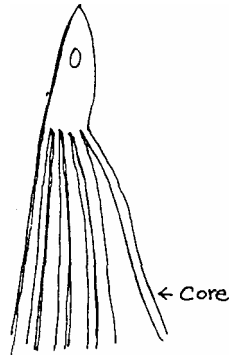
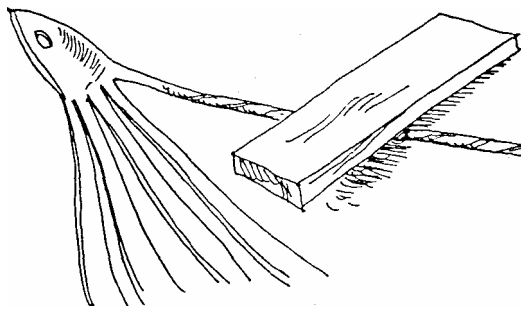

Fig. 1. Four strands are cut from the hide. They begin at about 3mm wide, taper out to 12mm after 230mm and then taper in for the rest of their length, coming to a point at 2.5 metres.

Exact measurements cannot be given as they vary according to the thickness and flexibility of the hide being used.

The edges are skived and the ends tapered and thinned as much as possible.

The core is also cut from the same strip of leather. This is 3mm wide and 2300 long.



then roll it hard until it is round.

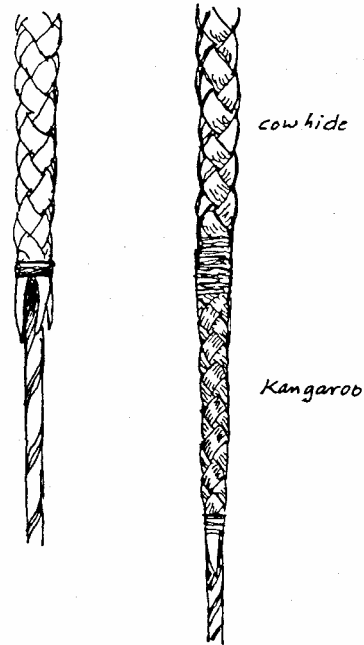

Fig.4. One of the problems with this type of belly is getting a good transition at this point, the whip should end up with a smooth taper, not a step.

Fig.5. To get a good taper tie on four scraps of kangaroo lace at this Fig.2. Soak just the core strip and point, and continue plaiting for a short distance.

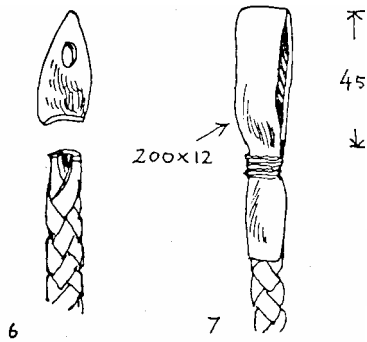
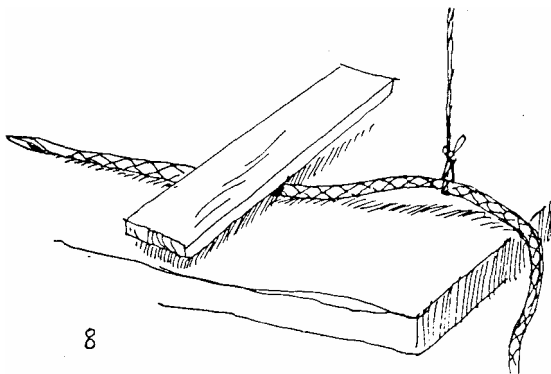

Fig.6. The end of the belly is no longer needed and can be cut off.

Fig.7. A keeper cut from kangaroo



skin is tied firmly on.

Fig.8. The belly is given a good rolling until it is quite smooth.

If there is any difficulty in getting a good finish it may be necessary to give the leather a good soaking in water before rolling.

When rolling is complete let the belly dry out and then give it a heavy dressing with fat or leather dressing.

#### APPENDIX H

##### A WHIP FROM PRE-CUT LACE

Because of the complexity of their shape whips are usually cut from a kangaroo hide. However for a person who wishes to make a whip for himself and cannot obtain a hide it is possible to make one with pre-cut lace, obtainable from leather-craft shops or saddlers.

The belly is made as described earlier, using the widest available

lace. The keeper can be of any good quality leather, bound tightly to the belly.

A better idea is to make the core extra long, say 3300 instead of 2300, and of a tapered shape so that it is a combination core and filler.



It is folded as shown to form the keeper.

Narrow lace is used for the top plait. The number of strands are calculated by measuring around the belly at the thickest part and dividing this measurement by the width of the strands being used, then adding an extra strand if the answer is not an even number.

For instance, if the circumference of the belly is 45mm it will need ten strands of 4.5mm lace.

The start of the whip is narrower than the widest part of the belly, and so plaiting should start as shown. The full number of strands are tied at the top, but only some of them are used in the first plaiting.

Extra ones are picked up as the whip widens, then plaiting continues as explained earlier, dropping strands as the whip narrows.

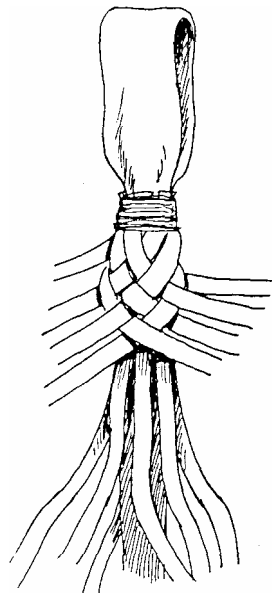

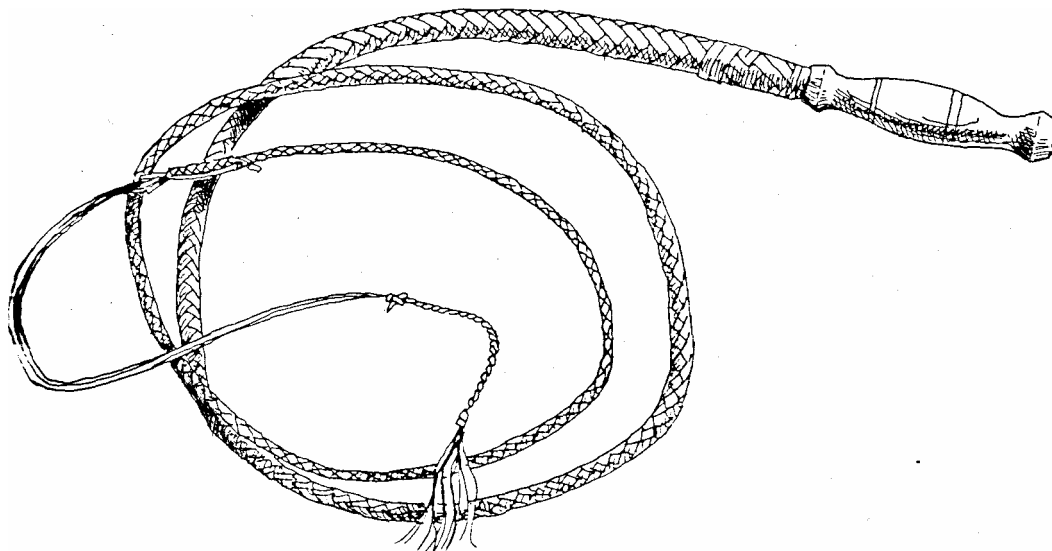

## Making a Bull Whip

These instructions are for a simple but efficient bull whip, a fancy whip would have a leather core and more elaborate plaiting.

To make this whip you will need wood for a handle, rope, cord, cowhide and kangaroo hide.

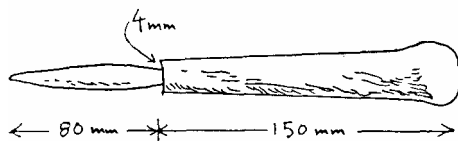
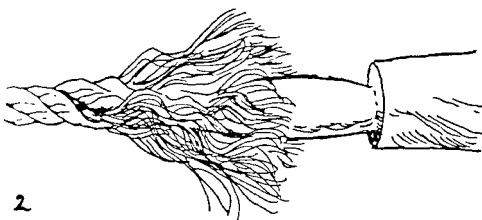

Fig.1. The handle can be shaped from any strong piece of timber, and to whatever shape you like. Note how the point is shaped so that the whip will not be able to slip off.



2  
Fig.2. Take some rope of around 8mm in diameter and 1800mm Jong, or as Jong as you wish.

Tease the end of the rope out and put it around the point of the handle.



3  
Fig.3. Bind the rope on with strong thread, making sure that there are no lumps.



4  
Fig.4. Cut and taper some scraps of leather and bind them on in order to get a good taper. The final shape of your whip will depend on getting a good shape at this stage.

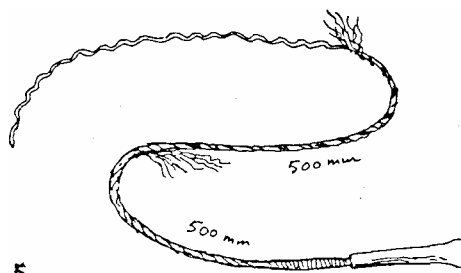

5  
Fig.5. The rope is now tapered by unwinding some of the strands and cutting them off.

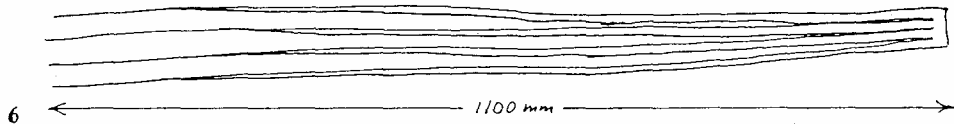

Fig.6. The belly is formed around the core, and this gives the whip its shape and bulk.

The leather for the belly can be 3mm cowhide, redhide, or you can even use kangaroo hide.

Cut the leather just over a metre long, and with a wide end that just fits around the point of the handle. Taper the four strands.

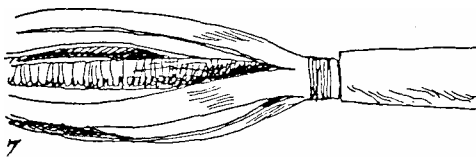

Fig.7. Use a whipping, as described elsewhere, to fasten the leather to the handle, or put in a few tacks.

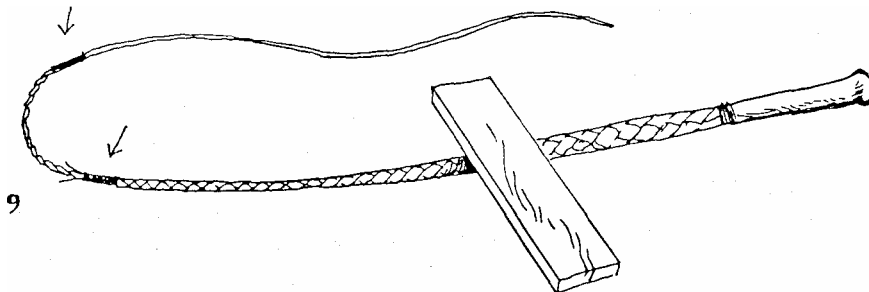

Fig.8. Plait the belly with a four plait.

Fig.9. Take a board and give the belly a firm roll. Keep rolling it until it is quite round and smooth, especially at each end.

This can also be done by rolling it under your boot.

Tape or tie up the end. Note that the frayed part of the rope has also been taped or tied up with thread.



The outer covering can now be plaited on. It is best to cut this from a kangaroo hide so that you can taper the strands, but if this is not practical then you can use pre-cut lace.

Let us say we are going to use an eight plait for the start of this whip. Measure around the handle where the whip is to begin, and divide this measurement by 8. This will give you the width of each lace at the beginning.

If the measurement is 56mm then each strand will be 7mm wide.

If using pre-cut lace you will not be able to get lace of this width, and so would have to do a 10 plait.

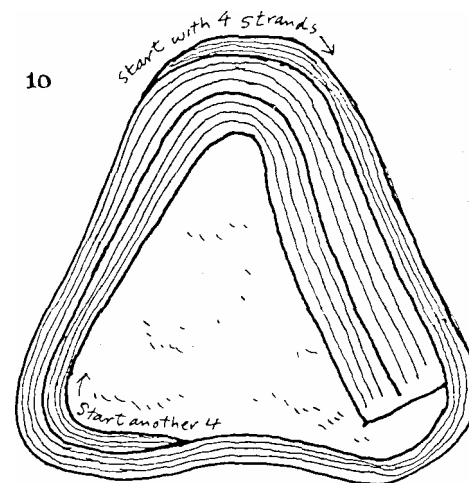



Fig. 10. This is not as complicated as it may first look. First the kangaroo

hide is trimmed to a smooth shape, and it will look something like this. 

Begin cutting, start with only strands and make them each 3mm wide. Having decided what the final width will be at the handle you slowly taper the strands as you go.

When you have cut 1200mm of lace you begin cutting another 4 strands, so that you are now cutting the full 8, all of the same width.

Continue cutting until you have a total length of 3200mm. For convenience of handling leave the strands connected together at the top.

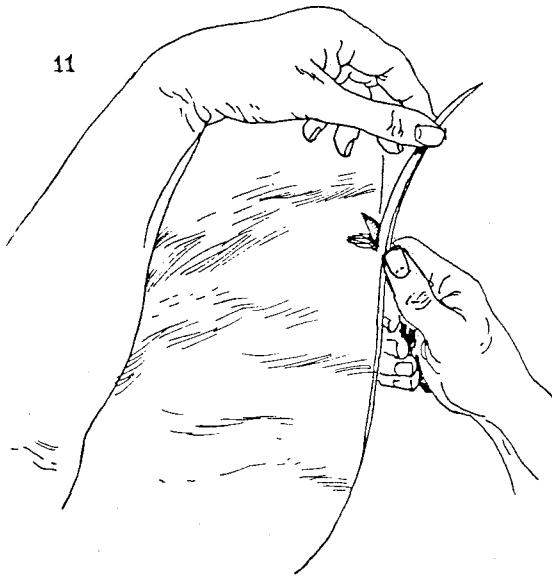

Fig.11. This is the cutting method shown to me by Lindsay Whiteman of Townsville. Sit down and put the hide on the bench. The thumbnail of the knife hand acts as a gauge while the other hand pulls the lace.

The knife needs to be extremely sharp to use this technique.

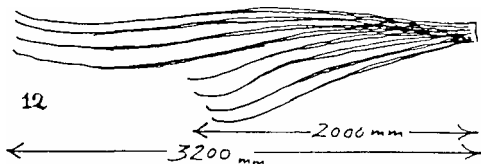

Fig. 12. Your set, as it is called, should now look like this.

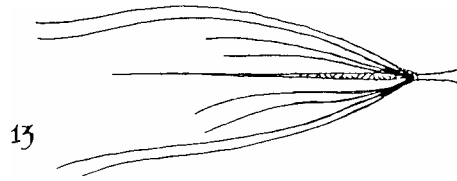

Fig.13. Tie these strands onto the handle. Divide the strands so that you have two short and two long in each hand.



Fig. 14. Begin an eight plait.

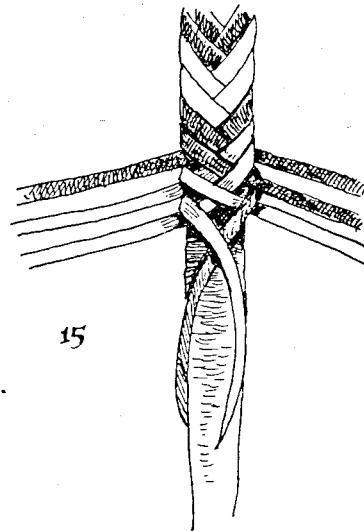

Fig. 15.

Continue plaiting until the work begins to bunch up. This will happen at about 1400 mm. Now you have to drop a couple of strands. Trim them off and lay them down on the belly as shown. Now continue plaiting a six plait.

When you have nearly used up the short strands drop them in the same way and continue to the end with a four plait.



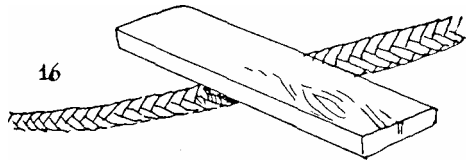

Fig. 16. Take a board and give the plaiting a good hard roll until the surface is smooth and round. Take care to do this firmly where the plaiting began.



Fig. 17. Put a whipping on at the handle end as described elsewhere.

18

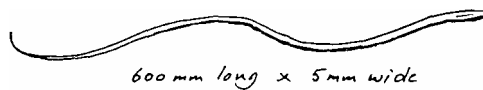

Fig. 18. Cut the fall out of strong cowhide or redhide. It has a slit at the wide end.

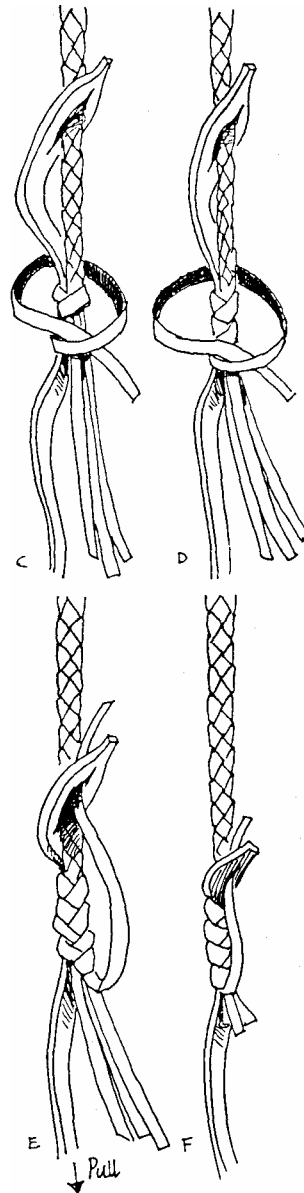
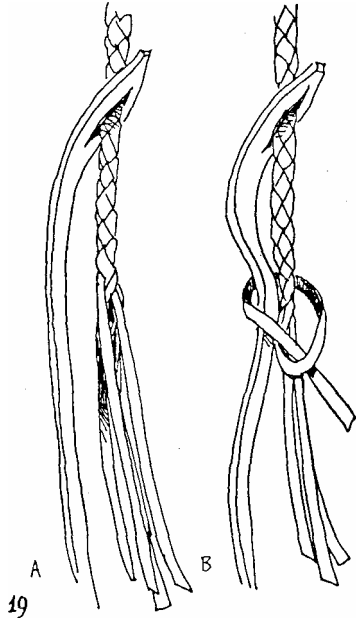

Fig. 19. Open the slit and put the end of the whip through it, then fasten it on as shown.



Fig. 20. The cracker is attached as shown.

For all practical purposes the whip is now complete. However if you would like to make it look just a little bit better then you can cover up the whipping on the handle with a Turk's-head.

There are hundreds of different sorts of Turk's-heads, but this is probably the easiest to work. →

You may use the same kangaroo lacing, or use some of a different colour.

The method is simple, you wind up, then down, then up again, going in between the previous strands. When the strand comes down again it goes under-over as in fig.4.

If you are using wide lace the turkshead will now be complete. If there are gaps you continue following round the previous working. This can be done twice, or even three times, and improves the look of the finished job.

When the beginning is reached again, work the knot tight and trim off the ends.

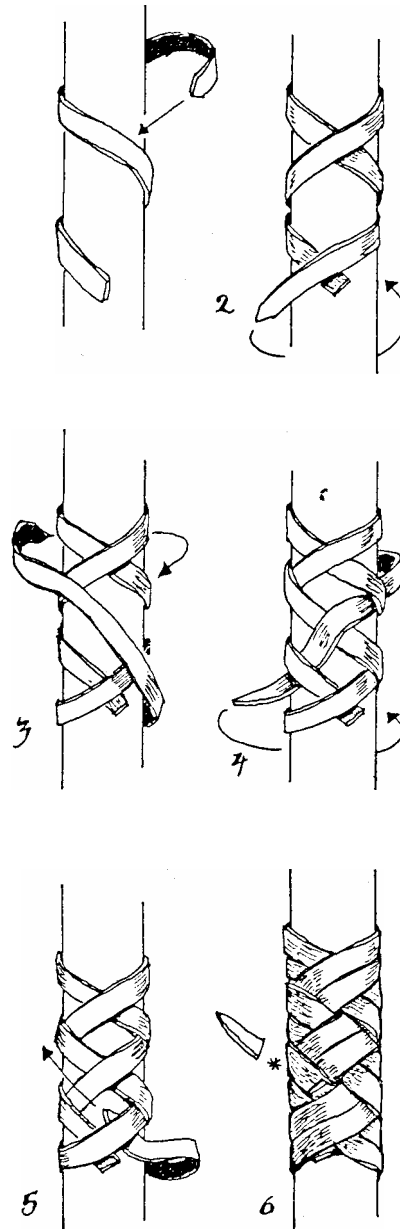
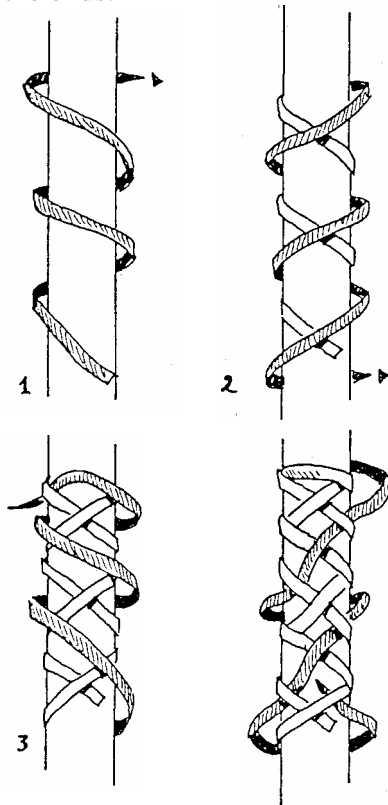

This sort of Turk's-head can be extended to any length, the drawings on the left show a longer version.

Having got to fig.4. you can go around once or twice again.

# Snakewhip

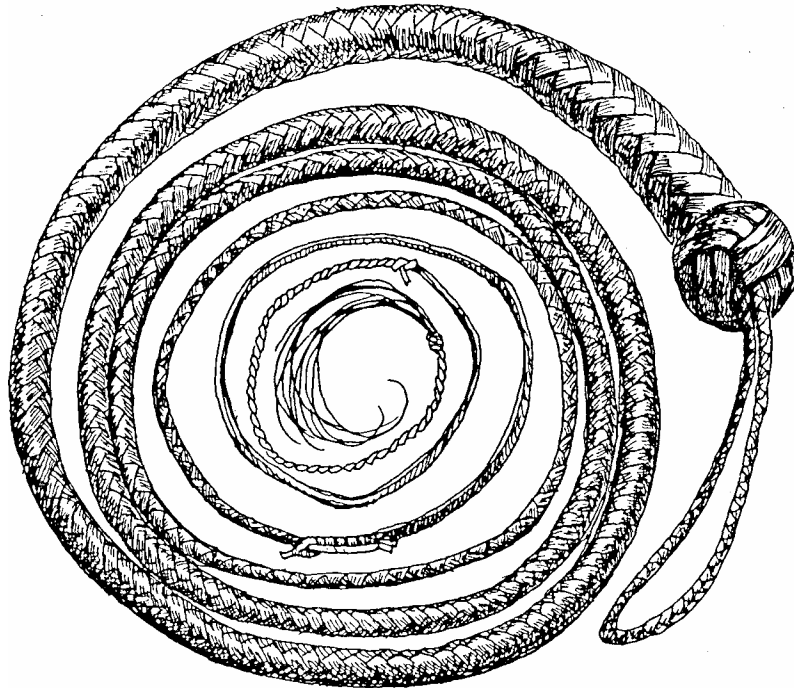

A snakewhip is rather like a bullwhip, except that the handle is also flexible. It is also usually a lighter whip. Its main advantage is that it can be rolled up and slipped into a large pocket out of the way when not needed.

Because of its shape it is also a favourite for playing tricks on new chums of nervous disposition, who are forever being scared out of their wits by someone throwing a snakewhip beside them and shouting out "Snake!".

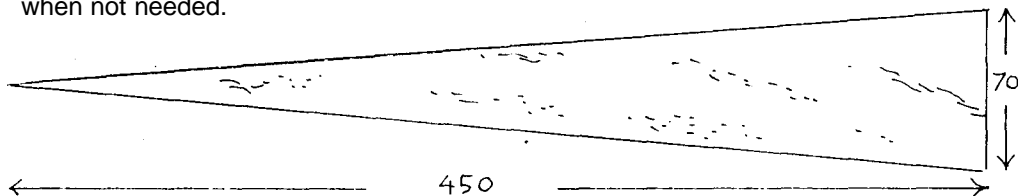

Fig.1. The handle can be of kangaroo skin or heavy canvas. It can be 60mm wide at the end or 70mm as shown here. The length can also be increased to 600 mm.

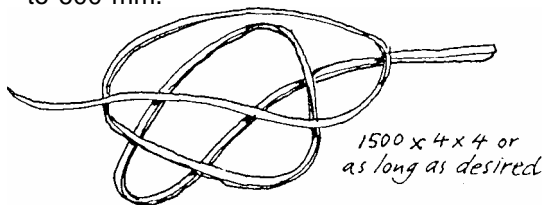

Fig.2. The core of the whip is of good quality leather 1500x4x4mm, or it can be made as long as desired.

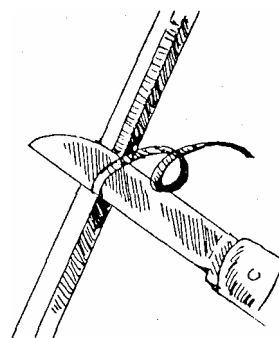
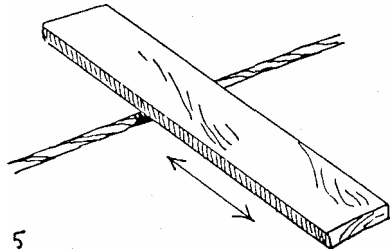

Fig.3. Use a sharp knife to round off the edges of the leather. It should be made as round as possible.



Fig.4. If you do not have any 4mm



leather then thinner leather will have to be used. Soak it in water and then twist it like this.

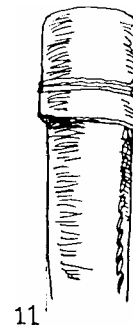
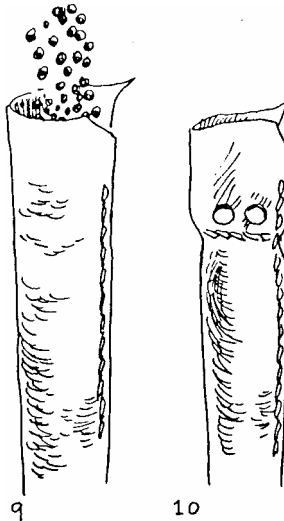

Fig. 5. Give it a firm rolling under a board until you have a uniformly round length of leather. If it shows no signs of unwinding you can go on with the whip making, otherwise it must be tied down and left until it has dried.

Fig.9. The handle is filled with lead shot. Some gun shops stock this. If it cannot be obtained the next best thing is small fishing sinkers.

Fig. 10. Sew the end closed leaving about 25mm spare. Punch two holes above the sewing if you are going to put a loop on the handle.

Fig.11. If you do not wish to put a loop on the handle then simply fold over the extra material and tie it down.

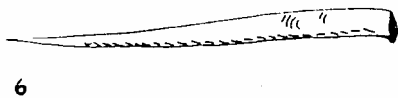

Fig. 6 The triangular piece of canvas hide is now sewn into



Fig.7 The core is placed into the end of the tube and held firm with at least one stitch.

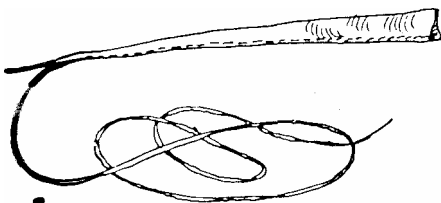

Fig. 8 The job should now look like this.

a tube.



Fig. 12. If the tube is of canvas it is turned inside out as soon as it is made to hide the seam. If it is of leather this will usually be too difficult, so the seam should now be spread out and smoothed flat.



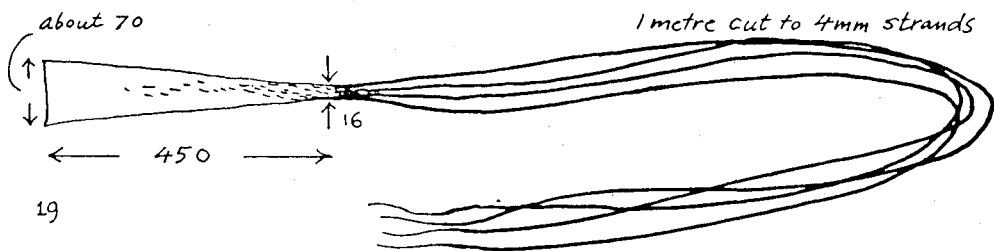
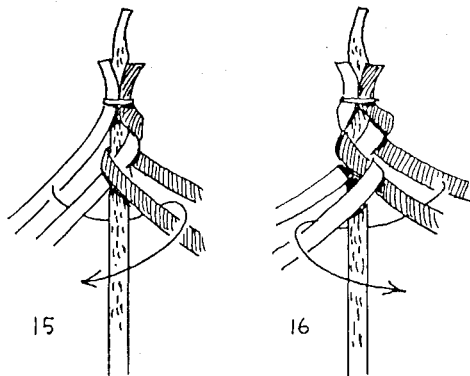
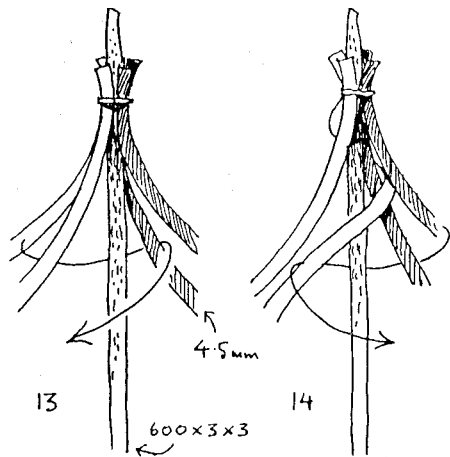

Fig. 19. Now comes the belly of the whip. This is an extra plaited section that gives the whip its shape.

This can be cut from 2 or 3 mm cowhide, or whatever leather is available.

One end of the leather is cut so that it just fits neatly around the lead filled handle. The remaining metre is cut into four strands each 4mm wide.

Fig. 13. A loop allows the whip to be hung up, and also is handy for hanging the whip up when doing the plaiting.

Take a strip of leather 600x3x3 and roll it under a board to make it round. Tie four strands of 4.5mm lace to it and begin a four plait. Figs. 14-16. This is the sequence for a four plait.

If you use a light leather for the

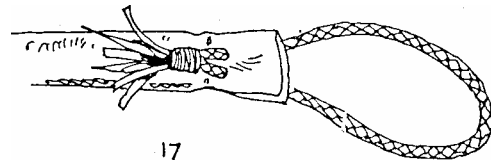

Fig. 17. Put the ends of the plaited-loop through the holes in the handle and tie them together very firmly.

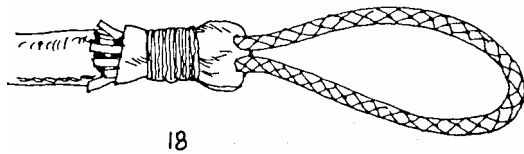
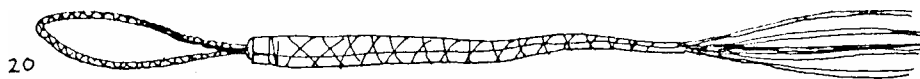

Fig. 18. Fold over the end and also tie this down firmly. The loop gets quite a lot of pulling so it must be made quite secure.

belly, such as kangaroo hide, it may be necessary to make it a bit thicker before doing the final plaiting.

This is done by wrapping a strip of leather right around the belly. The strip is cut to the length of the whip.

This is known as a bolster, and should be of flexible leather. Fig.20. Use fine thread to tie the belly to the handle. It should completely cover it with no overlap.



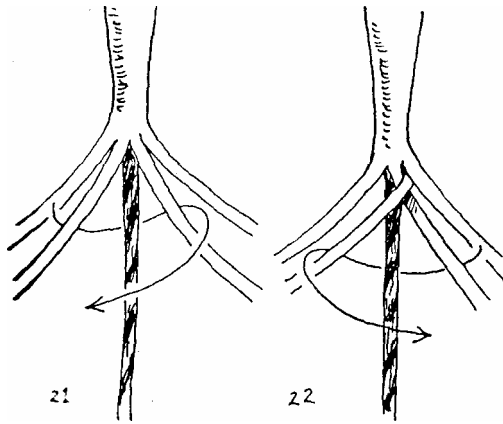

Fig. 21. The belly is plaited around the core. This is the same four plait that was used on the loop. Fig. 22. Plaiting continues in this way. When completed the ends can be tied down with thread.

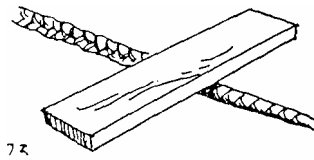

Fig. 23. Use a board and give the belly a good hard rolling to get it as smooth as possible. It may be necessary to wet the leather in order

to get a good finish. If this is done then also give it a oiling before going any further.

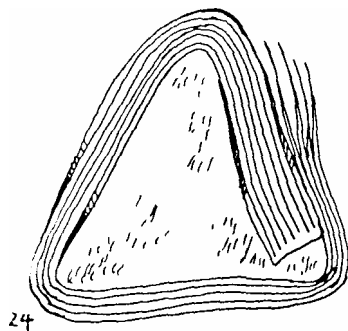

Fig. 24. The handle and the belly are now covered with a final layer of plaiting. This is cut from a kangaroo hide.

(It is also possible to do this using ready-cut lace if full hides are not

available, but the problem then is that you may have to start with as much as a 16 plait in order to cover the handle properly. By hand cutting the lace you can taper it so as to only have to begin with an 8 plait.) Begin by cutting four narrow strips, then increase it to six and finally eight, widening the strands as cutting continues. A very sharp knife and a steady hand are needed.

Purists cut the entire lengths by eye, but lazy people use a strand cutter to cut a uniform width for a certain distance, then do some freehand tapering, then use the strand cutter again for another length.

Fig. 25. This is how the strands should look when straightened out. The measurements are only a guide, but roughly you will lose a third in the plaiting and fixing on the fall.

Figs 26-28. The strands are tied onto the handle and plaiting begins. For the 8 plait the top strand is brought around the back, in between the opposite four and back to its own side.

The upper strand on the opposite side is then brought around in the same way, and so on.

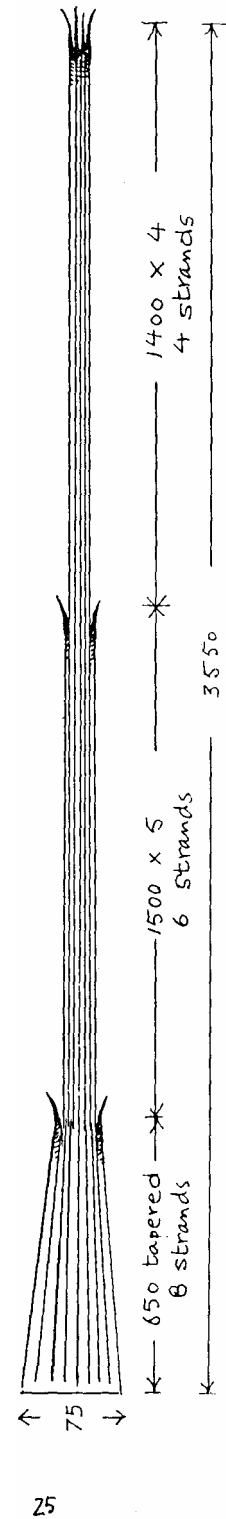

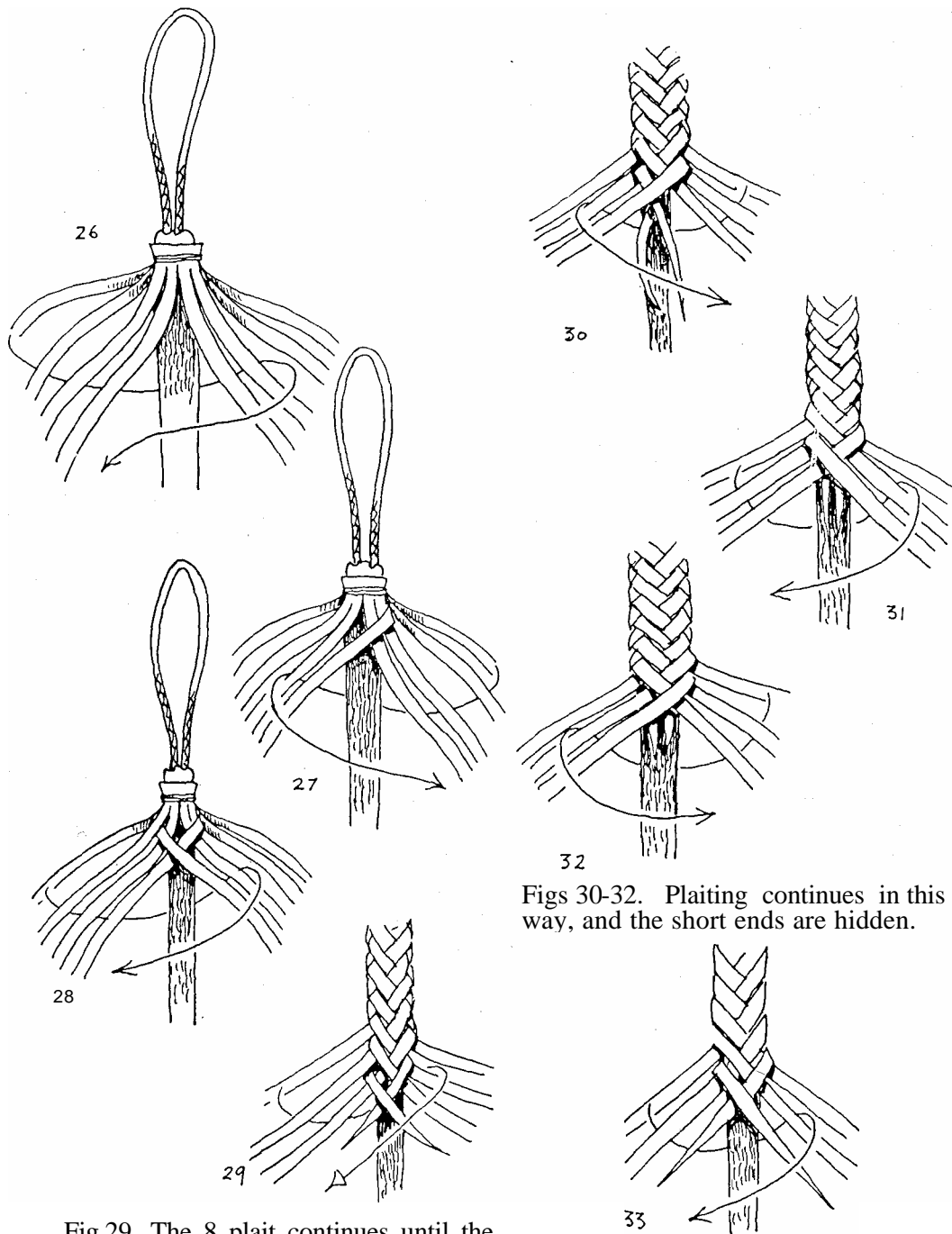

Fig.29. The 8 plait continues until the shorter lengths of lace are nearly used up, or until the plaiting becomes too bunched up.

When the short ends are in this position you change to a 6 plait. The top lace on the left comes around the back and goes below the top lace on the right as shown.

Figs 30-32. Plaiting continues in this way, and the short ends are hidden.

Fig. 33. The 6 plait continues until you again come to two short ends. Now the plaiting changes to a 4 plait. This is easy because it is the same sequence as the 6 plait. The top left strand is brought around the back and under the top right strand.



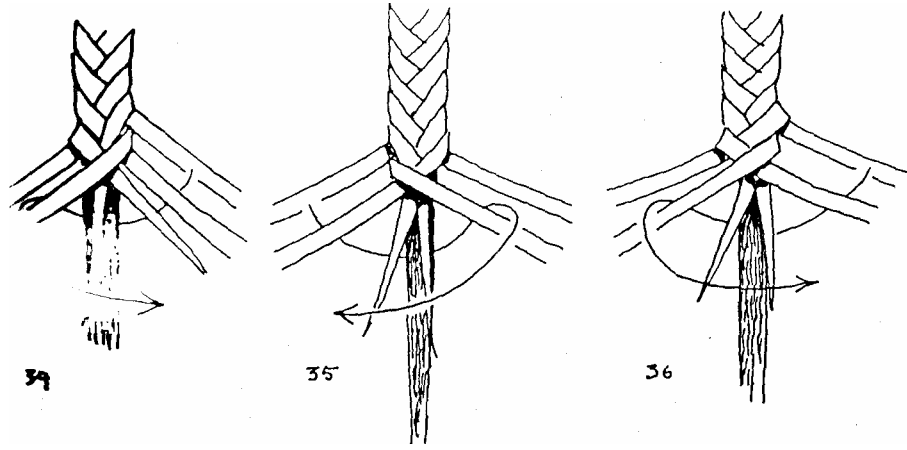

Figs 34-36. Plaiting continues in this way, and the 4 strand plaiting goes to the end of the whip.

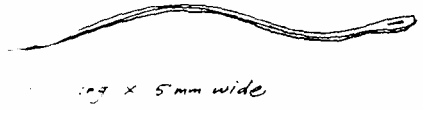

107 x 5mm wide

Fig.37. The fall is fitted to the whip. This can be of the dimensions shown or whatever you fancy. For a good whip the edges should be skived and the fall made as round as possible.

37 It should be of good strong leather such as redhide.

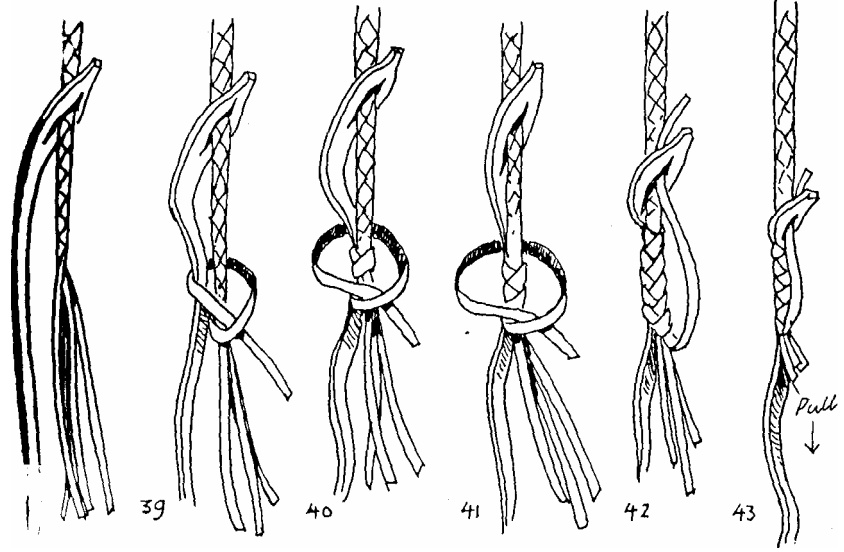

Figs 38-43. The fall is fixed to the end of the whip as shown.

Fig 44 If you wish to add a cracker to the whip it is attached to the fall with this knot.

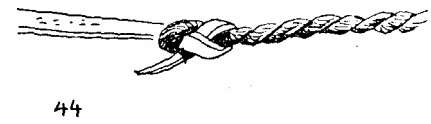

44

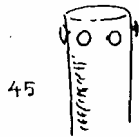

Fig. 45. The whip is now complete except for the knob on the handle. The shape of the knob is built up with string or thread.

On a wooden handle the shape can be built up by tacking on scraps of leather and then paring them down.

When making a whip with a wooden handle it is a good idea to partly drive a few tacks into the timber before winding on the string. This stops the handle slipping off.

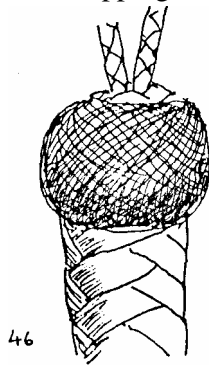

Fig. 46. Tacks cannot be used in the snake whip, so as a precaution it is not a bad idea to apply some glue to the handle before you begin winding the string or thread on, and plaster the knob with more glue as you build it up.

#### COVERING THE KNOB METHOD 1

A Turk's-head is used to cover the knob. There are two ways to tie this particular Turk's-head, and I have illustrated both.

The first is tied on the knob itself, while the second is first tied around the fingers and then slipped over the knob.

Some whipmakers use the first method, others prefer the second. I tie it around my fingers because I find it easier to remember this method. Harry, who makes whips for our saddlery business, always ties around the knob.



Fig. 47. The length of lace needed will vary from knob to knob, but 1.5 metres of 4 or 5mm lace should be ample.

The end of the lace can be tied as

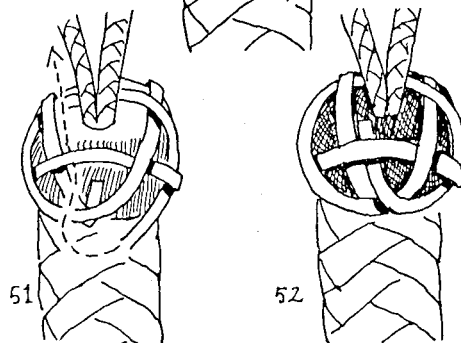
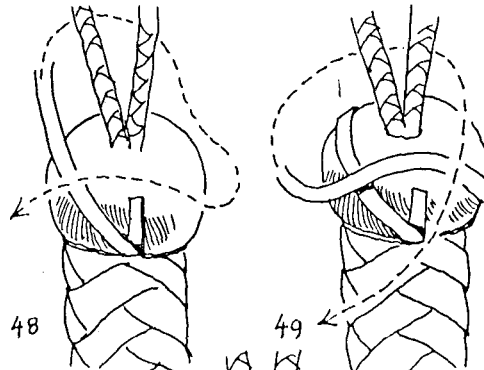

shown, or just held with the thumb. Figs 48-52. This is how the knot is formed. When completed as far as fig. 52 move on to fig. 60.

METHOD 2

Figs 53-59. This is how to form the Turk's-head around the fin gers.

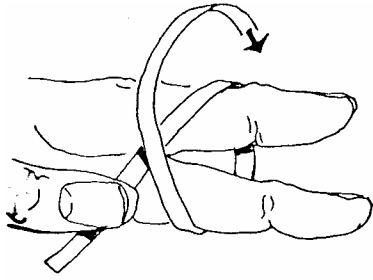

53

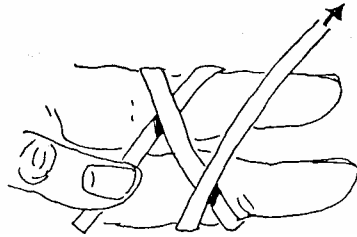

54

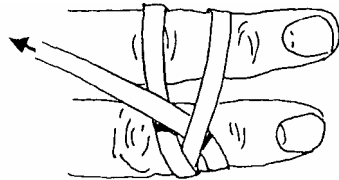

55

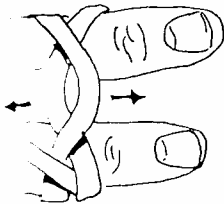

57

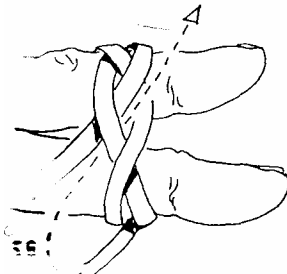
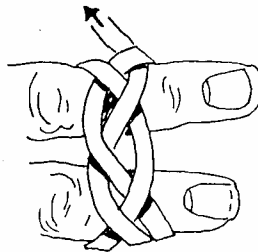

58

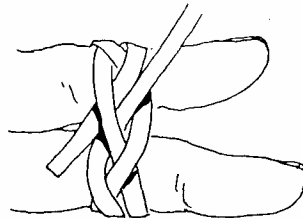

59



Fig.60. The Turk's-head is spread around the knob like this.

The remaining lace is taken round the knob two, three or four times, following the first run, until the knob is covered.

Fig.61. This is how the finished job should look. In this case the lace was taken around three times.



61

9  
HOMEMADE  
LEATHERWORKING  
TOOLS

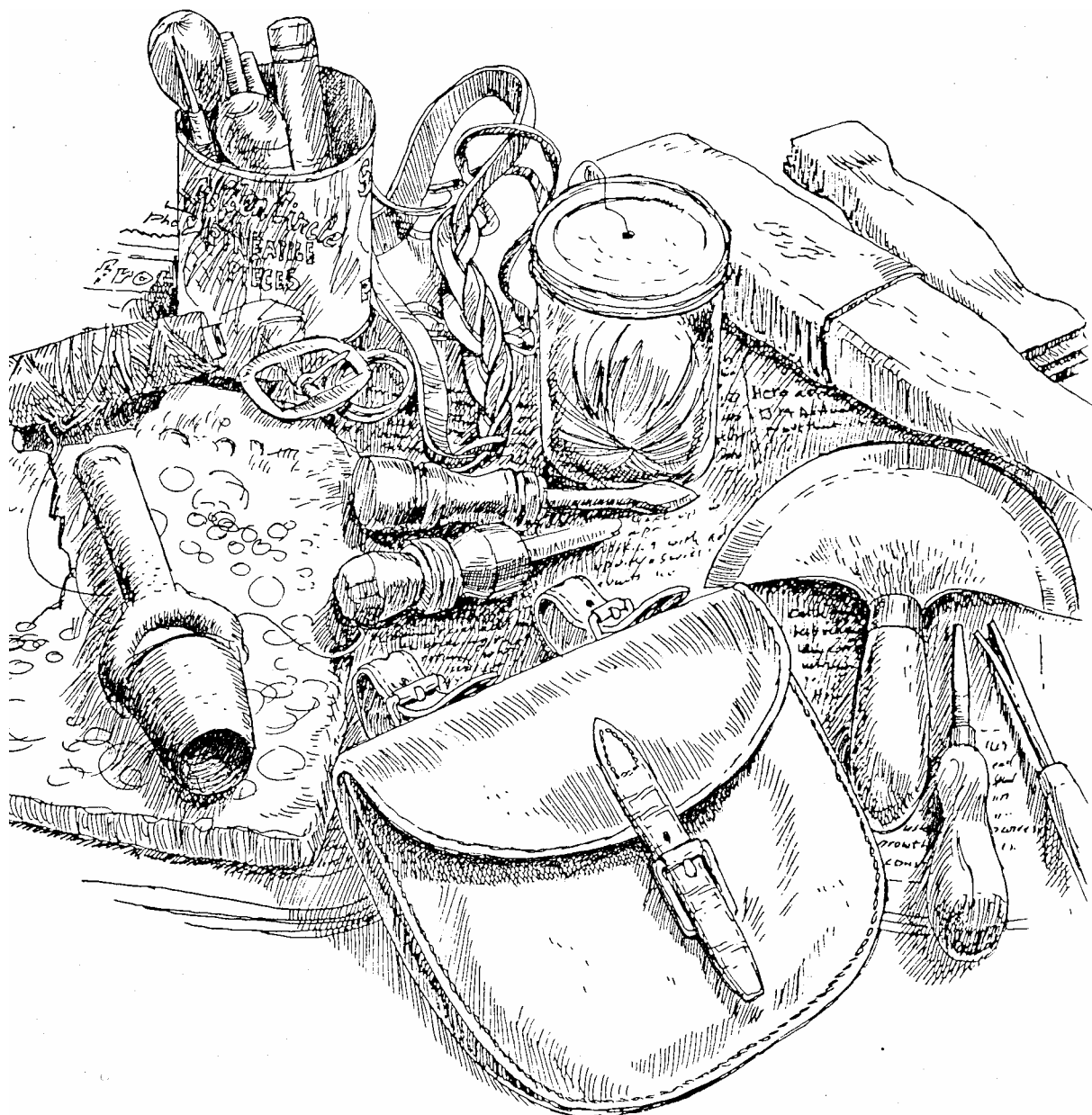

# Hole Punch

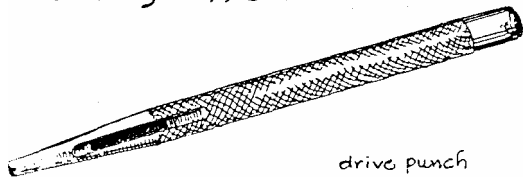

drive punch

Holes are punched with either a rotary punch or a drive punch. The rotary punch looks like a pair of pliers and is favoured by the amateur worker because the head can be revolved to bring into position different sized punches.

This type of punch is not favoured by saddlers because it is tiring to use on big jobs, and because the punching tubes wear out fairly quickly. Instead they use drive punches.

The drive punch should only ever be struck with a rawhide or wooden mallet, otherwise it too will soon wear out.

It is not practical to make small drive punches, but I have found large ones that have been made by simply sharpening up a piece of metal tube.

However home-made punches do not work very well due to the constant problem of having to remove the circles of leather from inside the tube.

To overcome this the punch must be designed differently, and the sketch shows a large one made for us by a local blacksmith.

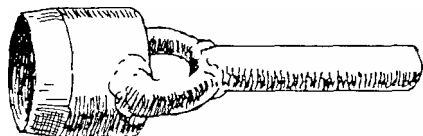

This punched a 30mm hole.

Punches of this size are not used so much for making holes but rather for producing circles of leather for various jobs. The blacksmith also produced a similar type of punch in the shape of a heart, and people would have their initials stamped on these and hang them around their necks. For us it was a great way to use up all the small scraps of leather.

When making up jobs that are to be sewn together with leather lace most people prefer to punch holes because it is easier to thread the lace through them.

Some craftsmen consider these holes to be ugly and prefer to cut slits for the lace. The slits look neater on the finished job.

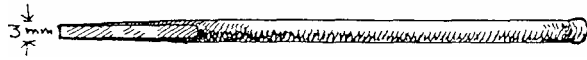

A slit punch can be made in minutes by hammering the end of a large nail flat and then sharpening it.

The job of punching slits can be speeded up by using a punch with a multiple head. The sketch shows a

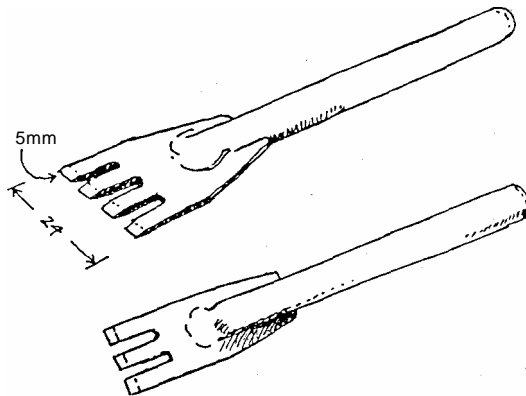

commercially made pair.

A multiple punch can be made by grinding down an old file and cutting teeth into it.

The steel in files is very hard and will soon blunt the blade of the hacksaw when cutting the teeth, so

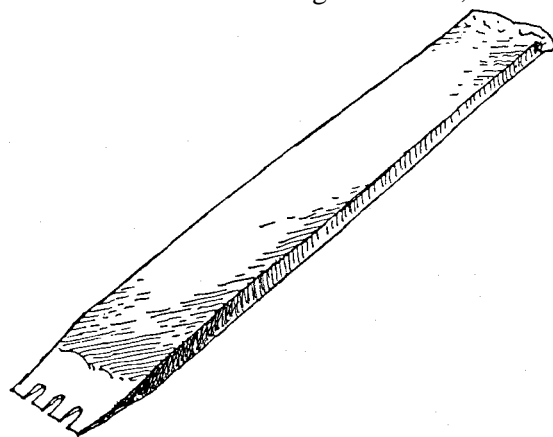

first heat it red hot and let it cool down slowly.

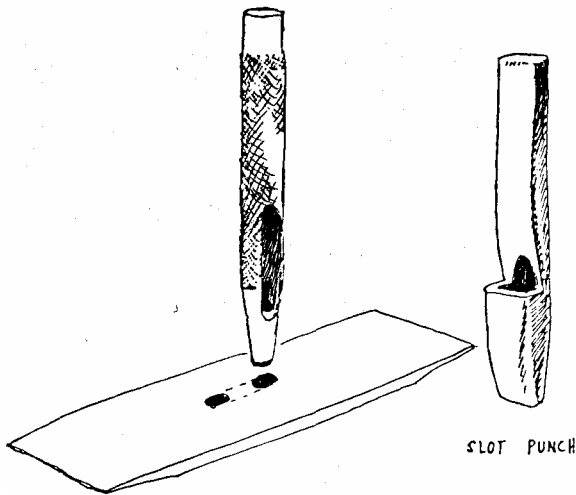

### SLOT PUNCH

Slot punches are very expensive, and homemade ones are not usually very good.

The answer to this problem is to simply punch two holes with an ordinary round punch and then join them with two cuts of the knife.

## Mallet

Leatherworkers usually have a couple of mallets, a heavy one used when punching large holes and a lighter one for use with decorative stamps.

Punches and stamps should never ever be struck with a metal hammer as this will mushroom out the end of the tool and shorten its life.

I have seen an expensive punch reduced in length from 100mm to 35mm over a couple of years by a slipshod worker with a steel hammer.

The rawhide mallet is the best for leatherwork, a stamp will last a lifetime if only ever struck with one of these.

190

I have yet to meet anyone who has successfully made a rawhide mallet, but it is an easy job to make a wooden mallet.

This can be chopped out of any scrap of hardwood. Softwood is not suitable as the ends of the metal tools soon break up the surface of the wood.

The shape and size is a matter of personal choice, usually governed by the piece of timber that you choose for the job. The one in the sketch is 70x50x330, and is also used as an ordinary woodworking mallet when using chisels. This size is right for punching large holes, but too large for use with decorative stamps.

360x50x30 is a better size for a stamp mallet.

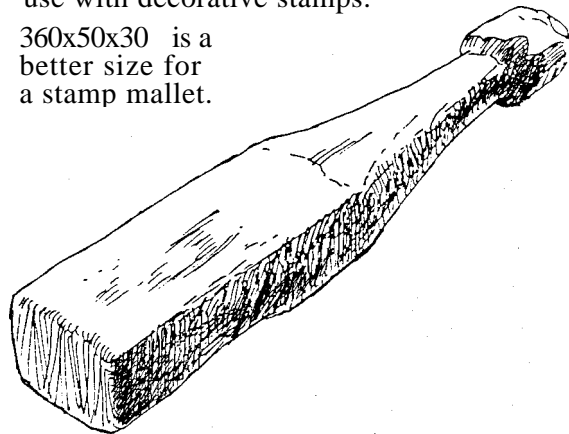

Many of the top American leather carvers prefer this style of mallet for carved leather work.

They do not hold it in the conventional manner as is done when punching holes, but instead hold it so that they are looking at it side on.

This allows a more controlled strike, as well as giving a better view of the stamp. The smaller mallet is also made from hardwood, the heavier the better.

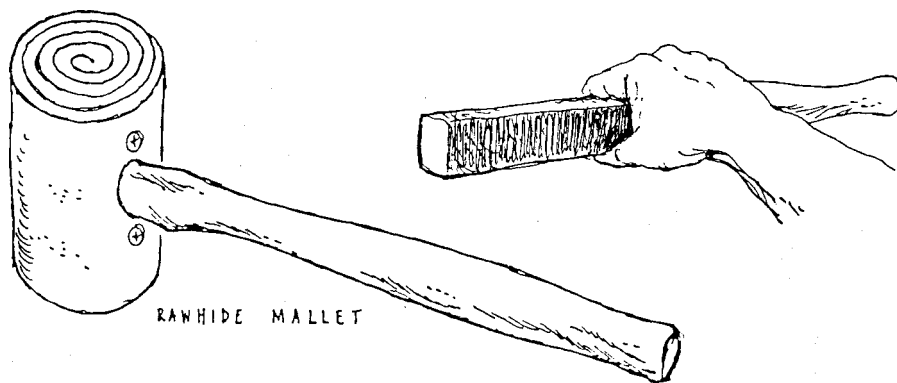

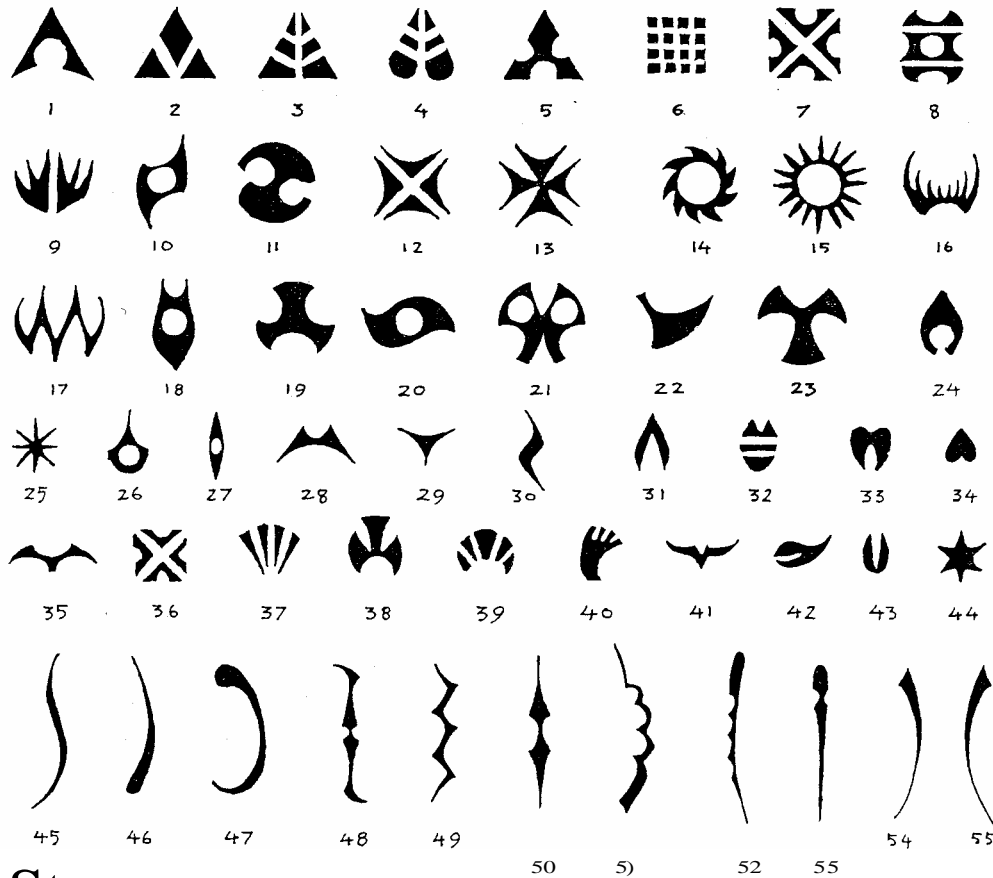

## Stamps

There are three ways to decorate leather, carving, embossing and stamping.

\* In carving the design is cut into the leather and various tools are then used to press down parts of the design and also add texture and patterns. American saddles are decorated in this way.

\* Embossing is an old technique for which only a single tool is needed. The making of an embossing tool is described in this booklet. Any freehand design can be embossed onto leather.

\* Stamping is the creation of various decorative patterns by the use of stamps which are struck into the moist leather using a leather or wooden mallet.

A large variety of commercially made stamps are available, but a good working collection can easily cost a hundred dollars or more.

It is possible to make a good collection of stamps by hand at no cost at all. The illustration shows the fifty or more that are on my bench at the present.

These have been made over the years, often to make up a particular design. They are made from scrap steel, large nails or old files.

Designs .1-5 are made from three-cornered files. Files are very hard, and in order to soften them they should be first heated to red hot and then be allowed to slowly cool.

A simple and attractive design such as no.2 can be made with just two cuts with a hacksaw.

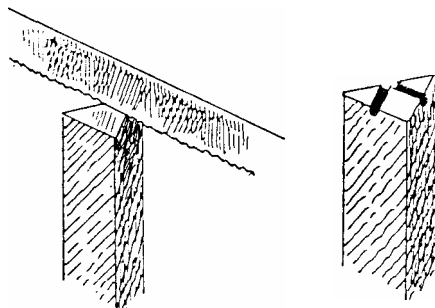

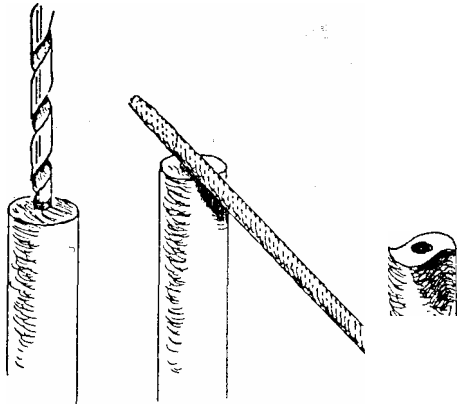

Offcuts of round mild steel are very useful. A good variety of designs can be created by drilling holes and then using a file. This is the design shown in no.20.



Other designs, such as no. 16 are created just with the file.

Flat steel can be used for the long designs 45-55. Sometimes the steel may be hammered into a curve, but



most of the work is done with a file.

The amount of dampening needed by the leather before the stamping is done varies according to the type and finish of the leather. Some leather needs only sponging with water while certain types of harness leather require soaking. Experiment with a scrap before beginning.

192

## Tools

The difference between leather carving and embossing is that in carving the surface of the leather is actually cut and then hammered down with a variety of tools. This makes the design stand well out from the leather.

When leather is embossed the background is only pressed down, usually by hand, and so the design does not stand up so high.

Embossing is a very old art, probably much older than carving, and it is a pity that it has gone into a decline.

Its great virtue is the small number of tools required. Quite a few tools are required to properly carve leather, but embossing can be done with one simple tool that can easily be made by anyone.

They can be made with scraps of fencing wire or brazing rod. Brass is good because it does not rust.



The wire is slightly hammered and then bent. It is ground into the shape shown and made as smooth as possible. The actual dimensions do not matter, it may be an idea to make a small one for fine work and a larger one for broad curves.

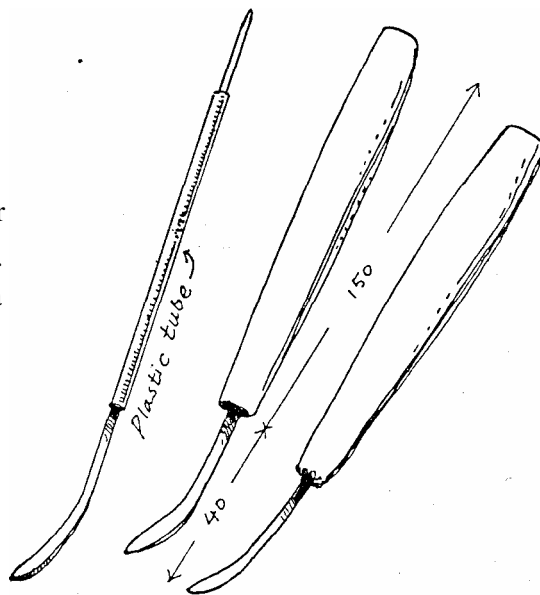



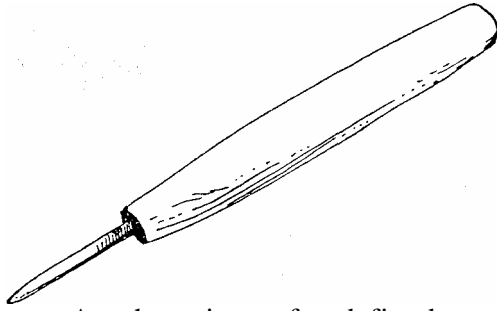

## Cutting Straps

This is an early type of strap cutter that I found with some old tools.

It consists of a stick with a small blade wedged tight into a hole at one end, and a sliding piece which is held in position with a wedge.

It is included as a matter of interest, but it is not an easy tool to use.

Another piece of rod fixed to a handle and with a smooth end can be used for drawing the design on the leather.

The technique of embossing is also very simple. The design is drawn onto the leather, the leather is dampened and the embossing tool is used to push down the background and so give the effect of the design standing above the surface.

I was taught the technique at the age of twelve and found that it was no trouble at all.

The sketch is a detail from a book cover that I embossed when about sixteen. Once done the embossing is there forever, and this specimen is getting on for forty years old.

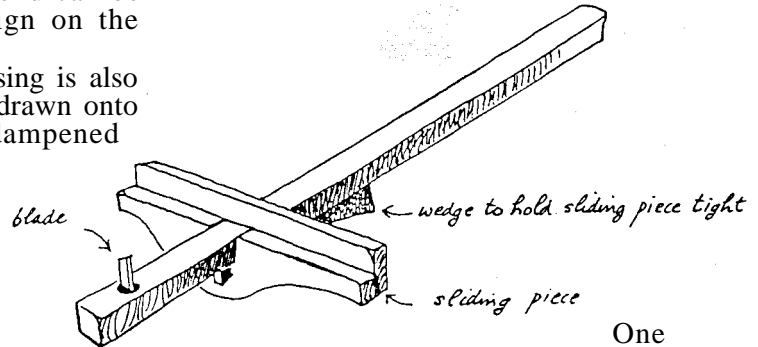
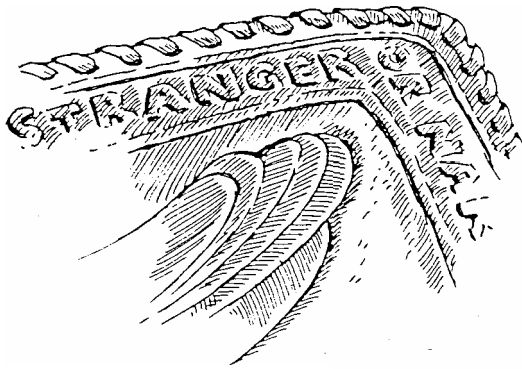

One trick used by old time bootmakers when cutting straps was to jab one of their very sharp knives into the bench top and pull the leather against it. They would either do the cut by eye or clamp a block of wood to the bench to act as a guide. Bootlaces would be cut by eye.

The main problem with this method is that if you are cutting thick leather it is difficult to get the knife fixed so firmly that it will not fall over backwards when you begin work.

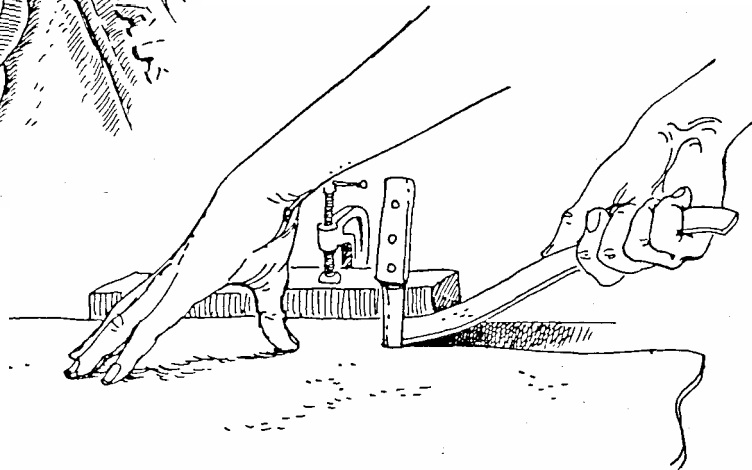

# Plough Gauge

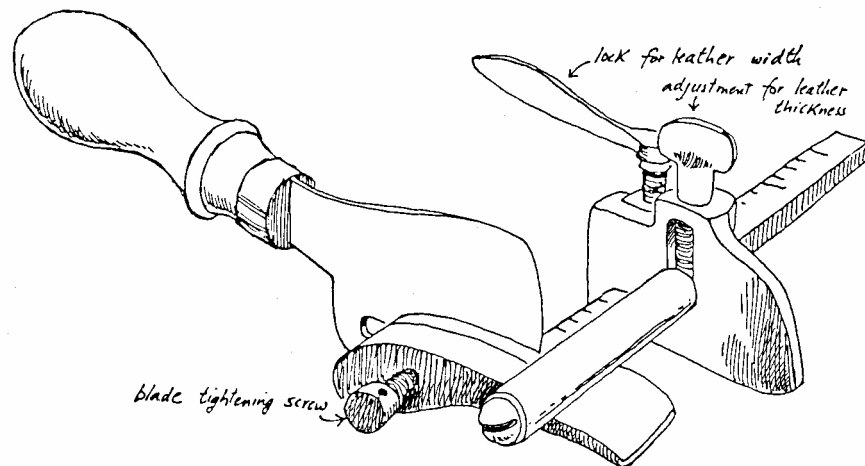

If you do a lot of leatherwork it would be best to buy a proper plough gauge for the cutting of straps. There are all sorts of tools designed for cutting straps, and many of them are very cheap and nasty.

Unfortunately the best type of plough gauge is also the most expensive, and is of the style shown in the sketch.

On the left is the handle and the blade. To the right of this is a roller which can be moved up and down, and is adjusted according to the thickness of the leather being cut.

The roller stops the leather buckling up, and so ensures a good even cut.

To the right is a sliding bar that is adjusted according to the width to be cut.

It is usually necessary to begin the cut with a sharp knife and then feed it into the plough gauge. The right hand grasps the blade handle while the left holds the strip being cut, pulling it slightly away from the side as the cut is made.

The blade must be kept very sharp, and one old leatherworker's secret is to sharpen the inside of the blade more than the outside.

This helps prevent any tendency that the knife might have to wander inwards and make the strap thinner than was intended.

## HOME-MADE PLOUGH GAUGE

The factory made plough gauge is a very nice piece of equipment, but it is also very expensive.

However if you have to cut a lot of straps it is quite possible to make a plough gauge that will work almost as well as a bought one, and will certainly speed the work up to a marked extent.

Two variations are described here, and the first is the most simple.

The materials for this one consist of two scraps of timber, plus a piece of hardboard or plastic the same thickness as the leather to be cut, two small G cramps and a knife.

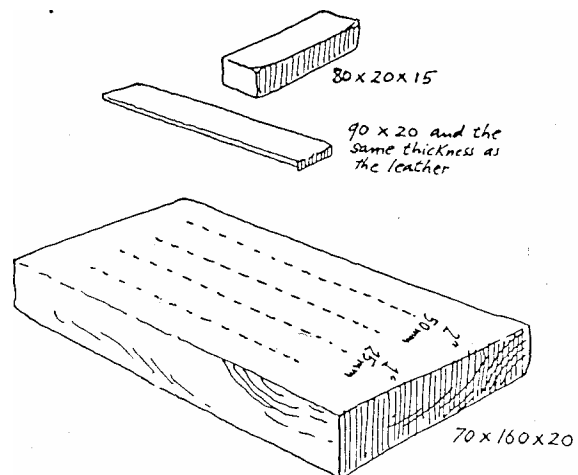

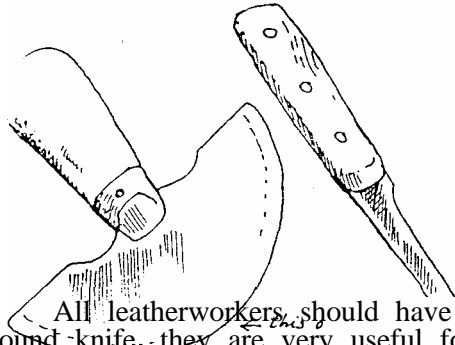

All leatherworkers should have a round knife, they are very useful for trimming straps and skiving, but if you do not have one then you can make do with a bootmaker's knife, though this does not work nearly as well.

In the sketch you will notice that the larger piece of wood has lines ruled on it and these are used to measure out the width of strap to be cut.

The piece of hardboard is placed on this board with its edge against the measurement that the strap is to be cut to.

The remaining block of wood sits on this at right angles, and is held in place with a G clamp. This forms a bridge under which the leather has to pass.

The blade is clamped into position and the gauge is ready to use. The right hand grasps the handle of the round knife while the left holds the end of the leather to be cut. The round knife is then pushed through the leather. In order to make this simple tool capable of handling various thicknesses of leather the strip of hardboard can have steps glued to it as shown.

The top block can then be positioned on whichever height is the correct one for the leather being cut.



These steps can be cut out of the plastic used for margarine containers, or other household containers

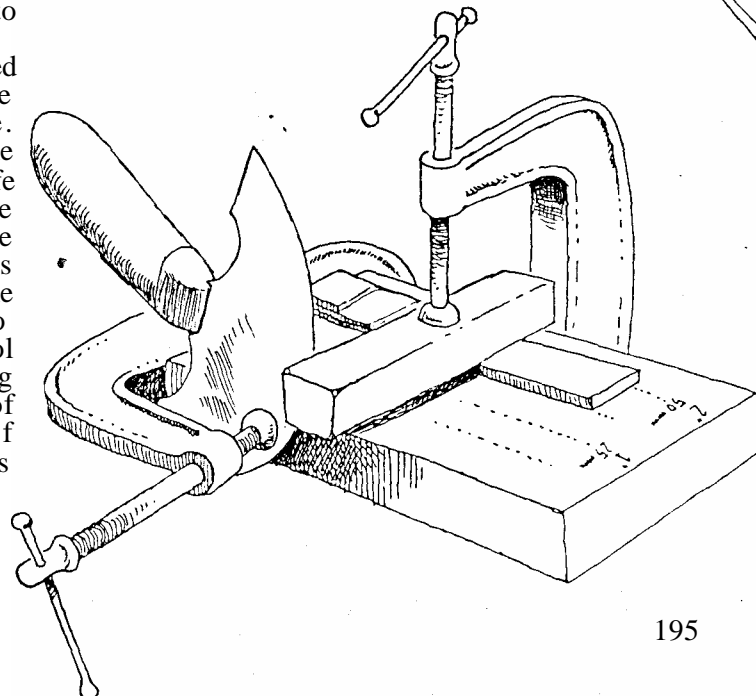
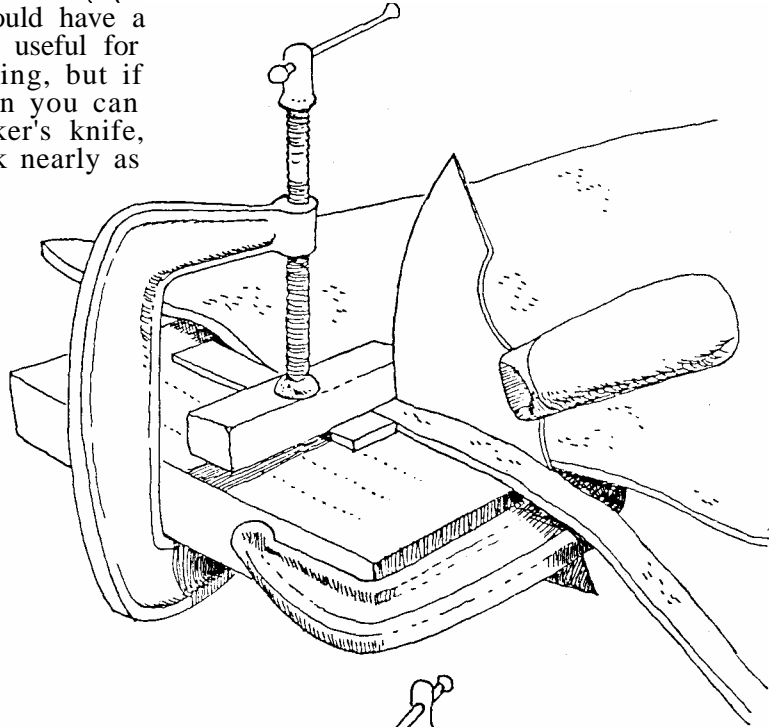

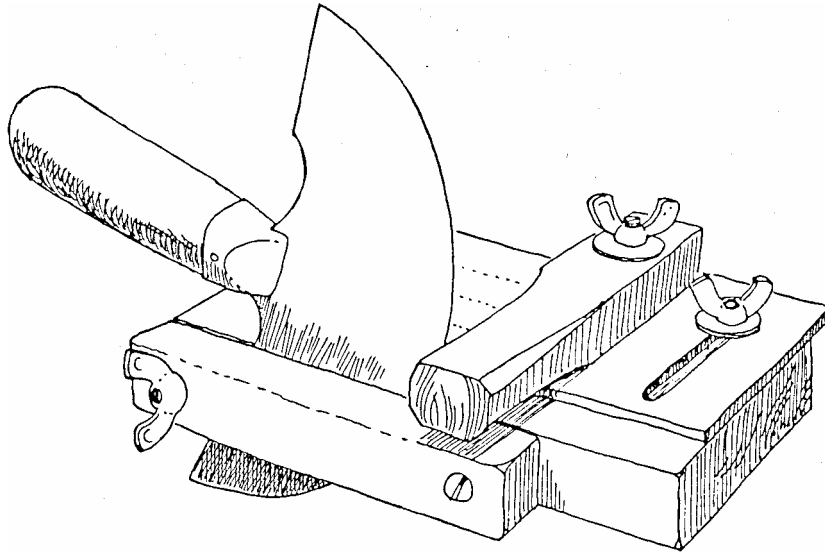

### A MORE ELABORATE GAUGE

This gauge works on the same principle as the previous one, but does away with the G cramps, which do tend to get caught up in things.

A larger piece of hardboard is used, and this is slotted so that it can be moved to whatever position is required. It is held in place with bolts and wingnuts.

The top piece sits on this, and spacer pieces are slipped under it if it needs to be raised. These can be cut from the plastic sides of margarine

packets.

When the gauge is to be used the round knife is slipped into the slot and held firm with a wingnut.

In theory any sharp knife could be used in this gauge, but in practise I have found the round knife to be by far the best.

Not only does it provide a handle in the right place but the blade seems to be at the best angle for cutting.

The measurements given here can be modified as desired, the design is quite flexible.

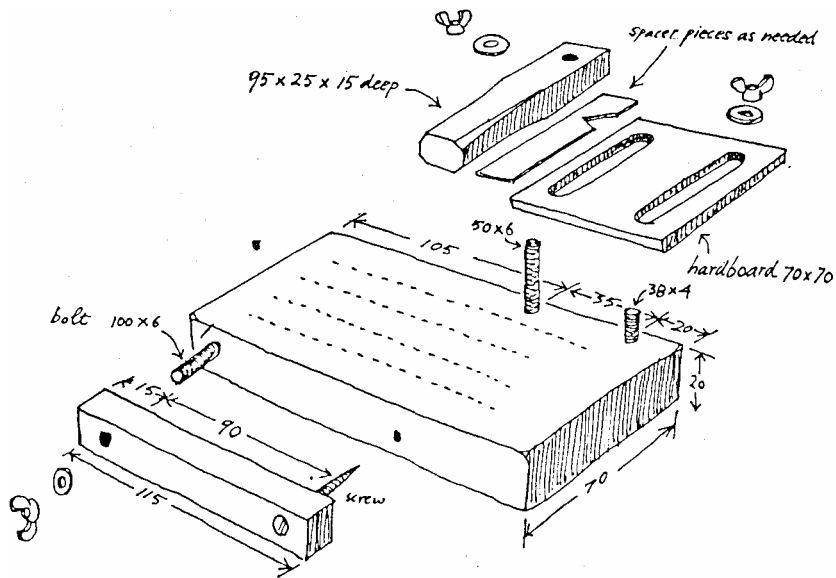

# Edge Shave

This tool is used to give a nice rounded edge to the leather. All good leatherworkers use one of these tools on

A few years ago, due to some shipping problem, we could not get any edge shaves for six months, and as customers were waiting for them we had to set to and make them ourselves. We made several dozen, and they worked just as well as the imported models.

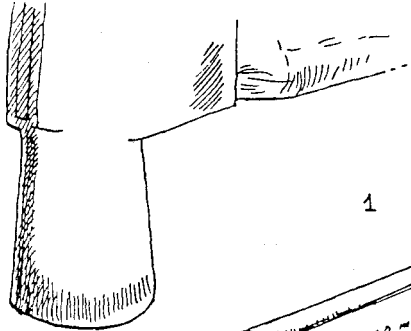

1

Fig.1. Take a 120mm length of heavy fencing wire and flatten one end as shown. There is no need to heat the wire.

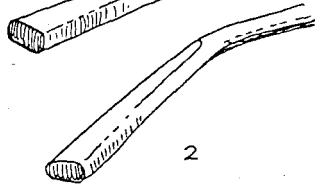

2

Fig.2. Bend the wire down a little.

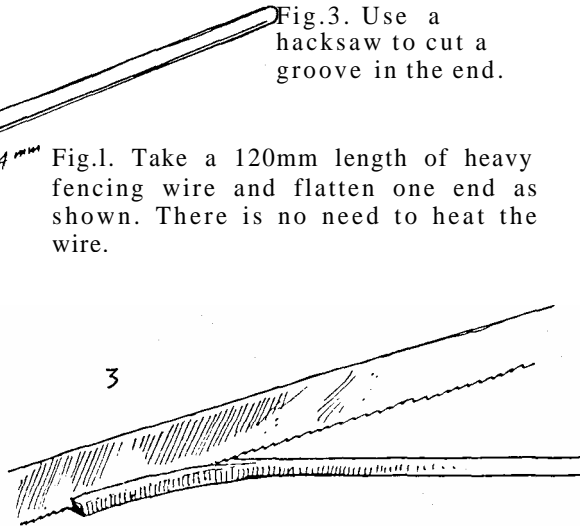
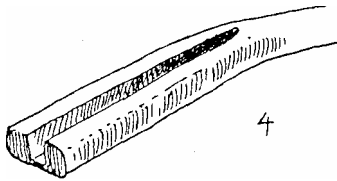

Fig.3. Use a hacksaw to cut a groove in the end.



4

every job.

Fig.4. This is how the groove should look.

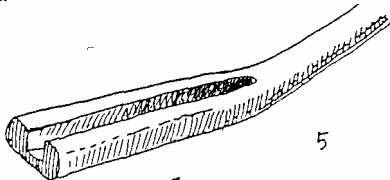

5

Fig.5. Now bend the wire up a little.

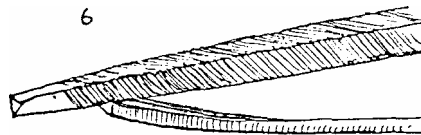

6

cutting edge is produced. The close-up shows what it will look like.

Fig.7. The bottom of the tool is now ground on an oil-stone until a sharp

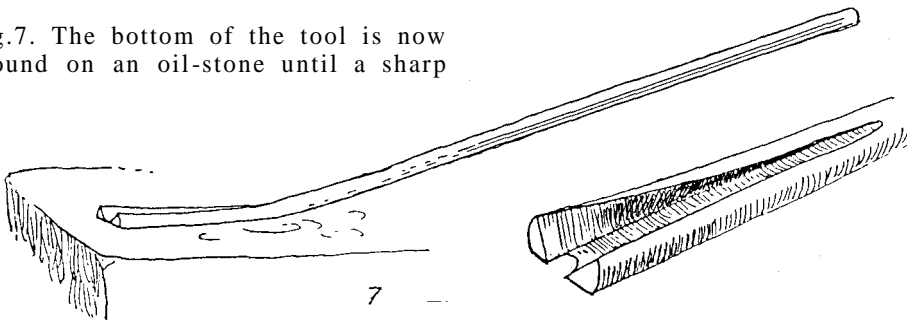

7

Fig.6. Use a three-cornered file to widen the mouth of the groove.

Fig.8. A piece of wood is chosen for a handle, a hole drilled in it and the wire pushed into place. It should be a good tight fit so that it will remain in position without needing to be glued.

The tool is now complete and ready for use.

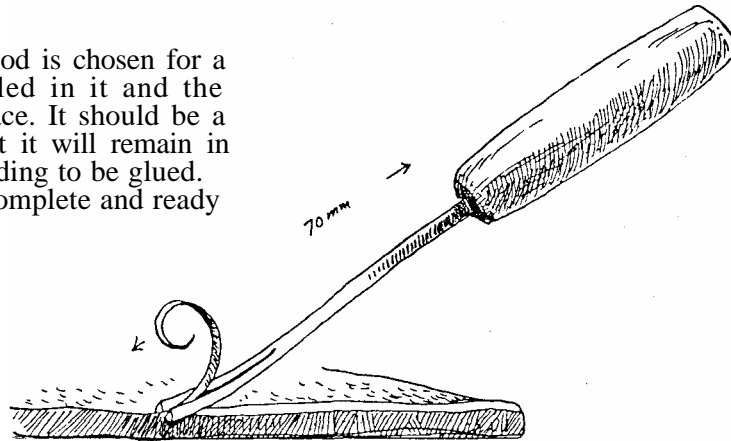

Another popular shave on the market is an American brand, but this type cannot be re-sharpened and has only a limited life.

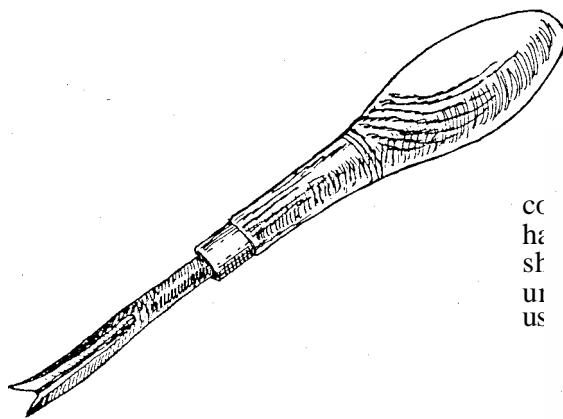

cc  
ha  
st  
us

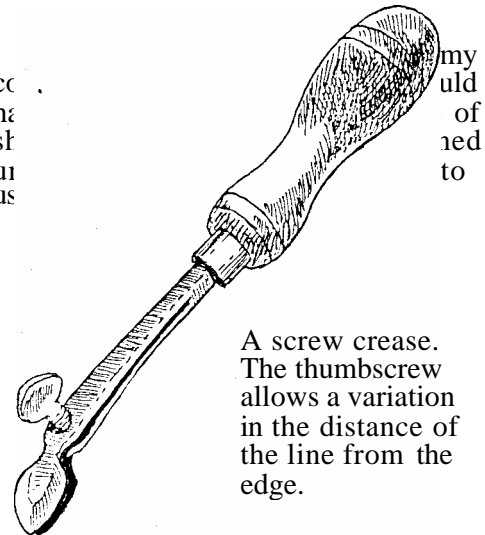

my  
uld  
of  
red  
to

## Edge Crease

If you look at any well made piece of saddlery you will notice a groove runs along the edge of all the strapping. This decorative touch gives a good finish to the article.

This same groove also has a practical application when stitching leather, as it provides a guide for the stitching, and the thread sits neatly into the groove and is less likely to get rubbed.

If you decide to buy a factory made crease then get the one called a screw crease. This type allows you to vary the distance of the groove from the edge of the leather.

A screw crease.  
The thumbscrew  
allows a variation  
in the distance of  
the line from the  
edge.

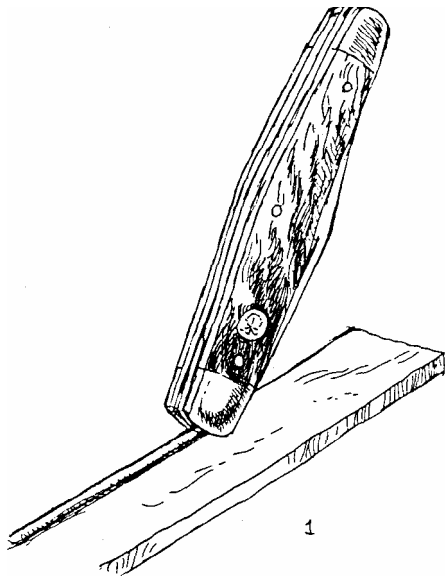
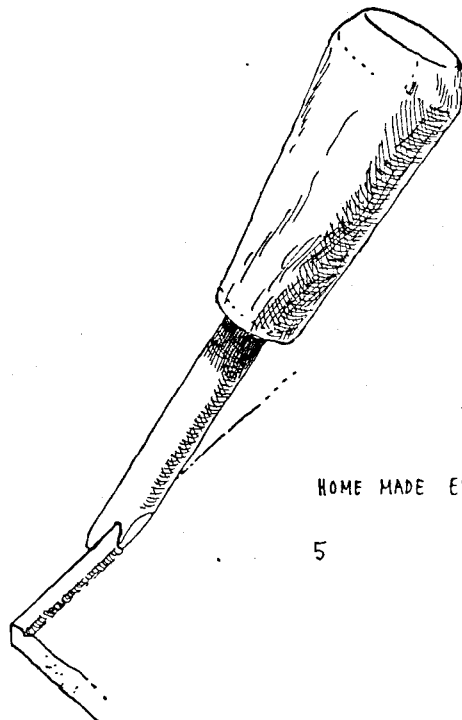
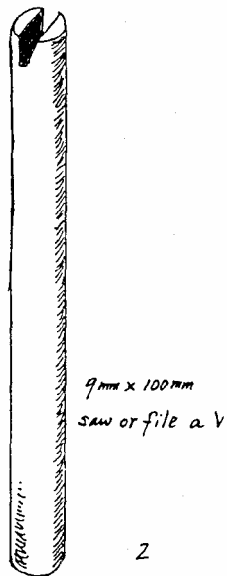

Fig.1. Many bushmen use the end of their penknife as an edge crease. With most brands of knives this works well, and is a simple answer to the problem.

However it is not difficult to make a simple edge crease.

Fig.2. Take a piece of mild steel rod of around 9mm in diameter and 100mm long.

Saw or file a V cut into the end. Note that one side of the cut is vertical, the other sloping.



HOME MADE EDGE CREASE

5



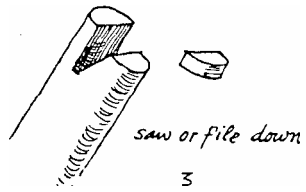

Fig.3. Saw or file the side shown so as to remove around 3mm of metal.

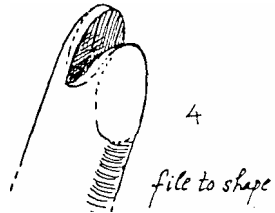

Fig.4. File the end to this shape. The right hand side should be sharp enough

to make a clean groove in the leather.

Fig.5. Fix on a handle and the tool is complete. The longer prong runs along the edge of the leather while the shorter one makes the groove.

Some people make two or three of these tools each of a slightly different size so as to be able to make a variety of grooves.

It is also possible to make one that will create a double line, but these are not so common.

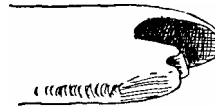

## Wooden Edge Crease

In the old days saddlers would make wooden edge creases. These were used to make grooves along the edges of heavy straps of harness leather.

This type of crease can be made very quickly. Select a scrap of hardwood big enough to be grasped in the hand and cut it as shown in the side view.

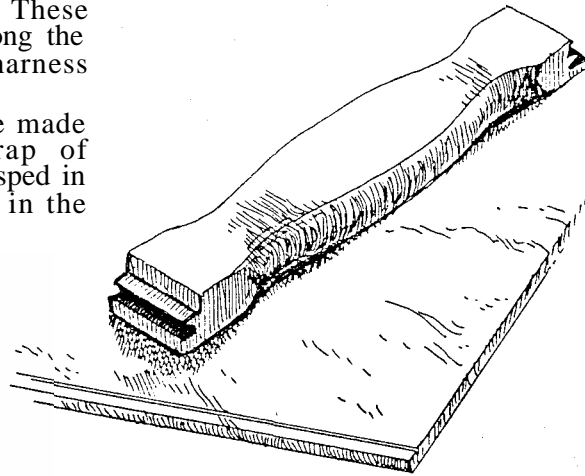
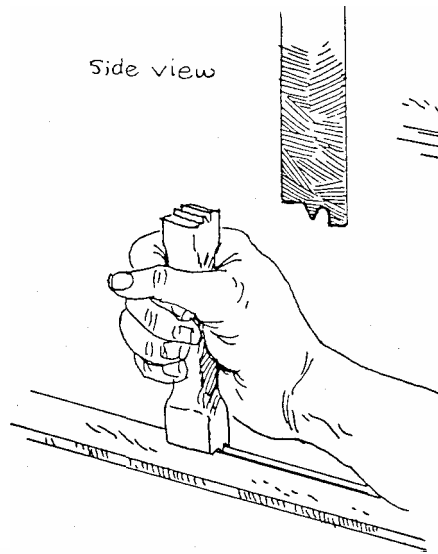

One part of the crease runs along the outer edge of the leather while the centre part makes the groove.

This type of crease is good for heavy leather because quite an amount of pressure can be exerted when using it.

The one in the sketch is a double-ender.

---

## Leather Crease

This simple tool is used to make decorative curves and patterns on leather. The saddle flaps on good quality stock saddles are decorated in this way. Cheaper saddles have a design pressed in mechanically.

When making handbags and suchlike the leather can be dampened before the crease is used.

For heavy leather such as saddle flaps the leather is not dampened, but instead the end of the crease is heated, often over a candle. It is then rubbed on a piece of beeswax and then applied to the leather. The crease does not have to be very hot, just as long as it will make a good mark on the leather.

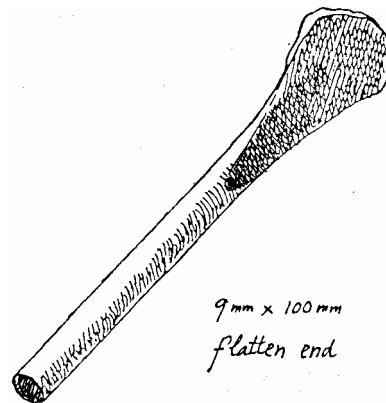

Fig.1. Take a piece of mild steel rod of around 9mm diameter and 100mm long. Flatten the end with a hammer. If the iron is soft you will be able to do this cold, if not the iron will have to be made red hot.

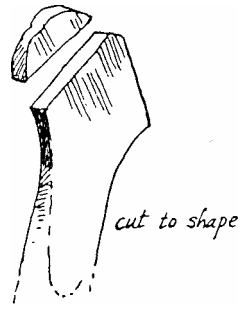

Fig.2. Use a hacksaw to cut it to shape.

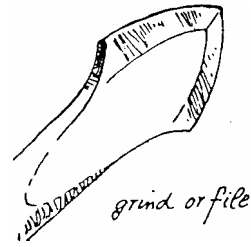

Fig.3. Grind or file an edge on it. The edge is rounded, not at all sharp. Use fine wet-and-dry paper to get the edge as smooth as possible.

Fig.4. The tool is used freehand, and the designs are kept simple.

Any piece of timber will make a handle, in this case I used a piece that had already been shaped.

On small jobs the leather is often dampened before using the crease instead of heating the crease and working on dry leather.

This is not practical on larger jobs such as saddle flaps, or on leather which stains when dampened.

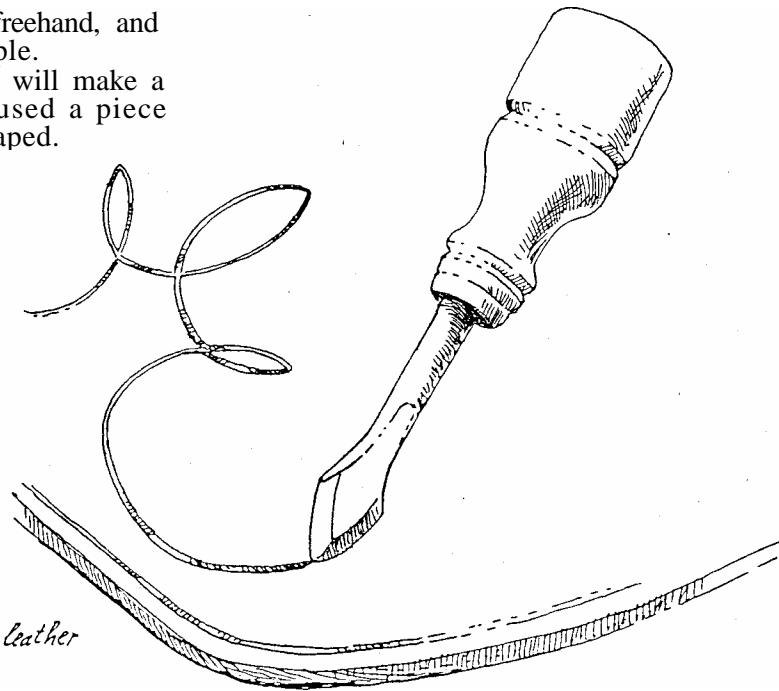

heat tool or dampen leather

## Racer

The various crease tools simply press a line into the leather, but the racer cuts a small strip out of the surface of the leather.

It can be used to make decorative lines, but this is not advisable as the leather is weakened. Its real use is to cut a line where stitching is to be done. The stitching will sit down snug in the groove and so be less liable to

be damaged or rubbed.

The best racer is a compass racer. This tool looks like a compass with a racer head. It can be opened out so as to cut a line at any given distance from the edge of the leather.

A compass racer would be too difficult to make, but it is possible to make a simple racer, if you have a little patience.

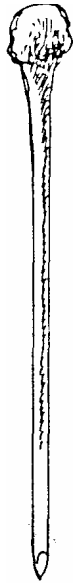

Take a good heavy 100mm nail and flatten the head. This can be done cold but it is better to heat it.

The outside shape does not matter at this stage, but the metal should be hammered until it has a smooth surface. It can also be rubbed down on a stone to get a good finish.

head.

This is a

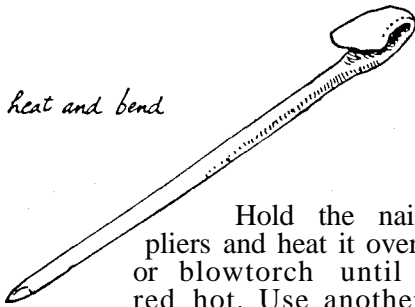
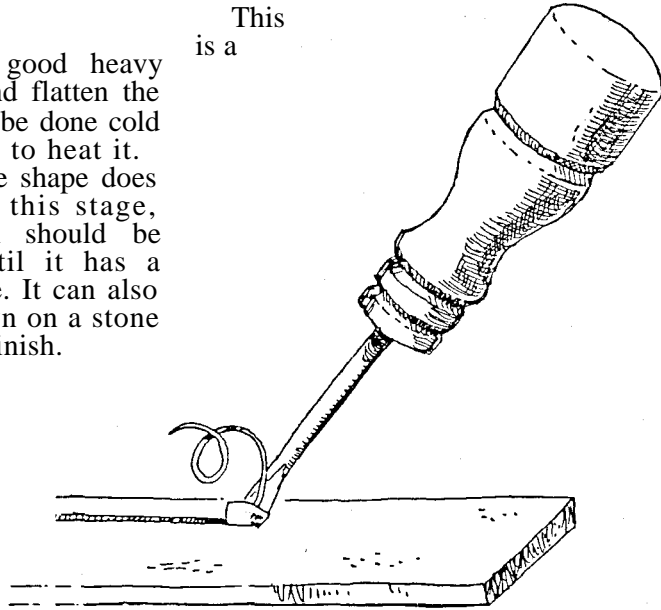

heat and bend

Hold the nail with pliers and heat it over a fire or blowtorch until it is red hot. Use another pair of pliers to bend the end over. Hammer it lightly until the gap is just under 2mm.

Use a fine file or grindstone to shape the head. This is the part of the job that needs patience. The cutting edge must be sharpened until it will cut a clean groove in leather.

Fix on a handle and the racer is complete.

When using it one finger runs along the edge of the leather as a guide while the others hold the tool.

HOME MADE RACER

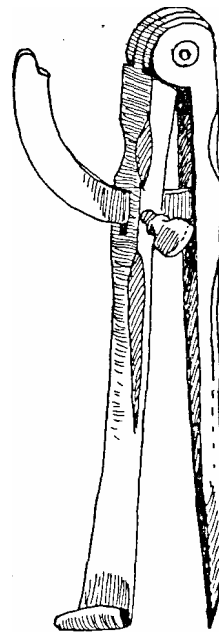

commercially made compass racer. The point on the right runs along the outer edge of the leather while the cutting head on the left cuts a groove.

These tools are quite expensive.

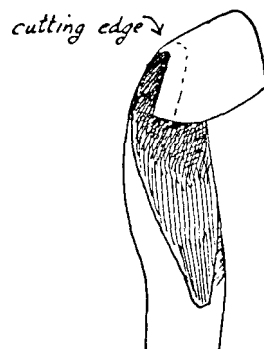

# Wheel

The marking wheel make a series of small marks on the surface of the leather, and these act as guides when stitching or punching holes.

They can be handmade by using cogwheels from old alarm clocks or other small machines, but the effort is hardly -worthwhile as they can be  $\therefore$  ought quite cheaply.

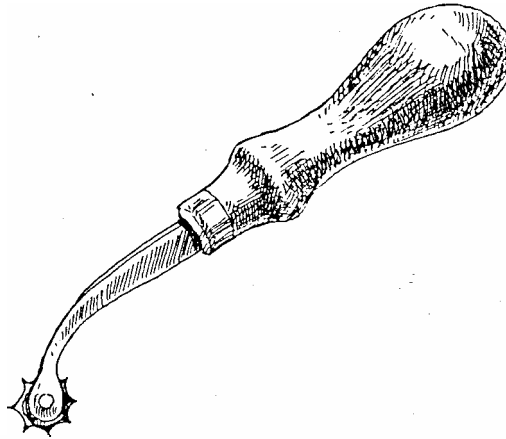

# Round Knife

The round knife is probably the saddler's most useful tool, and he will use it far more often than any other knife.

It is ideal for cutting off straps and skiving them, but it is also used for long cuts, including curves.

Most leather can be cut by just pushing the knife forward, but with heavy leather the knife is rocked back and forth, and moves forward in this way.

It is quite possible to make a round knife, but like all edge tools the problem is to find a piece of steel that will take and retain a razor sharp edge.

My son, while working in our saddlery business, made a round knife from a section of saw blade.

The making of a round knife is straightforward enough, the main thing to watch is that at no time during the cutting out and sharpening is the steel allowed to get hot enough to change colour.

If it does so it will lose its temper and be useless (unless you are clever enough to re-temper it, usually a job for a skilled blacksmith).

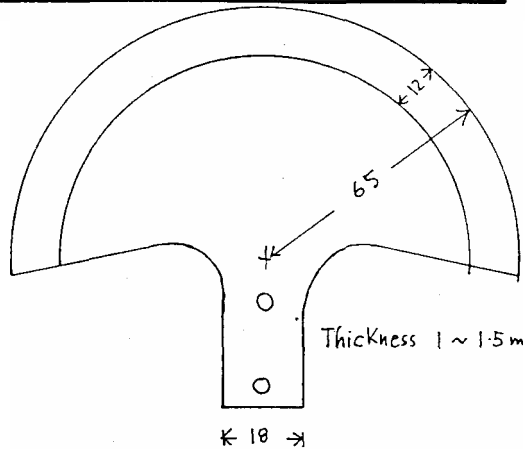
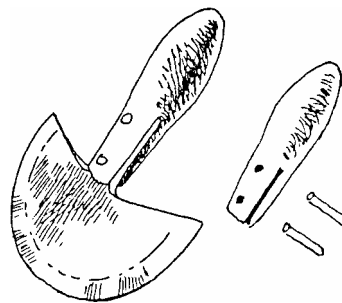
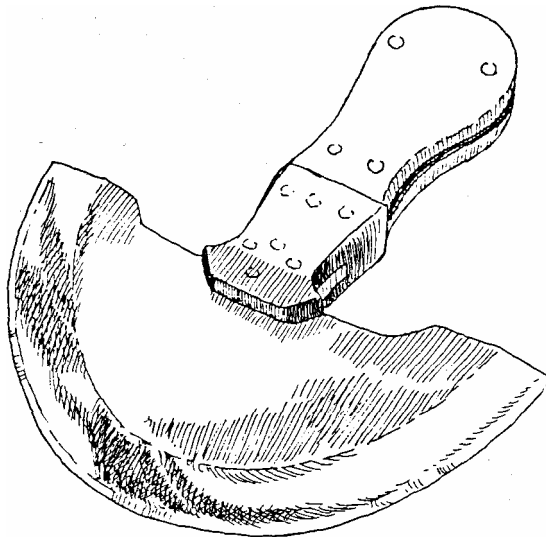

Fig.1. The dimensions can vary according to taste, these are average. Timber can be glued to each side to make a handle, but it is better to drill a couple of holes and put in a couple of pieces of metal rod, then hammer the ends so as to spread them.

This must be done with care so that the wood will not split. Copper rivets and roves, such as are used in boat building, can also be used and will lessen the chance of splitting.





This round knife was handmade for me by the late George Lee Sye, one of Australia's greatest knife makers.

This is an ordinary commercially made round knife.

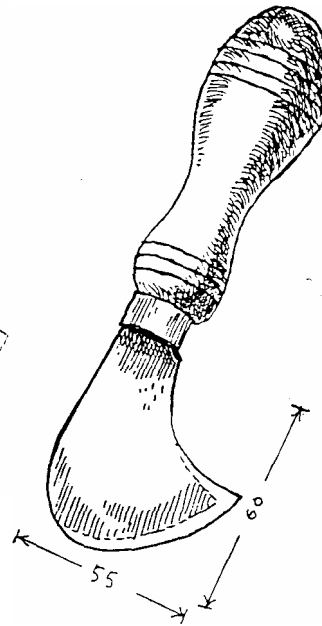
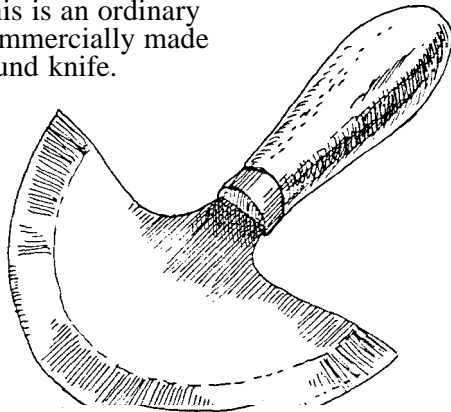

This is a head knife, a tool that was once a standard part of a saddler's tool kit but which today is almost impossible to obtain.

It was used for cutting small curves, slots in leather, and any other job which was difficult for the round knife.

It would be possible to make such a knife by hand, and it would be a useful item for any serious leatherworker.

A lacing fid is required when making Turk's-heads or finishing up plaited belts. Its purpose is to simply open up a gap in previously plaited work.

## Lacing Fid

For rope work the fid is round but a flattened one is used for leather lace. It is made by grinding a flat onto either side of a scrap of 6mm diameter mild steel.

A fid can also be made from a small bone.

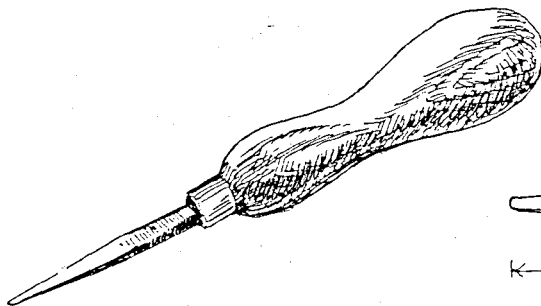

204

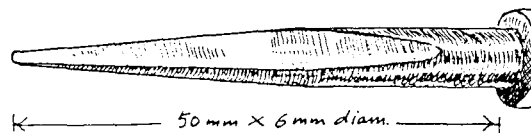

# Awl

A saddler's awl is essential when sewing harness. Although it is a simple job to make one this is not a tool that I would recommend you to make unless it is a matter of necessity.

This is because a saddler's awl needs to be very well tempered in order to keep a sharp edge, and the correct tempering is usually beyond the skill of the home craftsman.

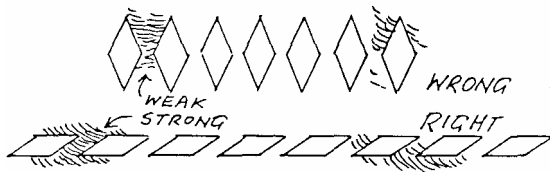

There is a special technique needed when using an awl. It is held so that it will make a row of holes as shown in the lower diagram. There is a strong strip of leather between each hole.

If the diamond shaped holes are positioned as shown in the top drawing there is a weak spot between each hole, and the leather may tear when being sewn.

A factory made awl, the blade can be removed by unscrewing the head.

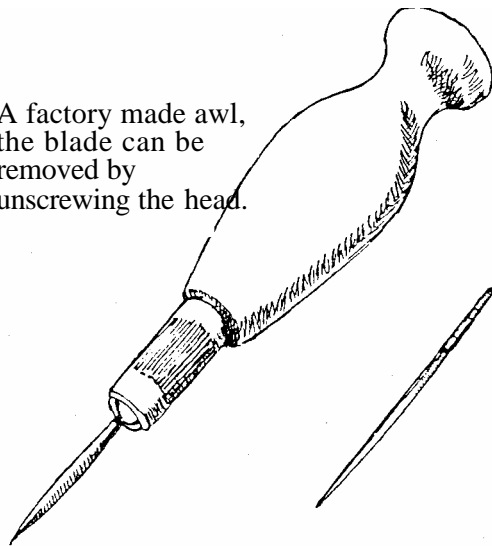

SEWING AWL

However people in the bush often have to make their own awls, so here is how to do it.

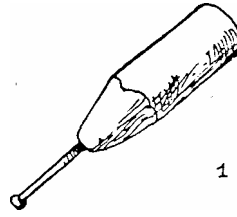
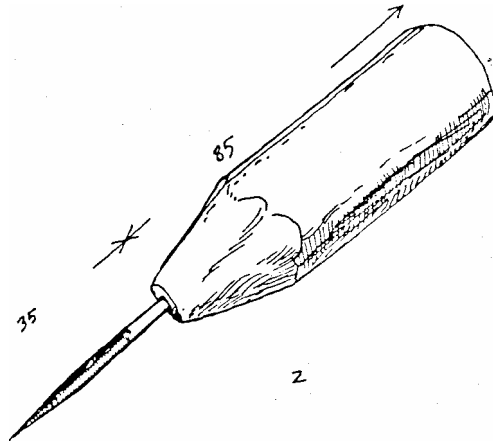
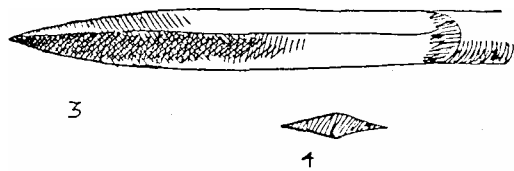

Fig.1. Hammer a nail into a piece of wood that has been shaped as a



handle.

Fig.2. Sharpen the nail. If you want a wider awl then hammer the nail a



little to widen it before sharpening.

Figs 3 & 4. This shows the awl from one side and also the cross section. The outer edges must be made extremely sharp.

Heat it over a blowtorch or flame until it glows a pale straw colour. This will take place at around 430 degrees Fahrenheit, the correct temperature for tempering lancets.

Plunge it into water, sharpen it again and with luck you will have a usable awl. I have managed to get by with such an awl on various occasions, but have always been pleased to replace them with proper awl blades as soon as possible.

# Stitching Awl

This tool is used by leatherworkers, especially street cobblers, in many parts of Asia. Craft shops here sell a much more elaborate tool, but one that only produces the same stitch as this simple device.

This stitch can be used for all sorts of general leatherwork except harness. Harness must always be stitched with two needles in the traditional manner as lives may depend upon it.

This stitching awl is quite easy to make. Its main use is with leather, but it can also be used with canvas if the edges are left blunt.

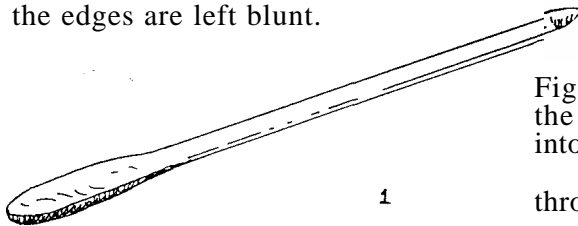

Fig.1. Take an 80mm length of fencing wire or a nail and flatten the end with a hammer.

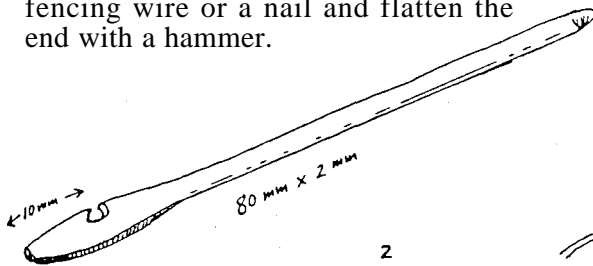

Fig.2. Use a hacksaw or a very small file and make a couple of cuts to create a hole as shown.

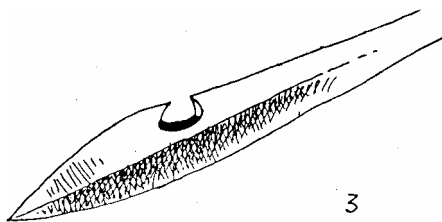

Fig.3. Now grind the edge to the shape shown and sharpen it well.

If you heat it and then plunge it into water you can also harden the metal, but you may also make it too brittle, so it is a matter of choice.

Heat it over a blowtorch until it

glows a pale straw colour. This will take place at around 430 degrees Fahrenheit, the correct temperature for tempering lancets.

Plunge it into water and then give it another touch-up on the oilstone.

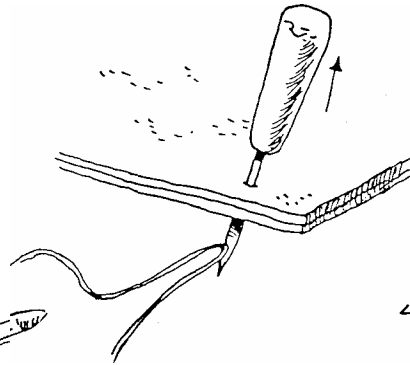

Fig.4. Use the awl to push a hole in the leather and then hook the thread into the slot.

Pull upwards to bring the thread through the leather.

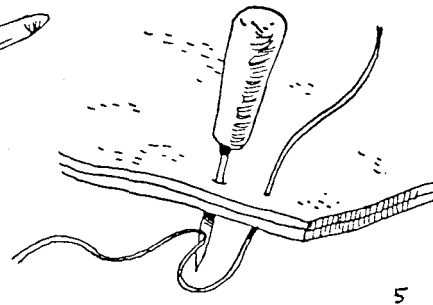

Fig.5. Make a second hole and again put the thread into the loop and pull it upwards.

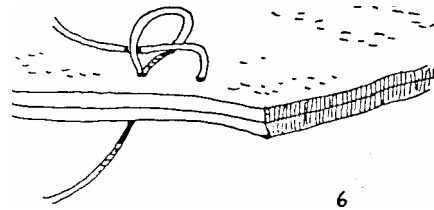

Fig.6. Put the top thread through the loop that has been formed and then pull both threads tight to form the stitch.



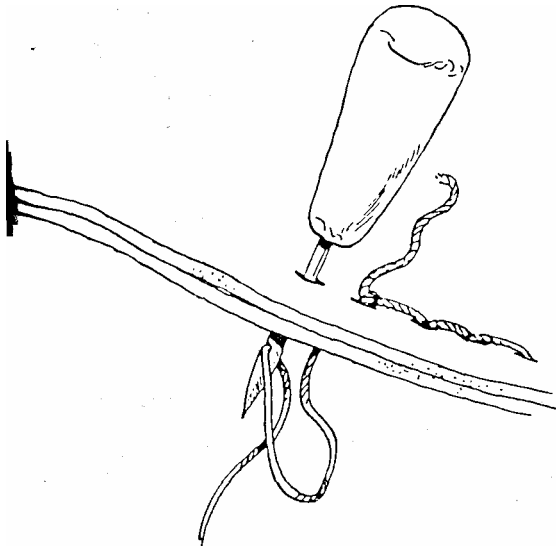
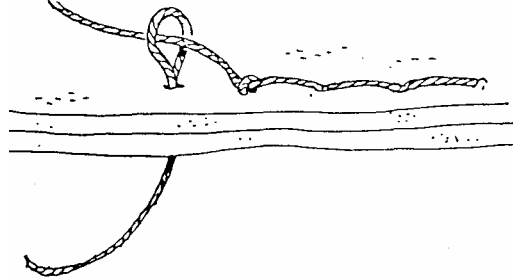

Fig.7. The work progresses in the same way. Make a hole and pull the thread up through the leather.

Fig.8. Put the top thread through the loop and pull both threads tight.

In light leather quite good speeds can be attained using this form of stitching.



## Bone Smoother

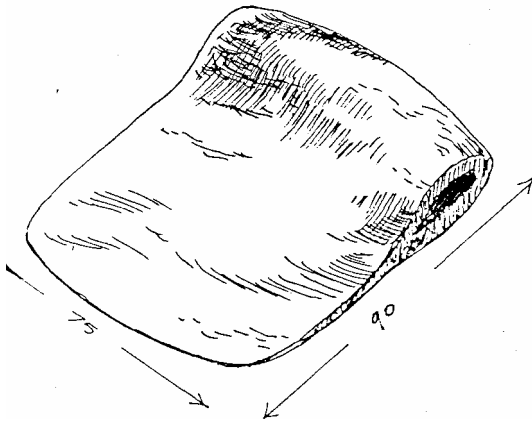

A bone can be used to get a good edge on belts, especially belts made from good heavy leather.

The edge of the leather is moistened, not soaked, and then rubbed briskly with the bone.

When dry it can then be waxed and rubbed with a piece of coarse canvas, or again polished with the bone.

The bone is also used when doing moulded leather work. When saddlers are putting the seat on a saddle they are faced with the problem of a mass of wrinkles where the leather comes over the back of the saddle seat.

By striking the dampened leather as shown in the sketch the wrinkles

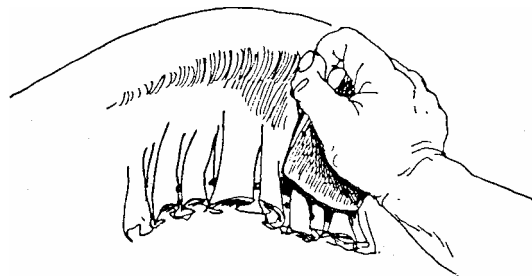

can be slowly worked out of the leather until it becomes quite smooth.

A heavy piece of perspex can be shaped to do the same job.

A butcher advised me not to boil bones to remove the scraps of meat that cling to them as he claimed that this weakened the bone. Instead they should be placed outside where ants can clean them up.

The bone should then be sanded down with fine paper until it is silky smooth.

The bone does not have to be the dimensions shown here, just so long as it will comfortably sit in the hand.

For smoothing belt edges a rib

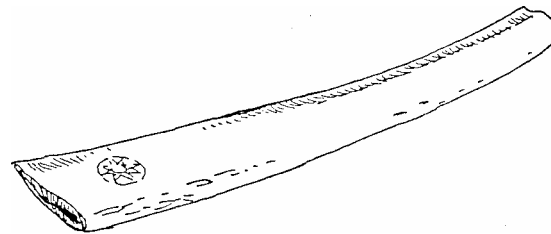

bone can be used.

## MULTIPLE SLIT PUNCH

Early in 1984 a Multiple slit punch in the shape of pliers came into our leather shop in a batch of tools from Japan. This tool has a very good action and cuts three slits at once.

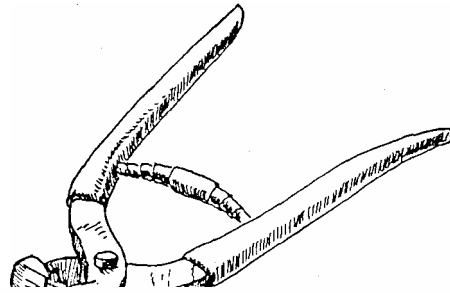

---

## Edge Polishing Iron

A lot of otherwise well made belts are spoiled by having rough, hairy edges.

A neat finish is achieved by first using an edge crease to make an indented line close to the edge. Next an edge shave (called by Americans and edge beveler) is used to shave off a fine strip of leather and round the edges slightly.

For most leatherworkers this is enough, but old time saddlers then used another tool, called an edge polishing iron, to get a fine smooth edge.

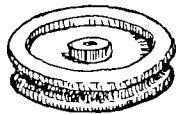

Today a plastic tool called an edge slicker is available, and while this certainly does help improve the final finish it cannot do as good a job as the iron because it cannot be heated.

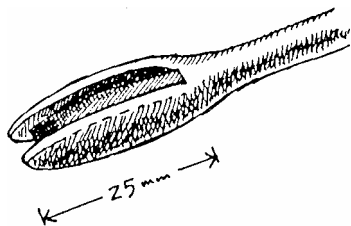

The head of the iron has a groove in it so that it fits around the edge of the leather.

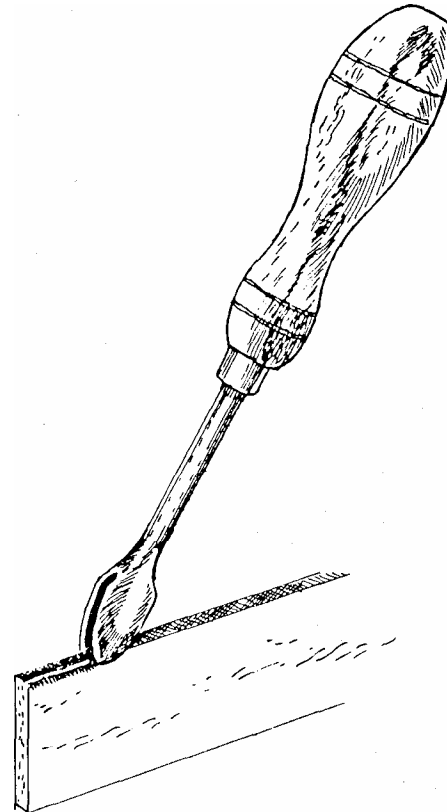

The head of the tool is heated, then dipped in wax, and rubbed on the edge of the leather while still hot.

An ordinary candle can be used, with a lump of beeswax standing next to it, but an even better idea is to use one of the very large candles that are available today.

As these melt a pool of hot wax forms around the base of the wick, and the iron can be dipped into this.

We use beeswax in our saddlery business for rubbing on thread. I use this to make my own large candles, melting it into margarine containers.

A length of wire is pushed through the centre and some string threaded through. Proper candlewick would be even better, as the string smoulders after the flame has been blown out, and the end must be pinched off or dipped into the still melted wax pool.

Polishing irons are still available, but are often hard to obtain. It is quite possible to make an effective homemade iron.

A scrap of mild steel of around 6mm diameter is used, or whatever comes to hand, and the end hammered to a slight curve.

A small file is used to shape the groove. The bought tool has a groove on either side of the head, but only one side is necessary on a homemade tool.

Fix on a wooden handle as the tool gets hot during use.

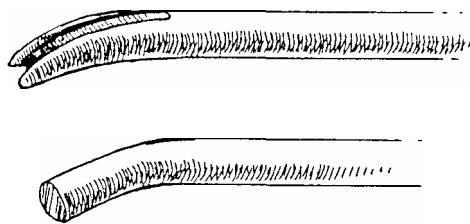
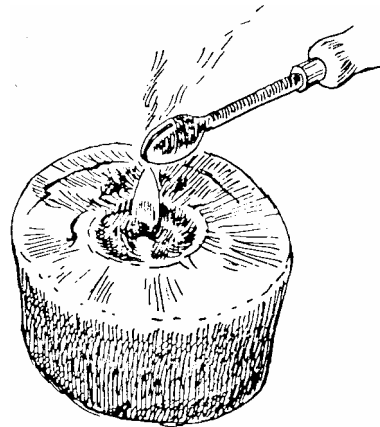



---



---

## LACE NEEDLES

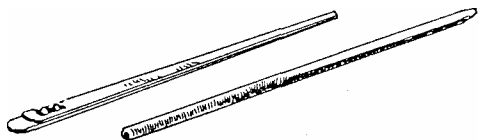
Needles are needed for complex work, although in a pinch even these can be dispensed with. Tim Chorley of Galston, NSW, told me that when caught without a needle he uses a couple of drops of quickdrying glue to stiffen the point of the lace or thread, and so aids the sewing.



There are two types of needle in common use, a flat one made from two pieces of metal and a cylindrical one.

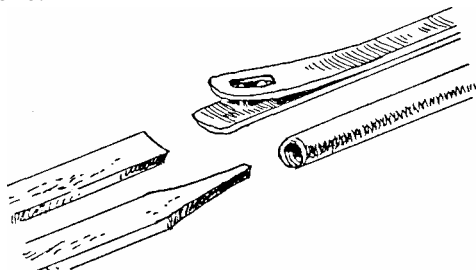

The flat needle has two small hooks in it, and opens as shown in the top sketch to take the lace.

The cylindrical needle has a thread inside its hollow head, and the lace is cut to a point and then threaded in.

Neither type can be pulled with any force, and this is why the lacing fid is needed, to open a pathway for the needle.

I much prefer the cylindrical needle, because it seems to go through the holes much easier. The main problem with these needles is that if you do use too much force the point of the lace will break off inside the needle.

Any attempt to dig out the leather will damage the thread and spoil the needle. Hold a lighted match under the needle and the leather will slowly spiral its way out.



# 10 ROLLING A THREAD

In order to properly sew leather you must first learn to roll your own thread and then learn to sew with two needles and a sewing awl.

The saddler makes his thread by taking a number of strands of a special thin thread, rolling them together and coating them with wax to make the thickness of thread he requires for each job.

The completed thread is about 2 metres long and has a long taper at each end. The taper is extremely important.

The great secret in thread making is in the breaking of the thread to create the longest possible taper.

The thread used by saddlers comes in two grades, "Common No 2" (sometimes simply labelled "Best Common") and "No 15". No 15 is thinner than No 2 but for all practical purposes this does not affect the saddler who simply takes sufficient number of strands for the job.

He could, if he wished, use either of

them to make a cord as thick as his thumb. No 2 is generally used for saddle work and the most commonly used thread is one made by rolling together 3 lengths of No 2.

No 15 is a little finer and three strands of this are rolled together to make a thread for finer work, or four strands to make the equivalent of three strands of No 2.

**TO MAKE THE THREAD.** The thread comes in a ball. Two ends should be visible, one on the outside of the ball and one on the inside. Do not unwrap the outside thread but pull out the one that is in the hole in the centre of the ball. Lay it across the palm so that the last 150mm hangs out on the lower side of the hand.

(Before going any further I should like to explain two things. First saddlers, being individuals, develop all sorts of different ways of holding the thread, but the one described here is probably the most convenient. Secondly, left handed people, as always, must reverse all the directions).

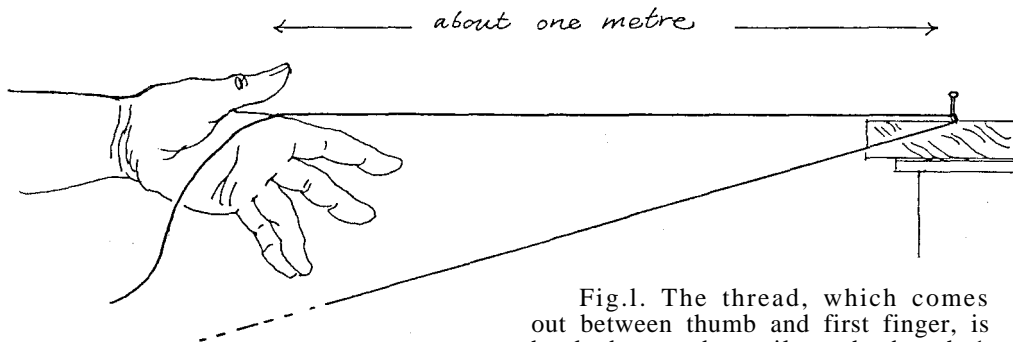

Fig.1. The thread, which comes out between thumb and first finger, is hooked around a nail on the bench 1 metre away. The thread goes from your left hand to the left side of the nail, around it and back to your hand.

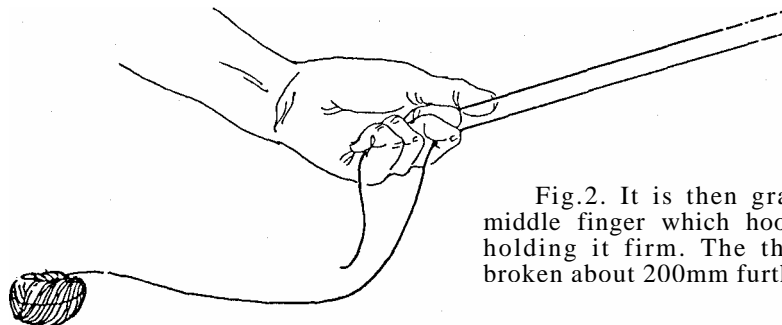

Fig.2. It is then grasped by the middle finger which hooks around it holding it firm. The thread is now broken about 200mm further on.

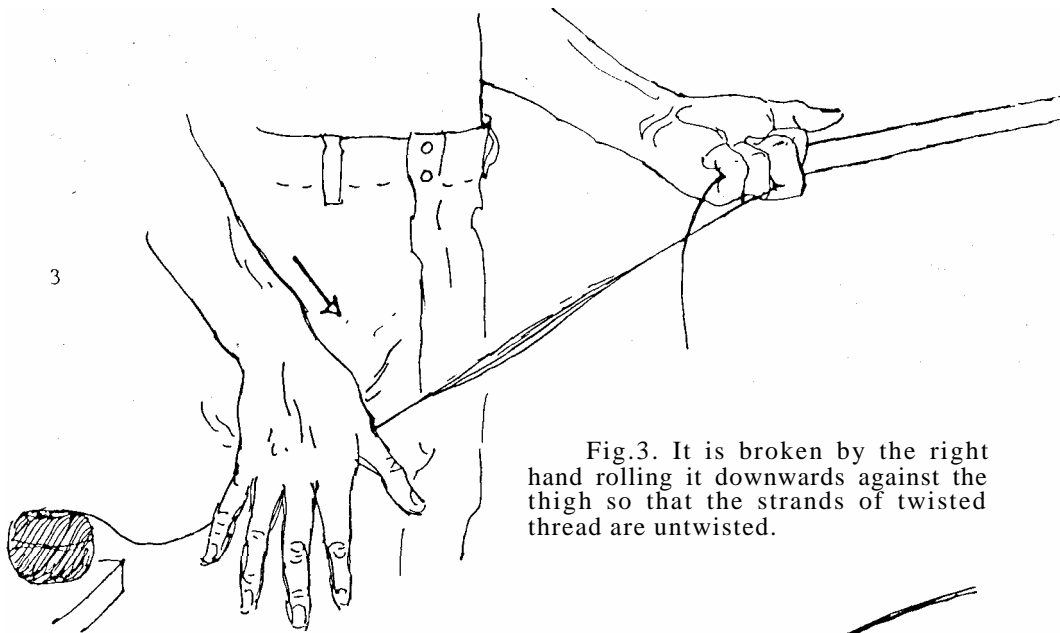

Fig.3. It is broken by the right hand rolling it downwards against the thigh so that the strands of twisted thread are untwisted.



Fig.4. The thread does not come apart with a pop, or snap, or with any pressure at all. In the hand of a saddler it seems to float apart leaving the ends long, silky and tapered.

Only practice will bring about this magic. The secret is to know exactly when the strands of the thread are exactly unrolled and apply a gentle pull at this point. The common mistake is to roll too much so that the thread passes this point and is rolled in the reverse direction. The saddler rubs his hand down his thigh only once to get the thread broken.

Again I must stress that the purpose of this is to create a long taper. A roll down the thigh accompanied by a sharp jerk will break the thread each time but will not create a usable taper. You might as well use a pair of scissors.

It is also impossible to create a long taper on a piece of machine made thread, though plenty of lazy leatherworkers have tried.

The saddler always rolls his own.

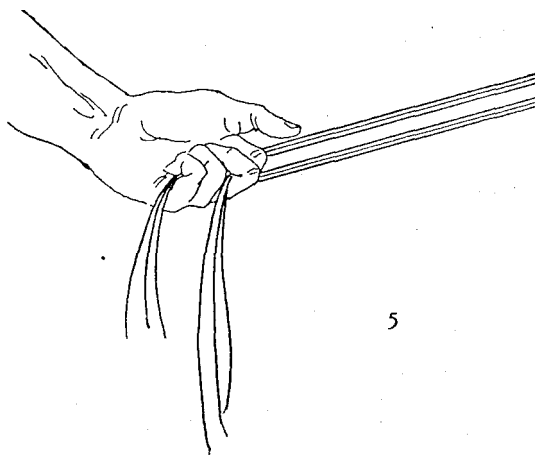

Fig.5. Three lengths of thread are taken from the palm of the hand around the nail and back to the middle finger. More are taken if heavy work is being done and a thick thread is needed.

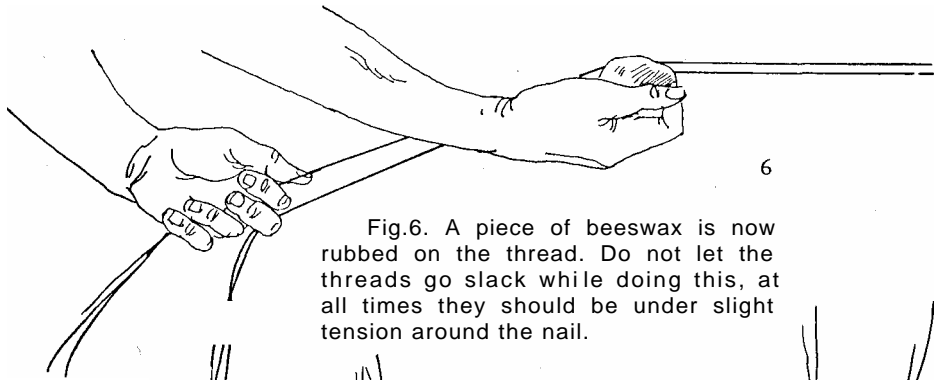

Fig.6. A piece of beeswax is now rubbed on the thread. Do not let the threads go slack while doing this, at all times they should be under slight tension around the nail.

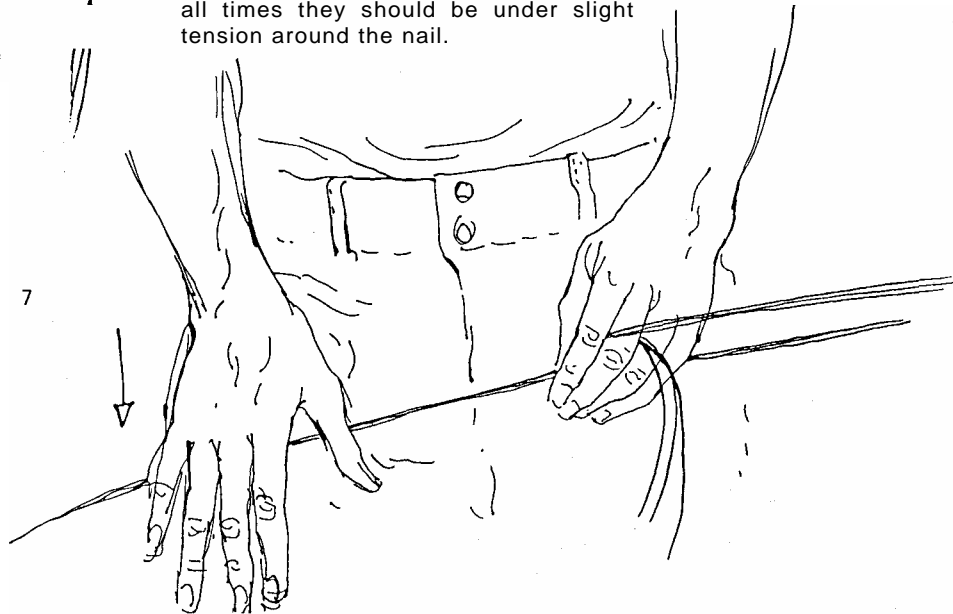
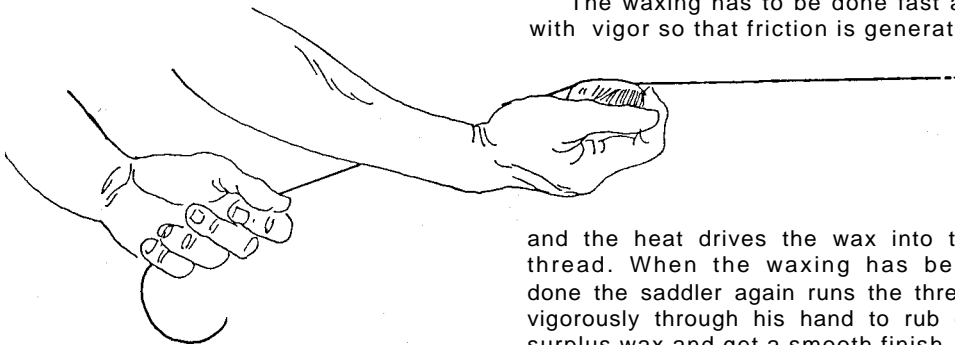

Fig.7. The thread is now rolled down the thigh. Try and avoid crouching like a nervous kangaroo while doing this. The saddler remains upright and relaxed.

Fig.8. When the thread has been rolled wax is again rubbed along the whole length of it. The amount of rolling required can be judged by looking at the twist in any manufactured rope. Most beginners do not roll their threads enough.

The waxing has to be done fast and with vigor so that friction is generated



and the heat drives the wax into the thread. When the waxing has been done the saddler again runs the thread vigorously through his hand to rub off surplus wax and get a smooth finish.

Rather than use the bare hands you might find it better to use a piece of bag or coarse canvas.

## SINGLE ENDED THREAD

Fig.9. Most saddlery work is done with two needles, but there are certain jobs, such as sewing the panel to the seat, where only a single needle is used. In this case the thread need only have a taper at one end.

To make this type of thread pass the strands around the nail as before and wax them, but this time roll them

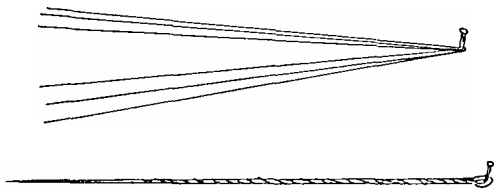

all together. In this case instead of making a long 3 strand thread it is roiled into a thread of 6 strands.

Any number of strands may be rolled like this to make quite heavy cords.



Fig.10. When the thread is lifted from the nail you will find that there is a loop in the end as shown. This can be utilized in certain jobs by passing the needle through it after the first stitch to anchor the thread.

Otherwise the normal way to hold the thread is to tie a simple knot in the end as shown.

## SEWING

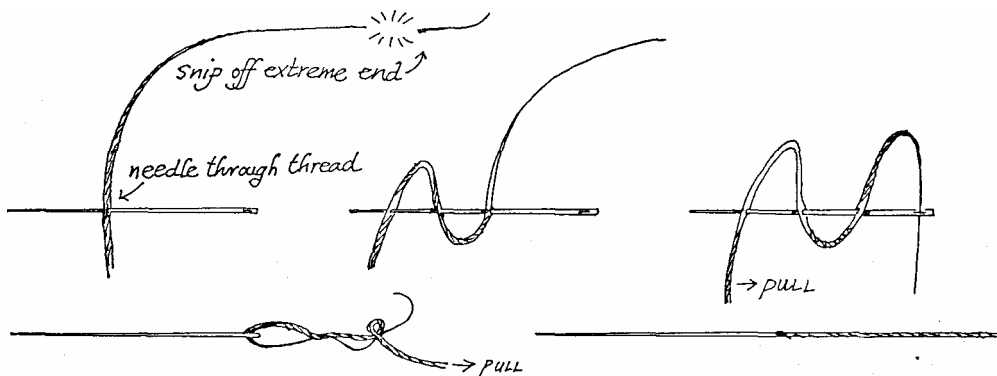

Saddlery work is sewn with harness needles. These are similar to ordinary needles but have blunt points. The reason for the blunt points will become obvious when you ram one under your fingernail.

If they are not available you can make your own by simply blunting ordinary needles. The points are not needed as the holes in the leather are made before the needle is used.

Fig.11. The needle must be firmly fixed to the thread. Push the needle through the middle of the thread as shown in the first sketch, and do it as close to the end as possible.

The end of the thread will terminate with a very fine whisker and it is a good idea to just trim this very end to make it easier when threading the needle.

Continue pushing the needle through the thread two or three times.

Thread the needle. When this is done begin pulling the thread so that it slides up the needle towards the eye. Keep pulling and it will slip right off the end of the needle. You will now find that the thread is locked on to the needle.

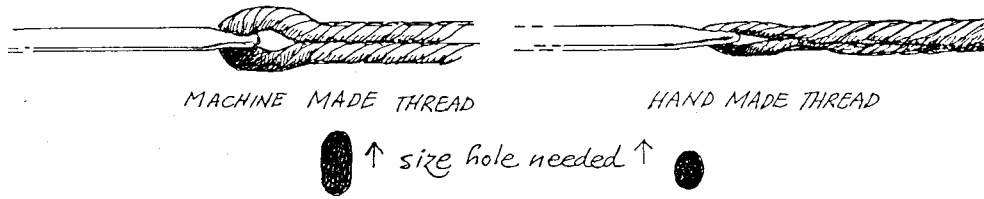

Fig.12. Having now threaded the harness needle onto the tapered thread I will explain why the saddler goes to all this trouble instead of just cutting a piece from a roll of machine made thread.

The reason is quite simple and is explained in the left sketch. The machine made thread makes a double thickness where it goes through the eye of the needle. In order to get this through the leather you would need to make a large hole, and later the thread would be loose in the hole. On the other hand the hand-made

tapered thread puts the smallest possible bulk through the eye of the needle. This means that a smaller hole is needed and the thread remains always firm in the leather.

It is actually quicker to make a thread and sew with it than it is to cut off a length of machine made thread and sew with it. The reason is that a well tapered thread will pass through the leather with ease but the machine made thread will be forever jamming and need pulling through with pliers because of the double thickness at the eye.

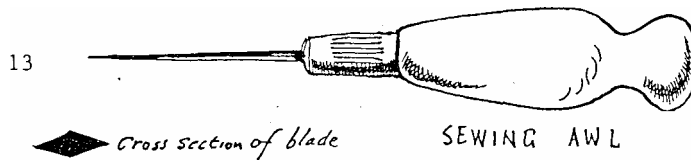

Fig.13. A sewing awl is needed to make holes in the leather for the needles to pass through. The blade has a diamond cross section. When bought the blades are not usually very sharp and it is a good idea to touch up the edges with a file. The blade should go through the leather without having to push too hard.

In the bush an awl can be made by hammering a nail into a piece of wood

and filing it to the correct shape, but this will not hold its edge for long.

You should have two or three different size awl blades to suit different jobs. You should not need pliers to pull the needle through, if there are problems like this then either the thread has not been tapered well enough or you are using too small an awl blade.

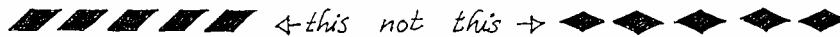

Fig.14. The awl blade makes a diamond shaped hole in the leather. Hold the blade at an angle so that the holes are placed as shown on the left. This gives the maximum strength of leather between each hole. If the blade is held to make holes as shown on the right there is a weak spot between each stitch.



15

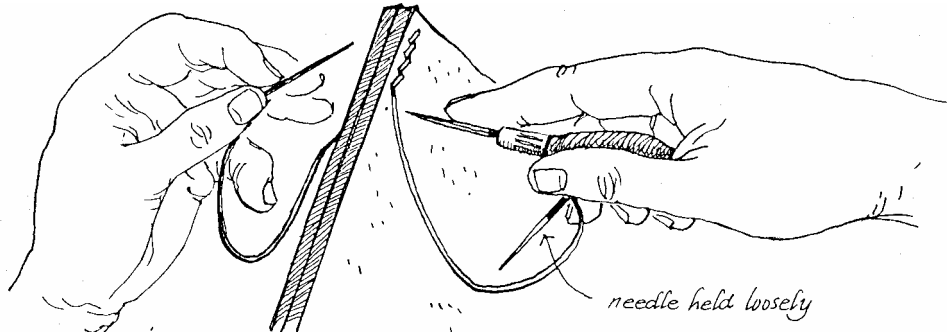

Fig.15. To begin stitching place the job in the saddler's clamp. In my book Australian Traditional Bush Crafts there are directions for making a good home made clamp.

The clamp is held between the knees, it is not held upright but leans over to the left so that you see only

one side of the job, and this is always the best side.

A hole is made with the awl, one needle passed through and sewing begins. In your left hand you hold one needle, and in your right hand the sewing awl and the other needle. The needles are held at all times.

Push the awl through the leather.

16

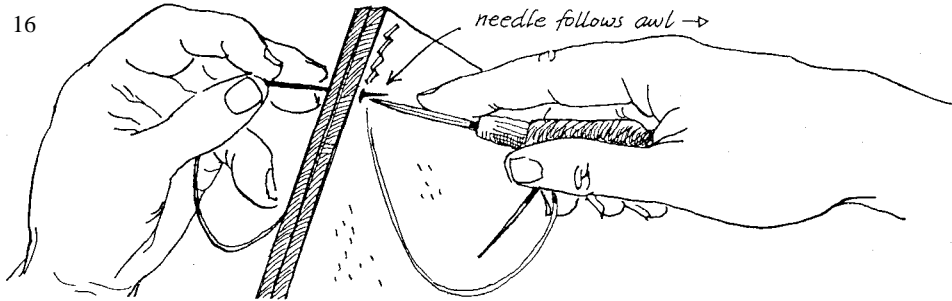

Fig.16. The needle in the left hand rests on the top of the awl blade for

guidance and follows the awl blade through as it is withdrawn from the leather.

17

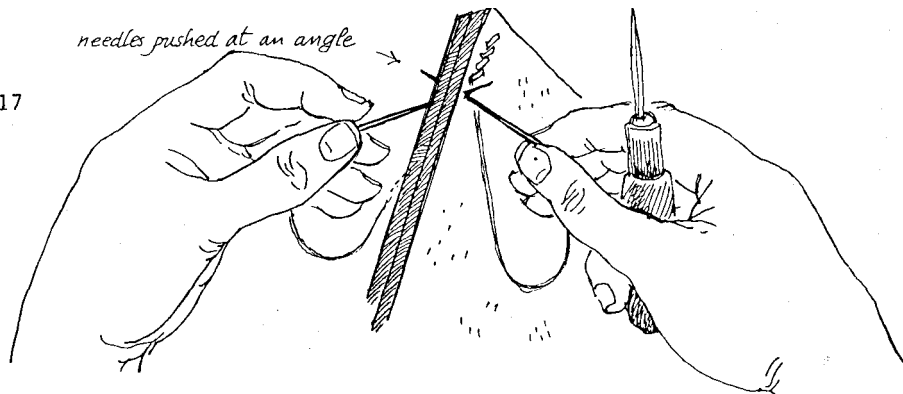
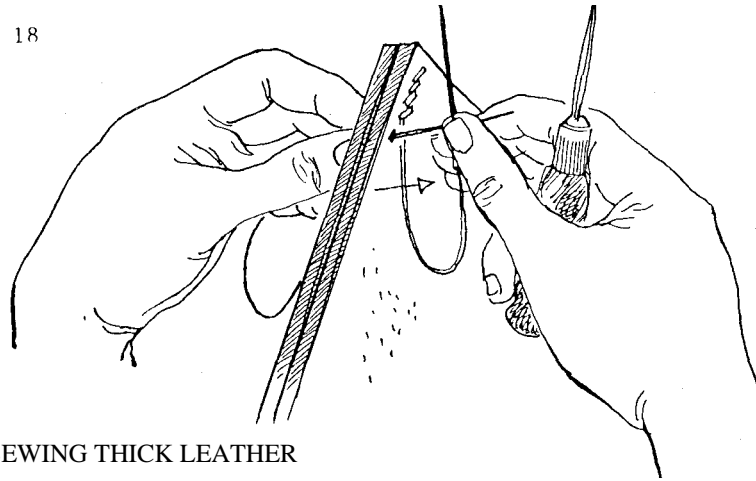

Fig.17. Now the needle in the right hand is also pushed through the hole. The needles are pushed through at an angle to avoid pushing the needle under ones fingernail.

The needles are pulled out and the stitch is complete.

Notice that in this sketch the

sewing is coming towards the saddler. There is a great deal of argument amongst saddlers about this, some insist on sewing toward themselves and others always sew away. For a beginner I would suggest that you can make neater stitches by sewing towards yourself.



SEWING THICK LEATHER

Fig.18. It sometimes happens when sewing thick leather that it is too difficult to pass both needles through the leather at the one time. In this case make the awl hole and bring the left needle through. Cross the needles as shown with the right hand needle behind the left hand needle and pull the left hand needle through.

Fig.19. Once it is clear of the leather push the right hand needle into the hole. As you do this give the left hand thread a little tug with the left hand to make sure that the right hand needle has not perforated the thread, then pull the needle through.

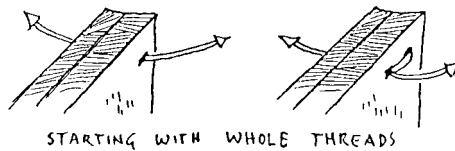
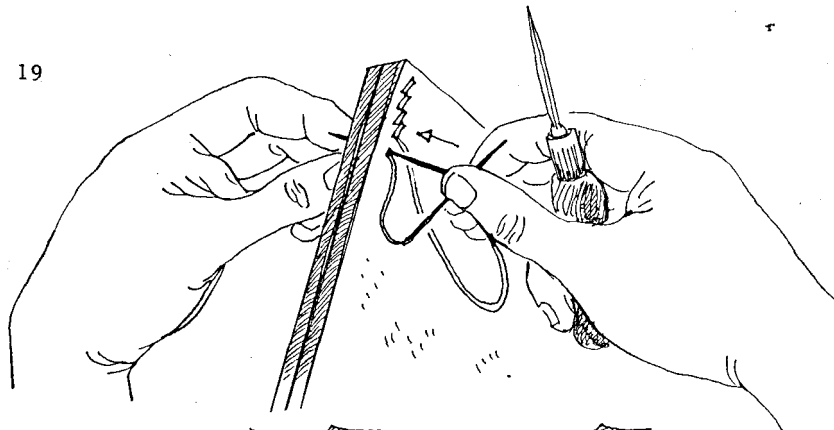

STARTING WITH WHOLE THREADS

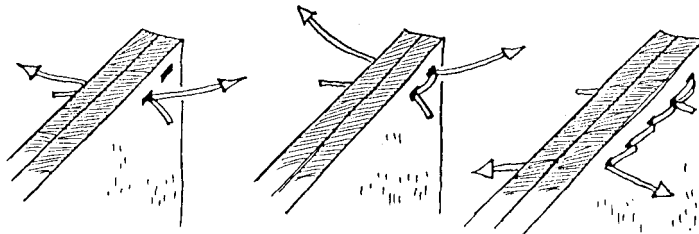

STARTING WITH CUT THREADS

Fig.20. The top sketches show how to begin sewing using a newly made thread. However not all jobs will use up a whole length of thread and so you will end up with a number of lengths of cut thread, each with a needle on one end. These are used as

shown in the bottom row of sketches.

Begin sewing on the second or even the third hole down, sew away from yourself for a stitch and then come back and continue. This will lock the thread permanently in place.

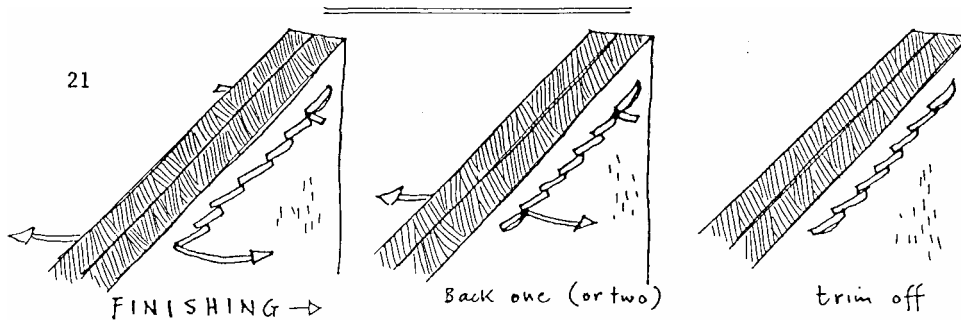

Fig.21. To complete sewing go back one or two stitches and cut off flush. This is all that is needed.

#### ANOTHER WAY OF BEGINNING

Fig.22. This is a common way of starting and finishing when sewing bridles and similar work. It is easier than sewing twice through the one

hole. Short lengths of thread can be used for this work, the ends left sticking out at the beginning and trimmed off later.

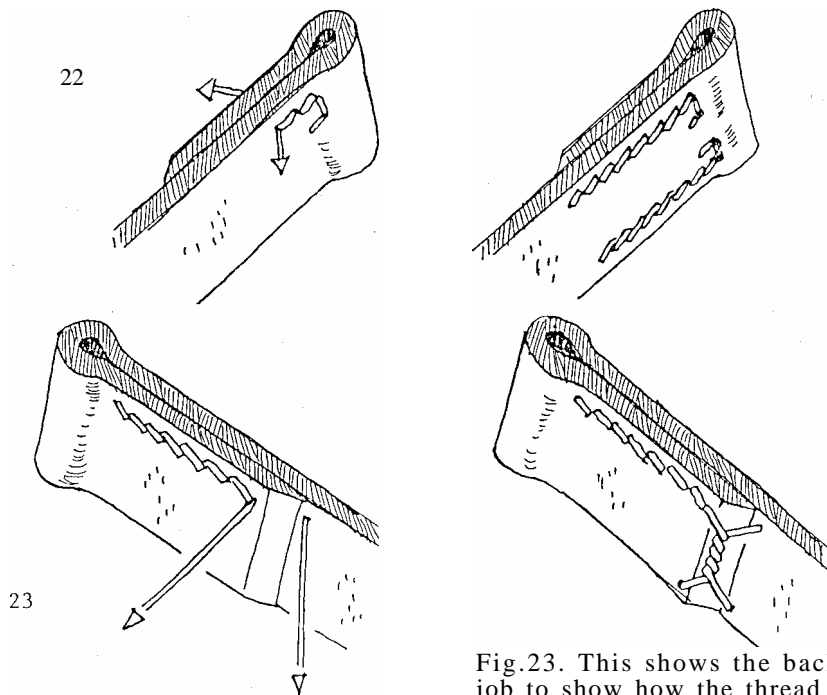
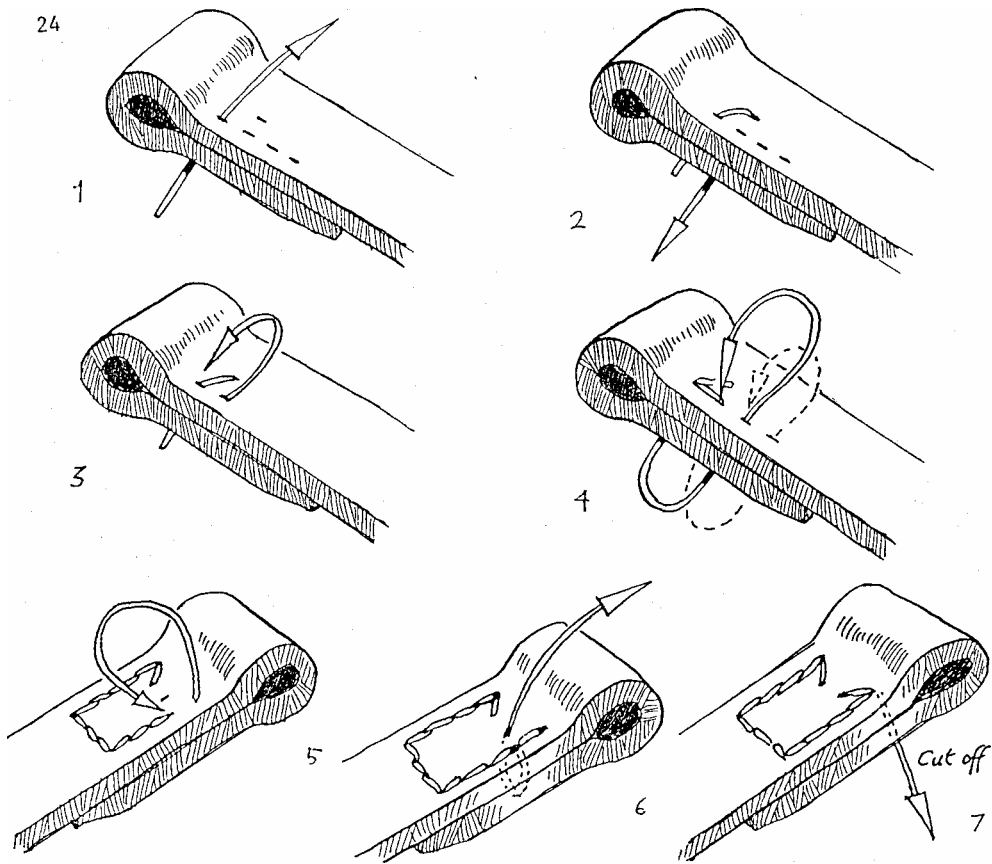

Fig.23. This shows the back of the job to show how the thread is taken from one side to the other. A row of stitches across would weaken the leather so it is twisted as shown.



BACK STITCHING WITH ONE NEEDLE

Fig.24. It is sometimes convenient to sew with only one needle, and in that case this technique is used.

However it uses one third more thread and the back of the job does not look as neat.

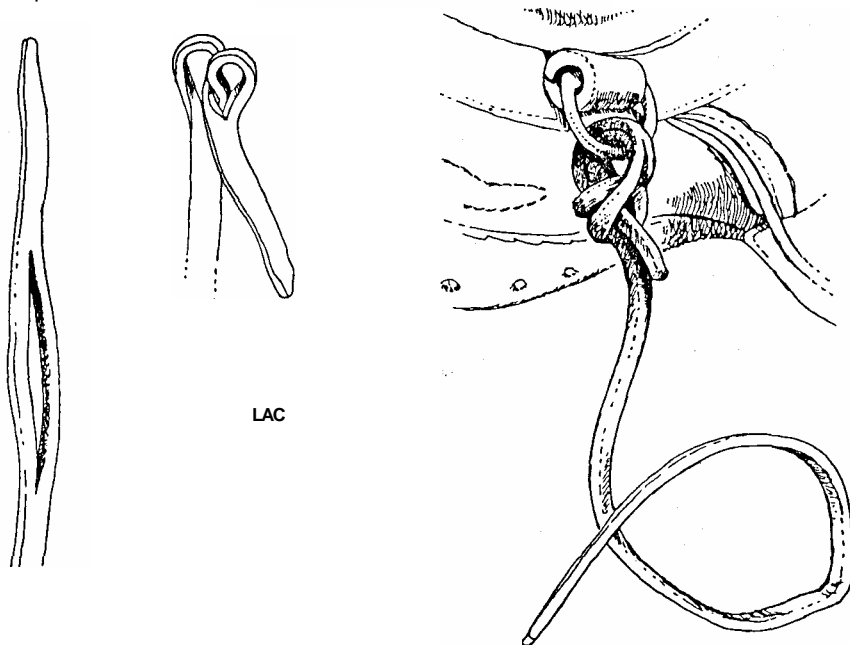

# SADDLE REPAIRS



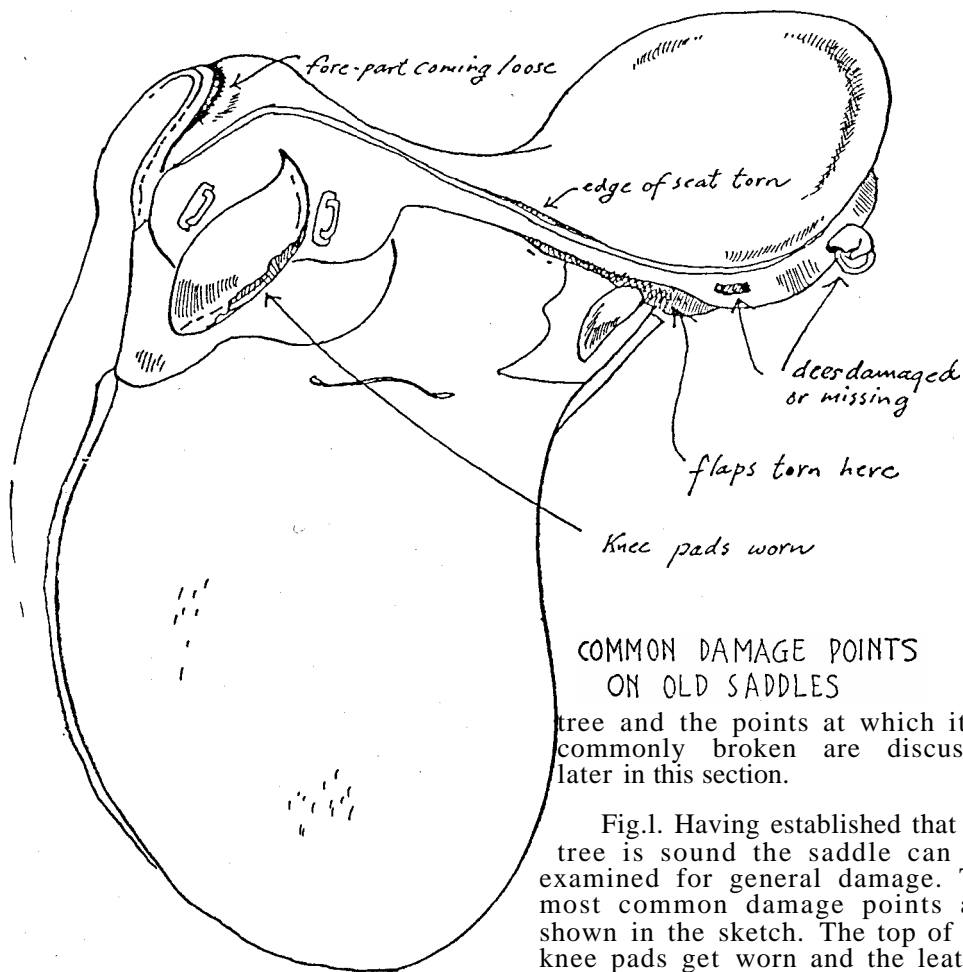

tree and the points at which it is commonly broken are discussed later in this section.

Fig.1. Having established that the tree is sound the saddle can be examined for general damage. The most common damage points are shown in the sketch. The top of the knee pads get worn and the leather cover torn. The dees at the back of the saddle to hold the saddle bags become damaged or fall off and the inner and outer saddle flaps get torn at the back. The fore-part begins to come loose and tears appear along the edge of the seat.

All these points can be repaired. Lifting the flap it may also be found that the girth straps are badly worn or damaged. The usual remedy is to cut them away entirely and use a Bates rig that goes over the top of the saddle. However it is not a hard job to replace the straps if they are required.

The contents of this part originally appeared as one of the sections in the first edition of my book on making a stock saddle.

Special thanks are due to saddler Lew Haines of Townsville who taught me many of the techniques described here.

#### SIMPLE SADDLE REPAIRS

The important thing to understand about saddles is that no one ever thinks of getting them repaired until they are almost past the point of being repairable. Because of this it may be of some interest to note the common faults found in old saddles and some of the remedies. The first thing to look for is a broken tree. A badly broken tree can make an otherwise good saddle useless. The

Assuming that a saddle is suffering from all these faults, and this is frequently the case, the first step is to separate the two main parts of the saddle. Please keep in mind that I am discussing the common stock saddle, other types of saddles will not necessarily follow this procedure.

Study the front of the saddle. If the seat and the panel have been pulled apart previously then the large stitches used to sew it together will be readily seen as shown in the sketch.

If not there will be a row of closer stitches down the front.

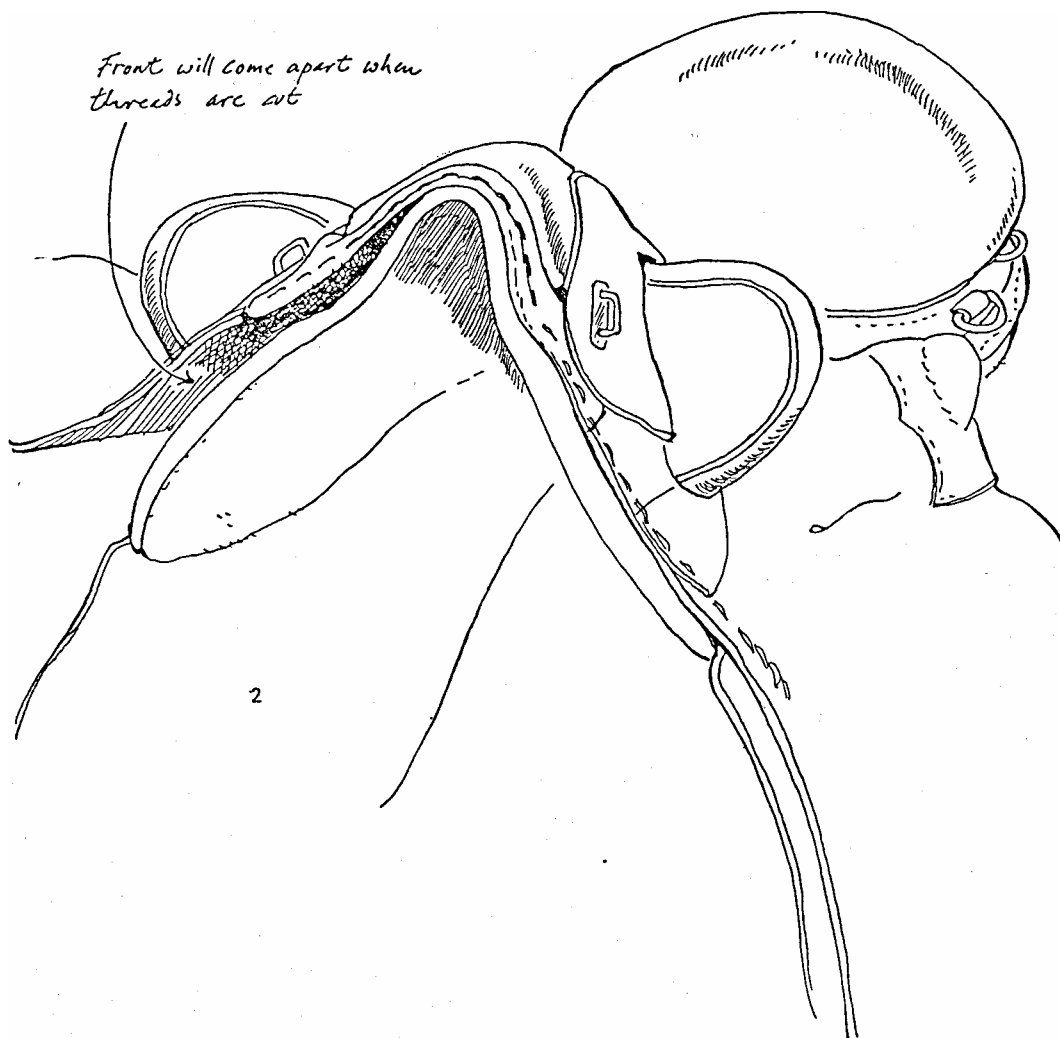
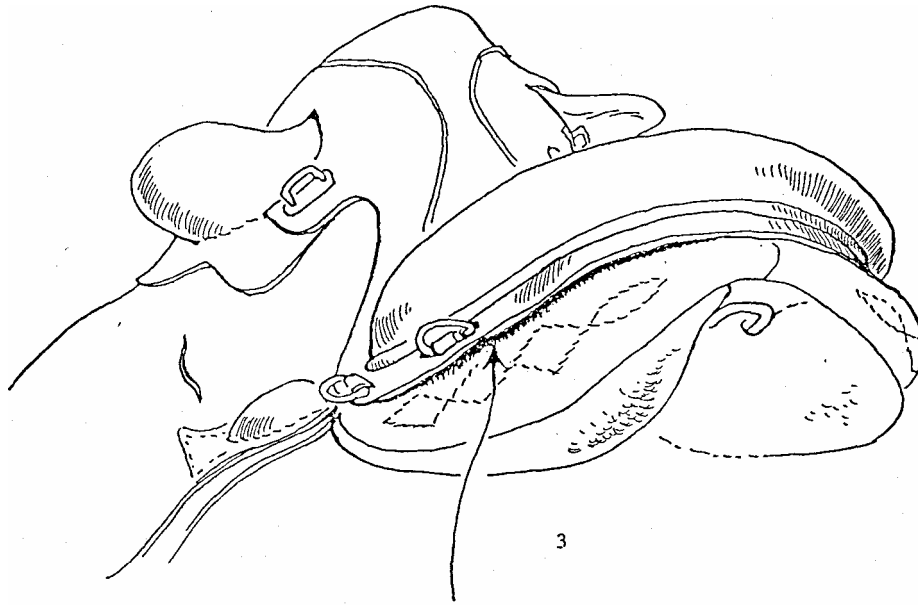

Fig.2. A sharp knife is inserted between the sweat flap and the outer flap and the stitches are cut. The front will then come apart.

Take care when cutting around the upper part of the saddle as there are often a few tacks put in here and it is far better to pull them out than ruin your knife trying to cut them.

Also take great care not to cut any of the leather of the saddle. By beginning at the bottom and pulling the top flap and the sweat flap apart and cutting only those stitches which are obviously holding the two flaps together this job should present no problems.



*cut stitches under here*

Fig.3. Now the saddle is turned around and the skirt lifted up at the back. Some very large stitches put in with a very heavy thread will be found here and these are also cut.

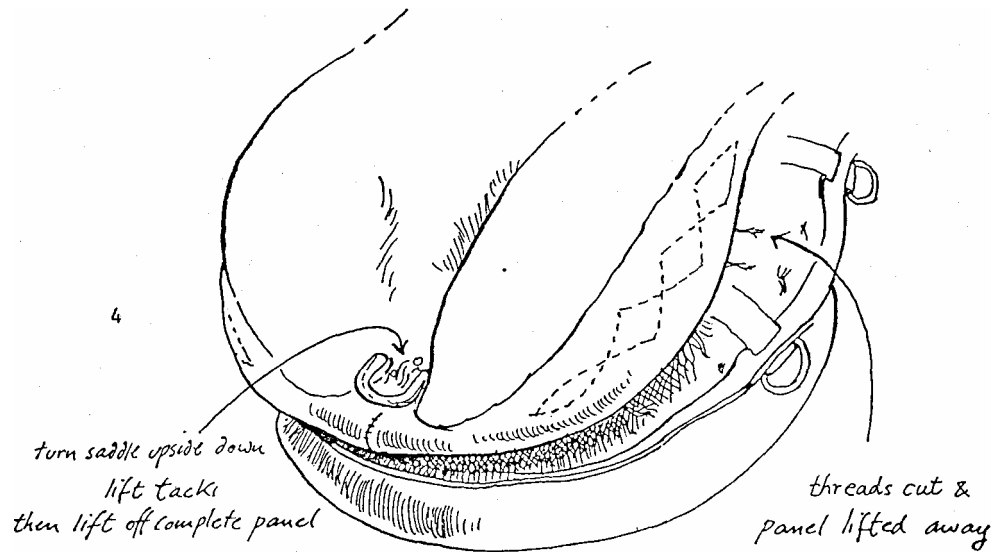

Fig.4. The area around the crupper bar will also have to be made free to move. This will mean lifting out some tacks.



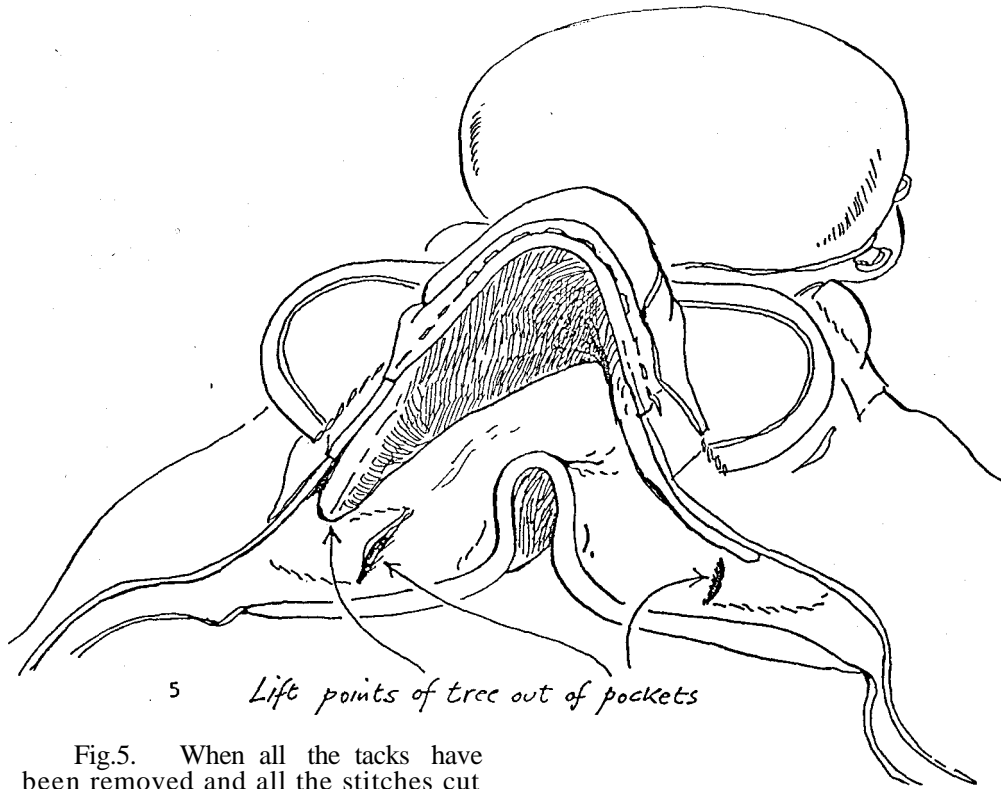
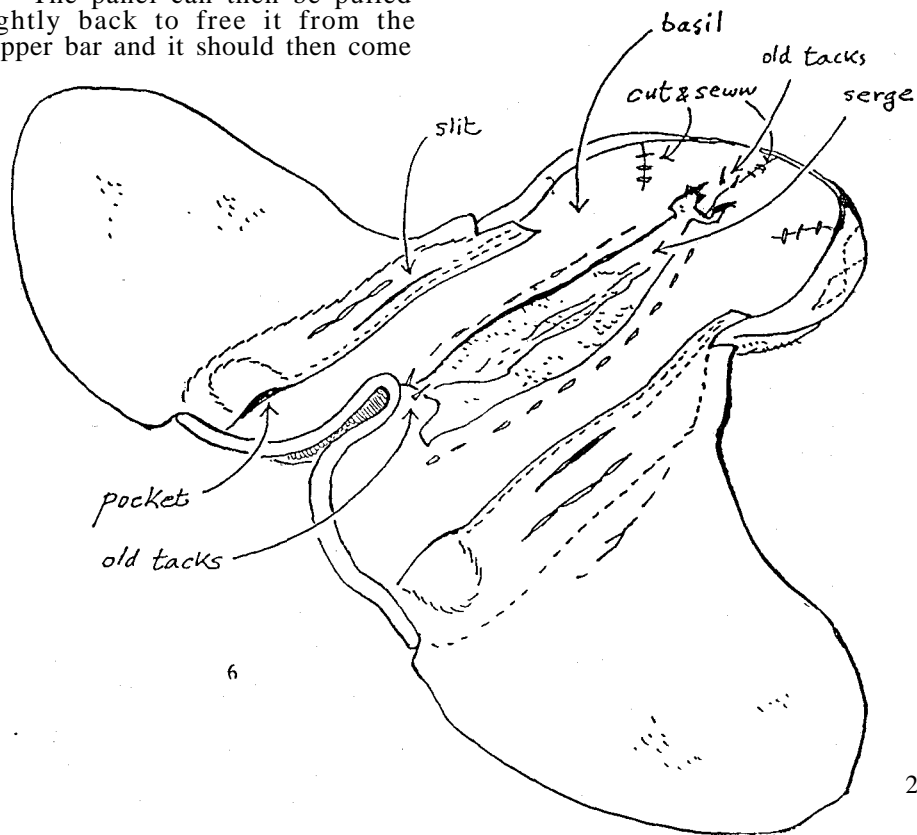

Fig.5. When all the tacks have been removed and all the stitches cut the seat can be lifted upwards at the front. This will lift the points of the tree out of the pockets in the panel.

The panel can then be pulled slightly back to free it from the crupper bar and it should then come



clear of the seat.

Fig.6. Once removed the panel is usually a sad looking object. When new it would have been well stuffed, plump and soft on the horse's back. By now the stuffing will have compressed into a thin lumpy layer if it has not actually begun to fall out. It will look something like the one in my sketch.

It is most important not to disturb the old filling in any way, and great care should be taken in handling the panel, especially when removing it from the seat. If the panel is badly torn and the stuffing looks to be in danger of falling out patch it up temporarily with masking tape or sticking plaster.

The reason for this is that the original stuffing will have packed down to exactly fit to the shape of the tree underneath. If you lose or displace this old stuffing then you cannot just patch over the remainder and then continue counter-lining.

If you lose the old lining then there is nothing on which to put the new counter-lining and so you must begin as if you were making a new panel, as outlined in "Making a Stock Saddle", using doehair instead of curled hair.

Looking at this sketch of the panel notice in front the old tacks that could have caused trouble when cutting through the front stitches, and also the few old tacks at the back near the hole through which the crupper bar was fitted.

This upper part of the panel is of basil (sheep skin). The lower part is of serge. Notice the slits through which the panel was originally stuffed.

Before we turn the panel over and put patches on the serge I will mention some common repairs that are often needed on this side of the panel.

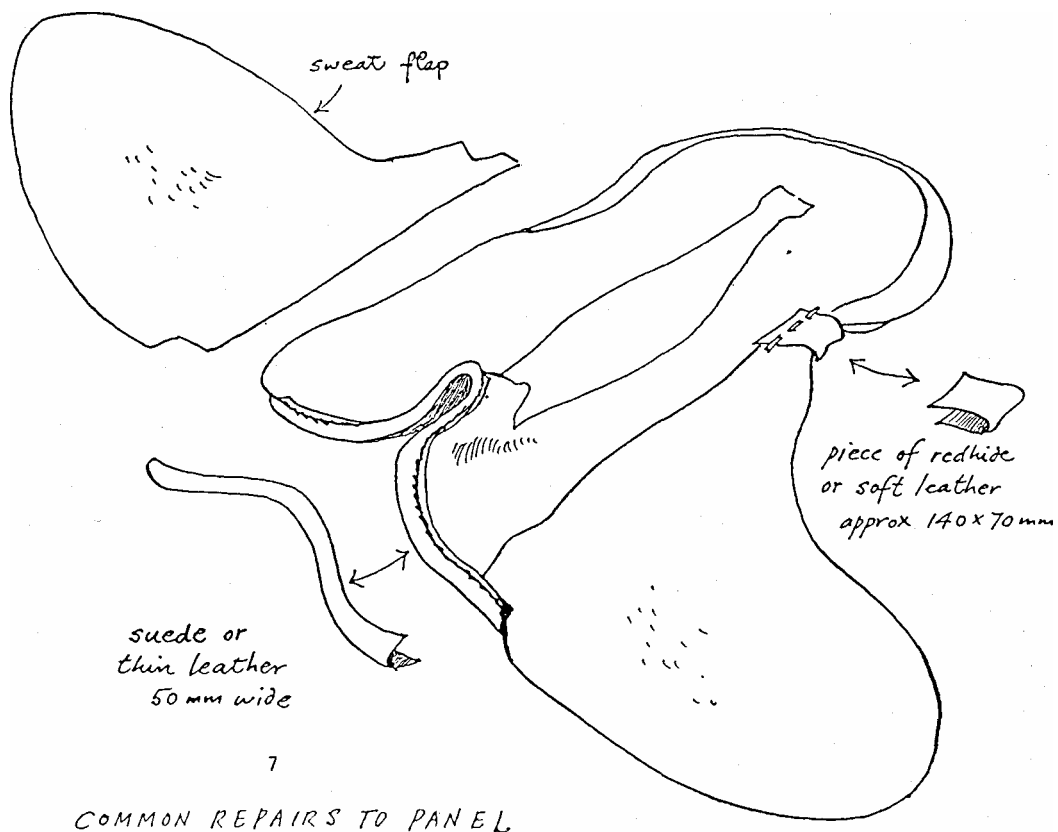

Fig.7. The back part of the sweat flaps have often torn loose from the panel and these are easily repaired using a piece of redhide or bag leather.

There is a roll of leather at the front of the panel called the front facing and if this is damaged it can be repaired by covering it with a strip of suede or any thin flexible leather sewn into place.

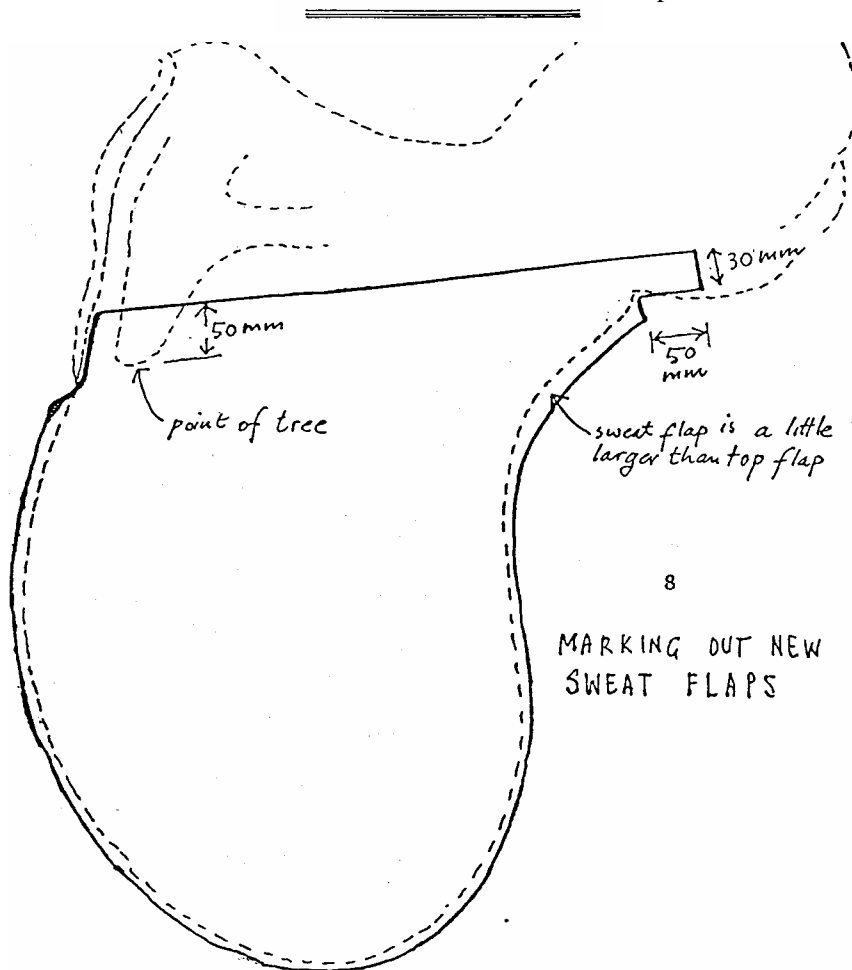

Fig.8. The entire sweat flap may need replacing and this entails removing what remains of the old one and preparing a new one using the old piece as a pattern.

If both sweat flaps are missing the outer flaps of the saddle can be used as a pattern. Remember that the sweat flap should be made 8mm larger all the way around so that the top flap is protected from the sweat of the horse.

When sewing on a new sweat flap always remember to leave a pocket for the point of the tree.

#### SEWING THE PANEL BACK

Having made all the necessary repairs to the seat and the panel they can now be sewn together again and the patching can begin. The amount of patching needed will depend on the condition of the saddle, but it is almost certain to need a new piece of material covering the channel (the central section of the panel) as this will be visible on the completed job and the appearance of the new counter-lining will be spoiled if the channel is left ratty and moth-eaten.

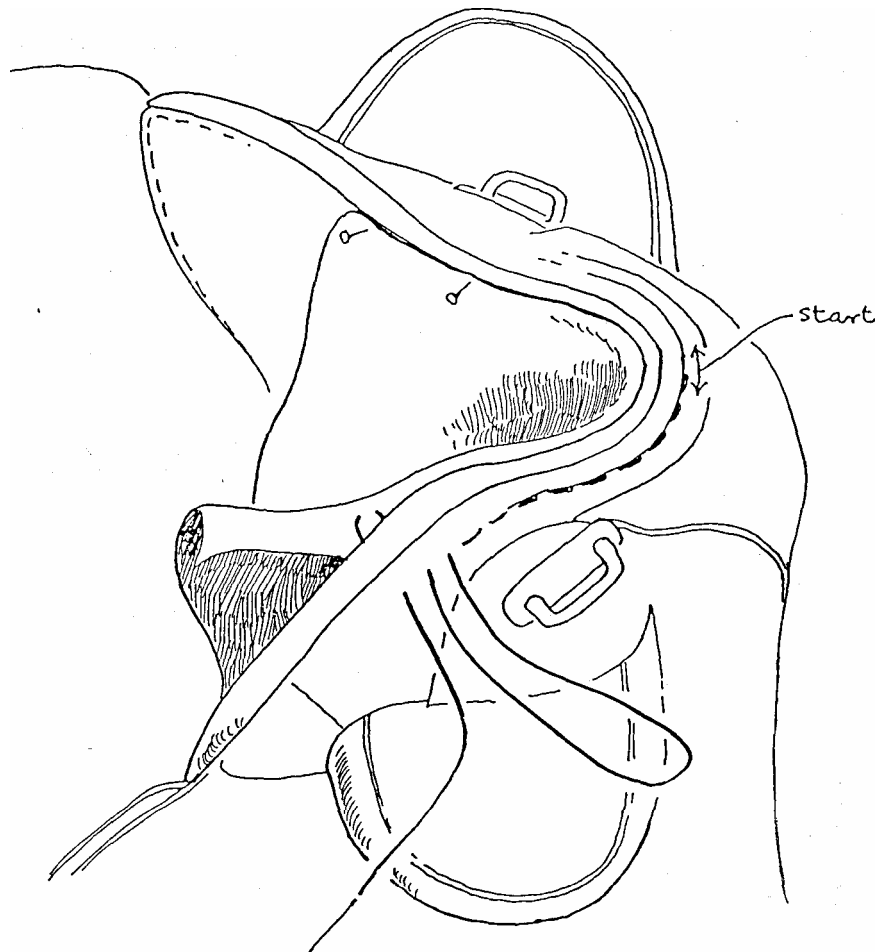

9 SEWING IN FRONT OF PANEL AND CHANNEL MATERIAL

Fig.9. The new material for the channel is attached at the same time that the panel is being sewn back to the seat.

(NOTE. If you need to put in new material for the channel then it is almost certain that you will also need to patch all the panel and then counterline it. This is covered in the chapter on 'Counterlining a Stock Saddle').

The channel material is 260 mm wide by the length of the saddle, plus a little extra to allow for the turn overs. It can be of either serge or kersey. Kersey is often chosen because it comes in bright check patterns, and also because it is cheaper, but many saddlers prefer to

use serge for the whole job. Serge is always used for the final covering of the panels on either side of the channel.

The panel is fitted to the seat taking care to see that the points of the tree go into the pockets and the crupper bar comes through the hole in the serge.

Now stitching commences using a 6 strand thread. Begin at the centre and use the same holes that the original thread occupied.

Notice that the needle does not go right through the channel material but only through the folded over part. In this way the stitches are not visible in the finished job.

Sew down the whole front of the panel before turning to the back.

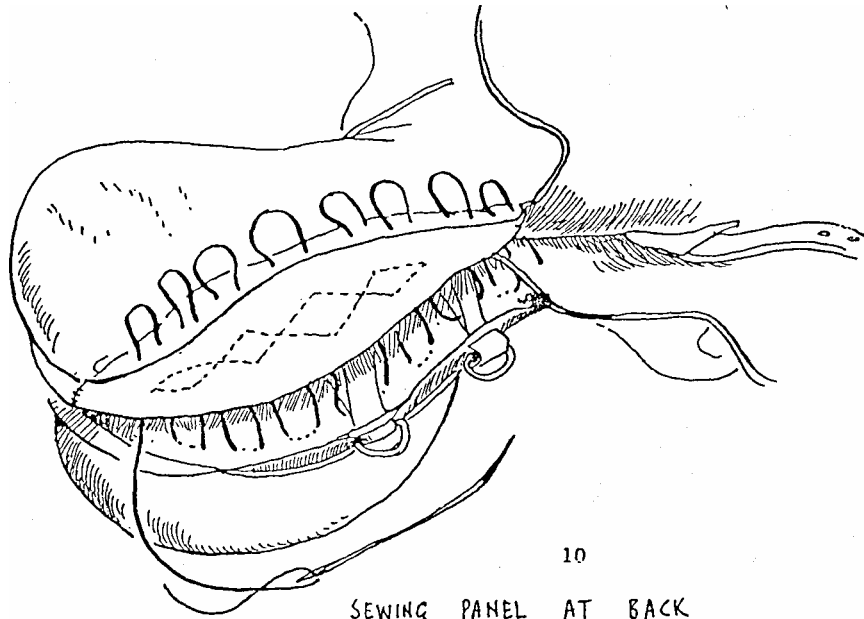

Fig.10. When it comes to sewing down the back of the panel an easier method can be used than the one followed when sewing a new panel.

Because the outer side of the panel is going to be covered with new serge

the stitches can come right through the panel as shown. This is much easier than sewing only through the basil.

The new counter-lining will cover the stitches.

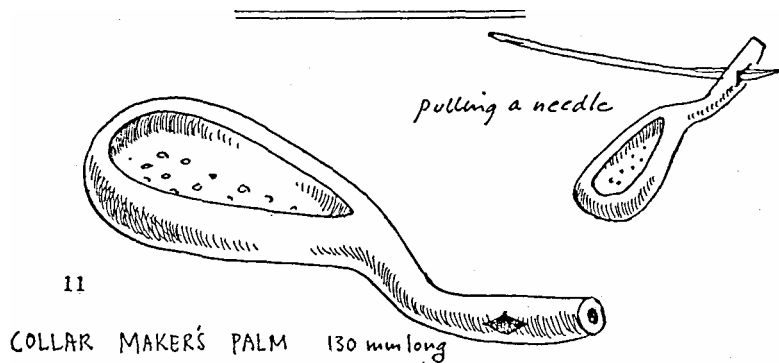

Fig. 11. However the panel is a bulky object and an ordinary needle will not go through it, so a long bag needle must be used. This can be pushed and pulled with an ordinary pair of pliers, but the best tool for the job is a collar maker's palm if one can be found.

Saddlers seldom stock them today but they may sometimes be picked up around old properties. They are shaped as shown and fit into the palm of the hand. When forcing the needle through it is pushed with the cupped part of the tool which has a dimpled finish to stop the needle slipping.

When the needle can be pushed no further the recessed end of the spout is used to give it a final shove.

To pull the needle through a heavy patch the diamond shaped hole is slipped over the sharp end of the needle and the tool is twisted so that it grips the needle.

When sewing the back of the panel to the seat use a heavy thread made from 10 strands of No.2, and leave the stitches loose as shown in Fig. 10. The stitches can be pulled tight when you have nearly run out of thread. This is easier than trying to tighten each stitch as you go along.

## Repairing the Tree

With the panel removed the tree can be examined. Its construction will tell you whether your saddle was originally a quality product or a shoddy one. It is this feature, hidden from the purchaser's eyes, that will reveal whether the original saddle

maker really cared for his product.

I have sketched two saddle trees to show the differences between a well made saddle and a cheap one. The good tree is from a Blair saddle, and it could be 50 years old. The sketch shows the underside of the tree.

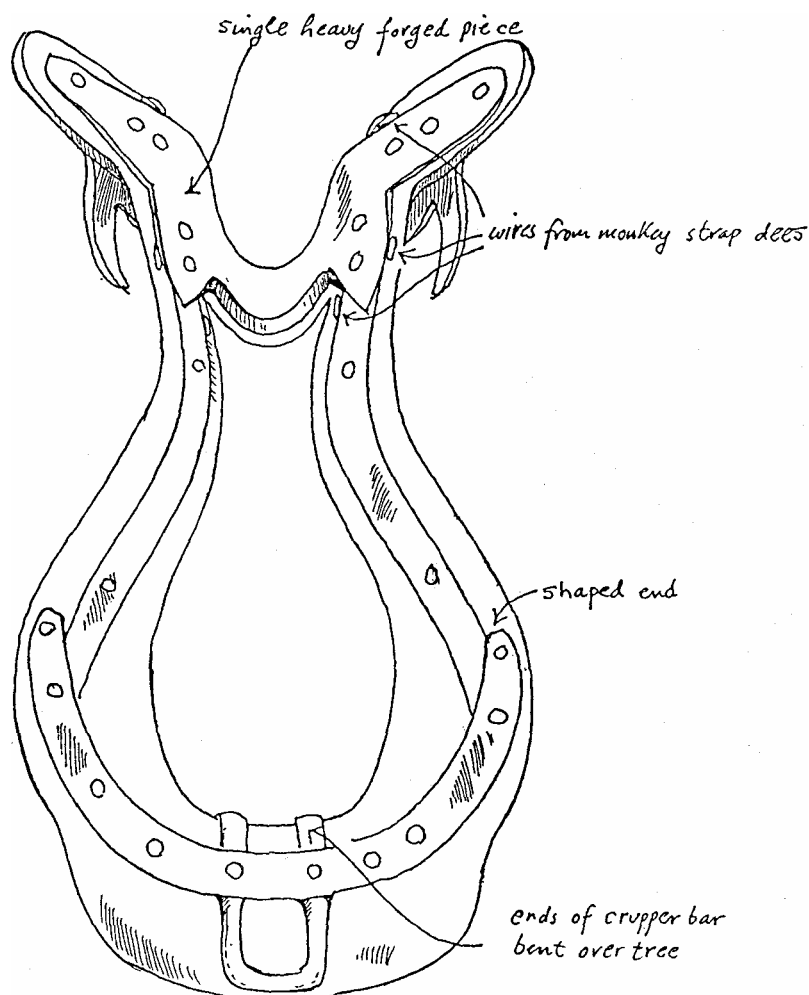

LOOKING AT UNDERSIDE OF TREE (BLAIR SADDLE)

Fig.2. The most striking feature is the heavy forged piece at the front of the saddle. Note how thick it is where it curves downward to fit the pommel. It would be almost impossible to break the tree at this point.

At the back of the saddle the crupper bar is also firmly anchored in place by bending its ends over the tree. The tree is made from wood strengthened with strips of metal, and notice that the ends have been shaped where two pieces join.

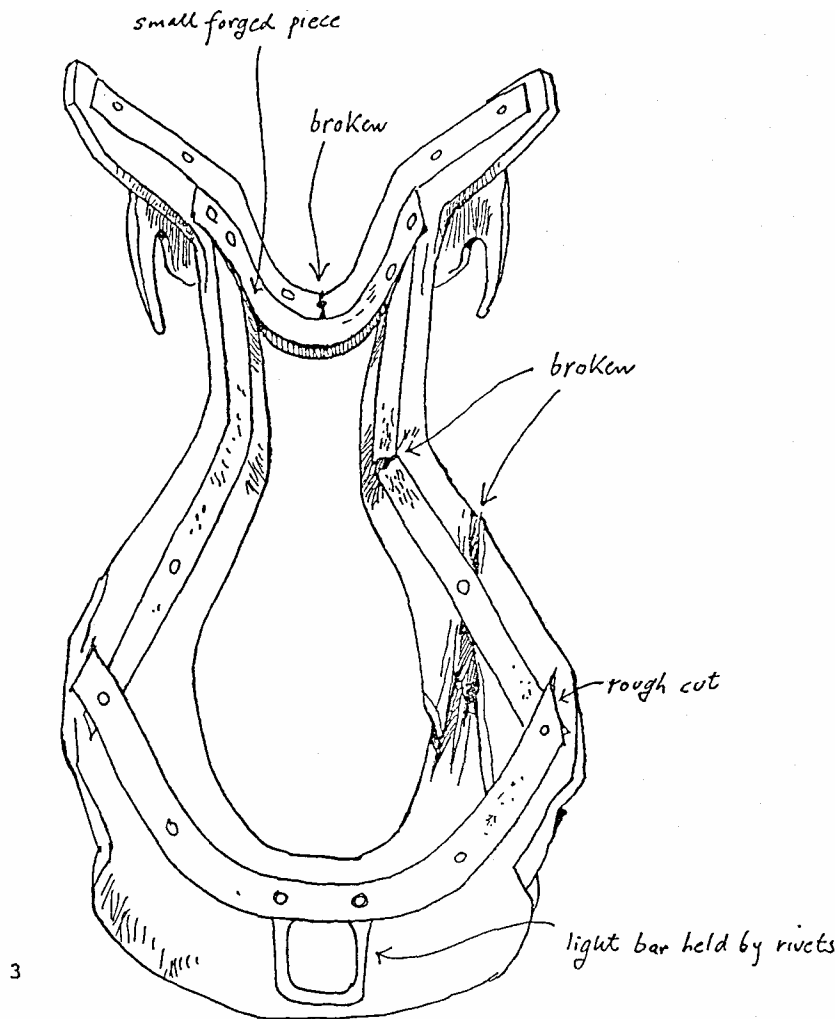

CHEAP TREE (underside) showing common breaking points

Fig.3. Now look at the sketch of a cheap tree. This saddle was not repairable and had to be thrown away. At the front there was only a small forged piece plus a light strip of metal strap, and this strap had broken in the middle at a rivet hole. Light strap had also been used for the rest of the tree, and this had broken as shown, and having broken the wood was no longer supported and this had also shattered.

The crupper bar is held only by light rivets and the wonder is that it has not pulled out long since. Notice also that the straps have been very roughly cut and also the wood of the tree has been shaped equally roughly.

It is important to understand what

the tree is and how and where it breaks because when buying a second hand saddle the tree is well hidden from view. By flexing and twisting the saddle the intending purchaser will be able to feel whether the tree is broken in any of the places indicated.

The problem of tree breakage has vexed saddlers for years and various attempts have been made to develop an unbreakable tree, but my saddler friends say that they have seen most of them broken.

In latter years fibreglass trees and other synthetics have appeared, all guaranteed unbreakable, but there can also be problems with these and the really unbreakable tree is yet to be found.

The reason that a broken tree renders a saddle useless is that the seat is built around that particular tree. To replace the tree would entail finding a tree of identical shape and this is very difficult. Also, by the time the seat with its stuffing and beneath that the webbing had all been removed from the broken tree it would probably be easier for a saddler to start again from scratch.

Of course it does sometimes happen that tree repairs are undertaken and the reason is usually one of plain necessity. On outback properties it is often the case of having to try and repair or ride without a saddle.

In true bush tradition most tree repairs consist of wrapping the broken pieces together with some sort of splint and a lot of wire. Although this will hold the tree together it does not prevent it flexing and will not be good for the horse.

I have seen a tree repaired with an advanced form of welding, one which requires special equipment out of the range of the average mechanic. In this type of welding the heat is so accurately localized that the timber beneath the metal strip does not burn.

The heat from ordinary welding will set the timber of the tree alight, but I have more or less successfully

repaired a tree by brazing another strip of metal onto the broken section to form a splint.

To do this I obtained some asbestos powder, a material not always readily available but used by welders when faced with this sort of problem. The powder is mixed with water to form a putty and this is placed around the job so that only the metal strip is left uncovered. The asbestos protects the timber of the tree from catching alight wherever it can be applied, but this does not prevent the timber directly beneath the strap from beginning to charr. The brazing has to be done with a small jet and as fast as possible.

Having completed the brazing I then patched the chipped, charred and splintered parts of the tree with the same poly filler used in repairing car bodies. This comes under a number of trade names but is basically a mixture of polyester resin and whiting. I also added a few layers of fibreglass material to give added strength.

Such a repair will make a saddle rideable again but it will not take any sort of ill usage as the tree can never be as strong as it was originally. At best it can only be regarded as emergency repairs until a new saddle can be bought.

### Replacing Dees

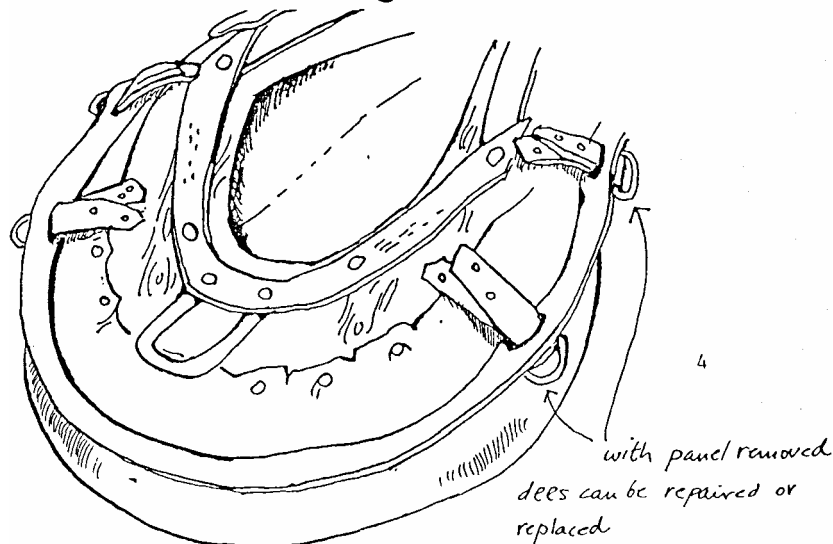

Fig. 4. The dees on the saddle that hold the saddle bags are usually the

first things to get worn and broken. However as they cannot be repaired



until the seat and the panel have been pulled apart it is not worth trying to repair them until other work is needed on the saddle.

Once the panel has been removed it is a simple job to replace the straps that hold the dees. It will be seen from my sketch that the dees are held by strips of leather nailed into the tree with

noticed that the two ends of the strap are not laid exactly one on top of the other but are slightly out of line. This is so that they do not make a lump where they press into the panel.

As it is such a simple job to replace the dee straps at this stage it is advisable to do the lot if they look at all worn.

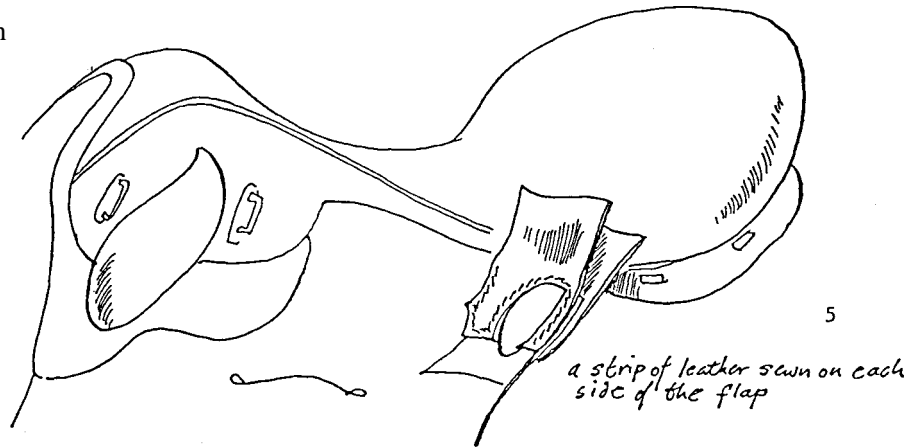

20mm cut tacks. It will be

### Repairing a Torn Flap

Fig.5. As noted earlier the flaps usually get worn and torn at the back of the saddle. To repair them two strips of leather are taken, each about 140 x 80mm though the extent of the damage and the type of saddle will have a bearing on the exact

One piece of leather is shaped to fit around the thigh pads, if the saddle has any, and the other piece goes under the flap. The two pieces of leather are then sewn together with the flap in between as shown in the

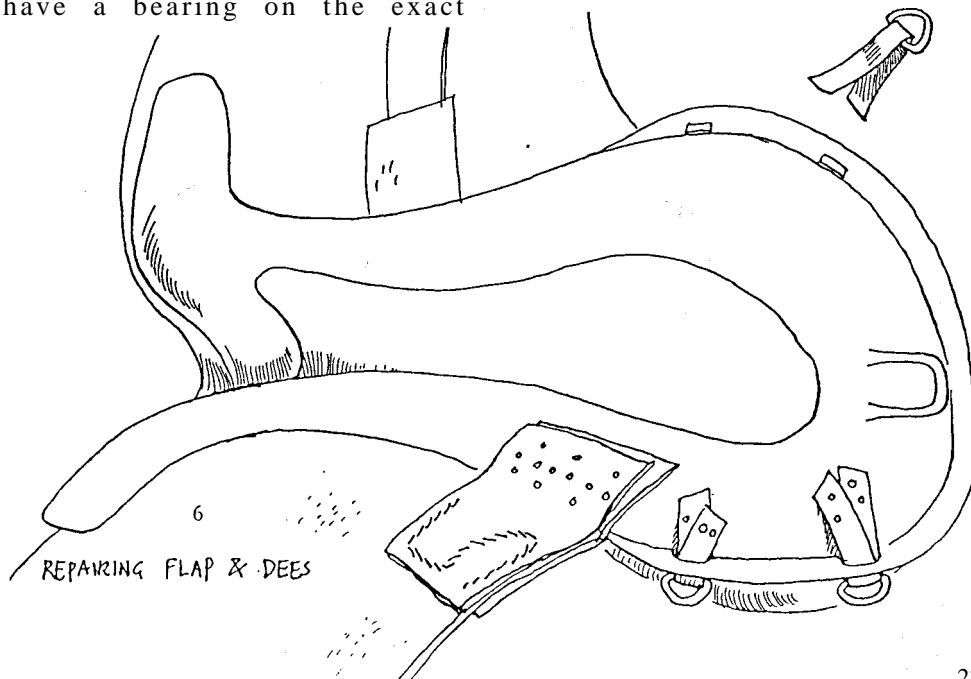

dimensions.

sketch.

Fig.6. Turning the saddle onto its back the two strips of leather are then tacked onto the tree with 20mm cut tacks as shown. Take care before tacking to see that the flap is going to hang correctly.

## Replacing Girth Straps

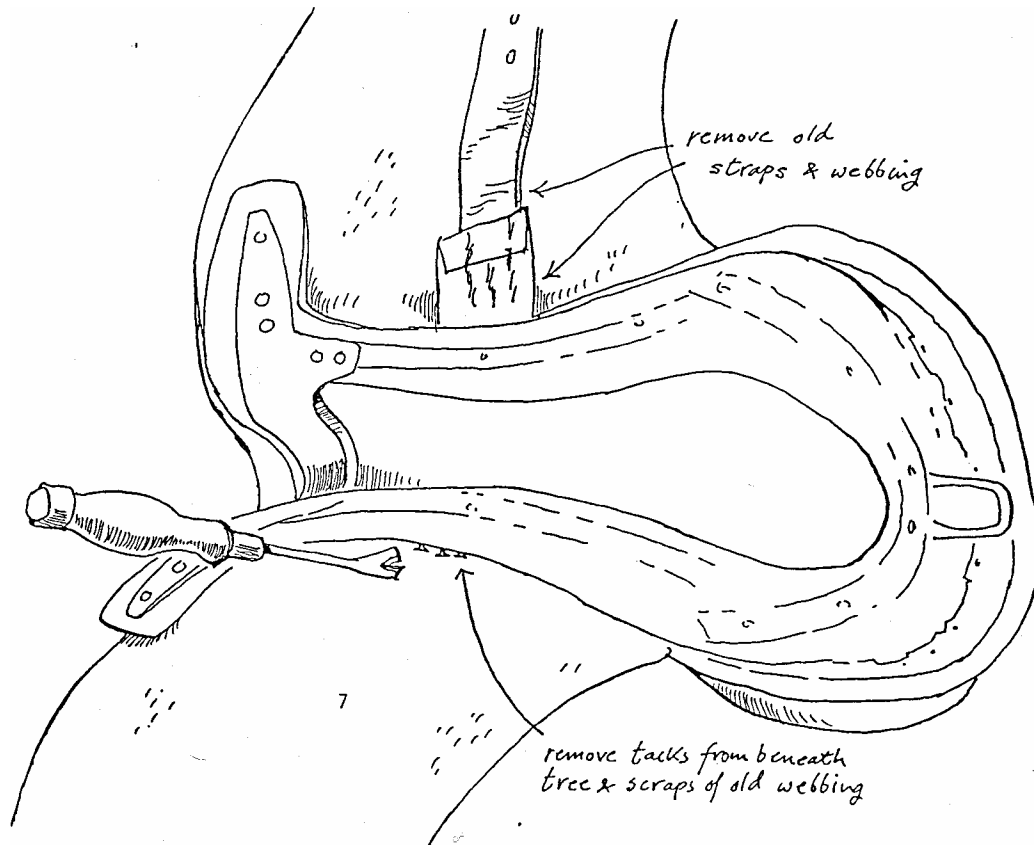

Worn and torn girth straps can be replaced, but the more usual practise is to discard them entirely and change to using a Bates fastener that goes over the saddle and does not need the girth straps.

However, as the replacement of the straps is a simple job it may be desired to undertake it while the saddle is apart.

Fig.7. The first step is to remove the old straps and also the strip of webbing to which they were originally attached. This strip of webbing goes right across the tree from one side to

another. It may be possible to fit a new piece of webbing in the same place, and hold it with a few tacks into the edge of the tree.

However, it is not always possible to do this and so the repairs are done in a different way.

Having cut away the old webbing some time must now be taken using a tack puller or a screwdriver, poking around under the tree to remove the old tacks that held the webbing in place. When this has been done the tree at this point should be free of tacks and clear to take the new strip of webbing.

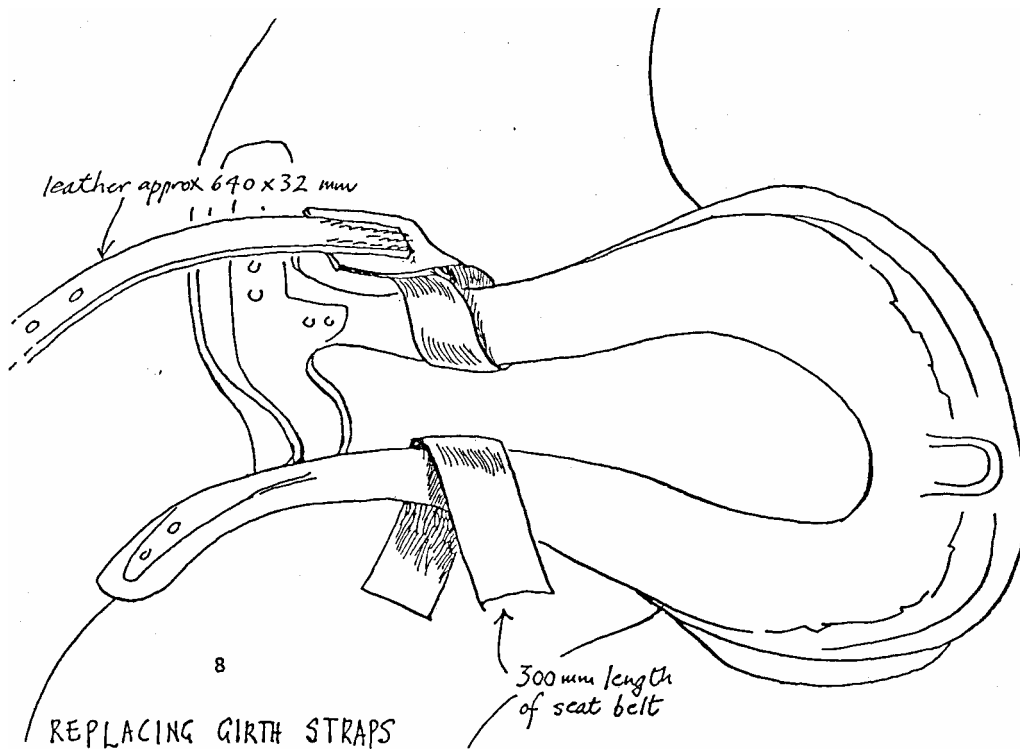

Fig.8. Instead of using saddler's webbing the modern practise is to use old pieces of seat belt as these are far stronger than the original material. A section of around 300 mm long is slipped under the tree as

shown and the new leathers sewn onto it with stout thread.

For convenience I have given a length for the leathers but the usual practise is to make them 100 mm longer than the flaps.



## SEAT BREAKING LOOSE

The saddle gets a lot of wear under the rider's legs and on very old saddles the seat will sometimes come loose along the welt at this point. It is little use trying to sew the two edges together again for the leather will invariably be very thin by this stage.

The only permanent answer short of putting a new seat on is a patch.

A scrap of thin strong flexible leather is used such as Kangaroo skin. This is cut to follow the curve of the seat and then sewn on as shown in the lower left hand sketch.

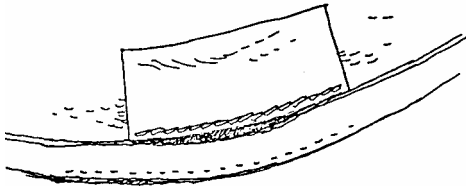

It is then turned over and sewn down in whatever way seems convenient. It will look best if the patch finishes flush with the edge of the skirt as shown at right, above. The stitches however should not go only through the skirt but should go right through the flap as well, otherwise the patch will simply lift up the edge of the skirt without holding the split together.

If you do not wish to remove the panel from the seat then it may not be possible to sew the patch down as shown. In this case the patch will need to be brought further down the flap in order to get the needles through, as shown below.

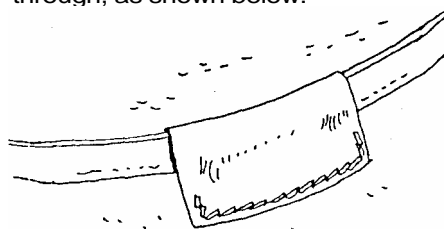

# PUTTING ON A NEW SEAT

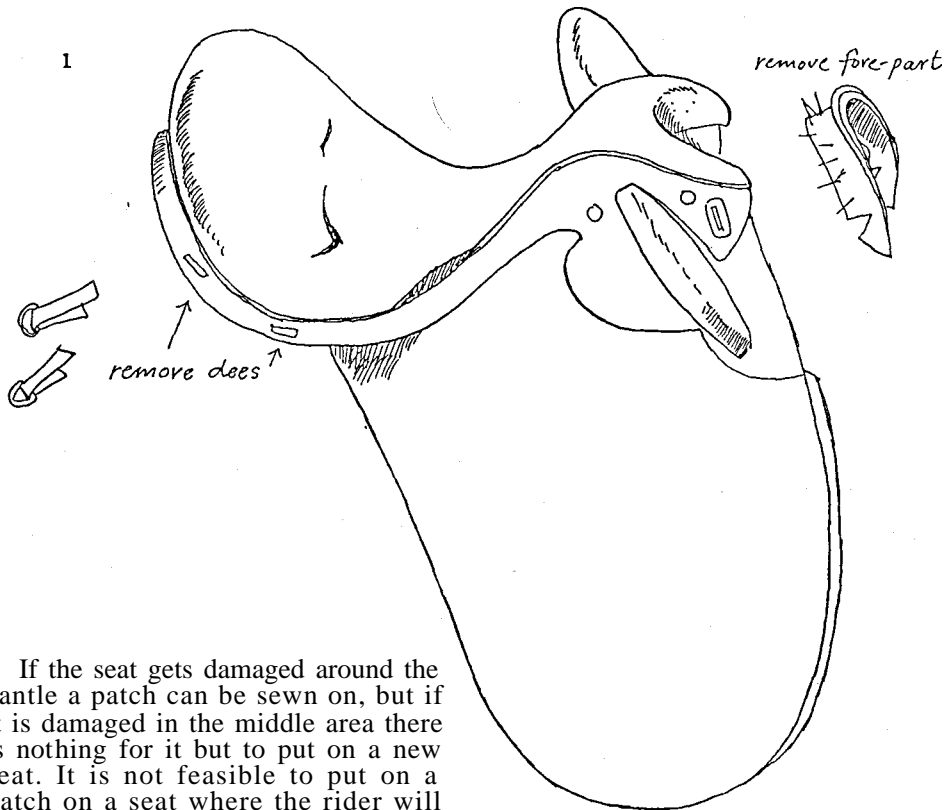

If the seat gets damaged around the cantle a patch can be sewn on, but if it is damaged in the middle area there is nothing for it but to put on a new seat. It is not feasible to put on a patch on a seat where the rider will sit, for his movement will soon roll the edges of the patch and it will generally be found to be uncomfortable.

In any case when dealing with an old saddle a split in the seat is usually a sign that the whole seat is on the way out, so there is no point in trying to patch it, for as soon as one part is fixed another will split.

A saddler will usually recommend buying a new saddle rather than mending one that has become so old, but people become attached to their old saddle, so if you want to put on a new seat here is how to go about it.

Fig.1. First remove the panel from the seat, as explained at the start of this section. Carefully remove the fore-part, as this will have to be replaced later. Remove the dees, they are probably in need of replacing and this can be done as part of the job.

Any good quality soft, flexible yet strong, leather can be used for the job. Saddler's bag leather is good or plain 3 mm leather of the type used for carving. It may be better to take it from the belly area of the side where the leather is the most flexible.

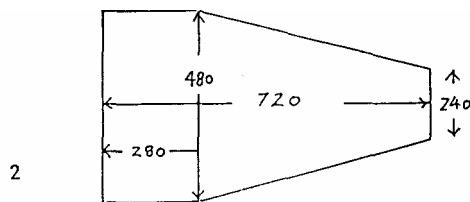

Fig.2. Measure the maximum width, including the skirt, and also the length and cut out the leather. The dimensions given here were the ones used for this particular job and are only included as a rough guide. Give the leather a good soaking.

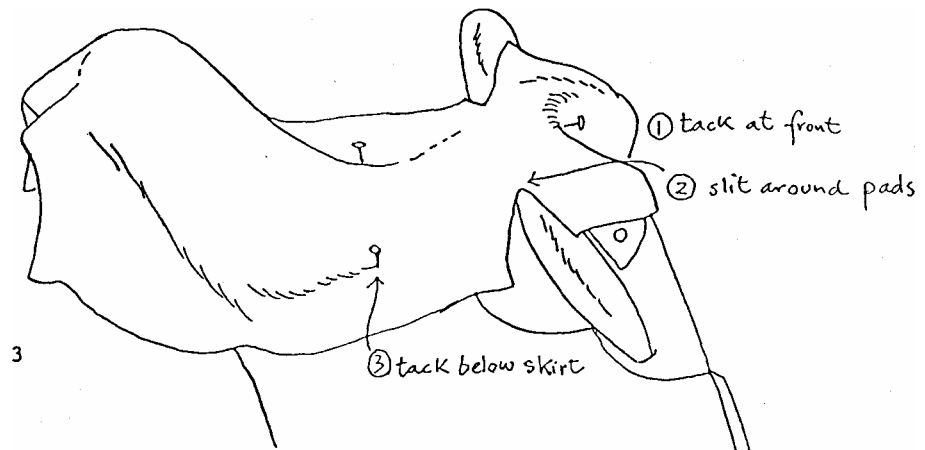

Fig.3. When the leather has been well soaked place it on the saddle and tack it at the front. Carefully cut a slit so that it will sit around the knee pads. Press down firmly and smooth it towards the waist and then place a couple of tacks just below the skirt to hold it.

Fig.4. Take your piece of bone, or rectangle of plastic and begin smoothing down the leather working from the front and tacking as you go. It may be necessary to make a few nicks in the leather so that it will lay down flat. Place all the tacks below the skirt. The bone is constantly used to smooth down the seat as shown.

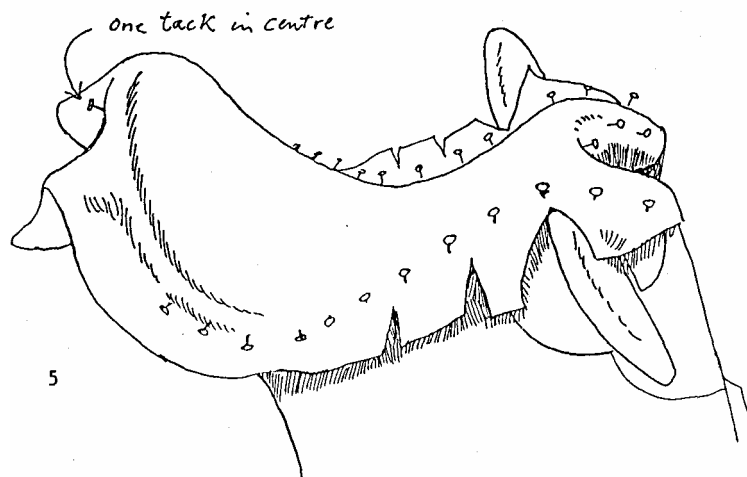
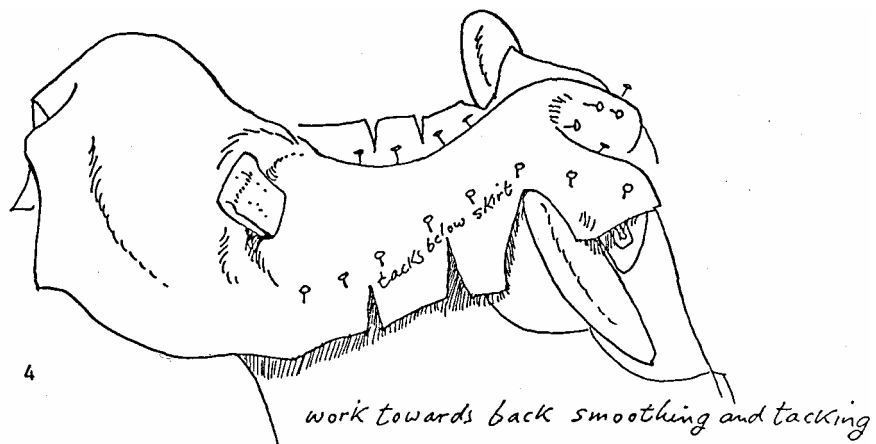

Fig.5. After some work with the bone the top part of the seat will be worked out smooth. Now put a tack at the back in the centre where the skirt joins the seat.

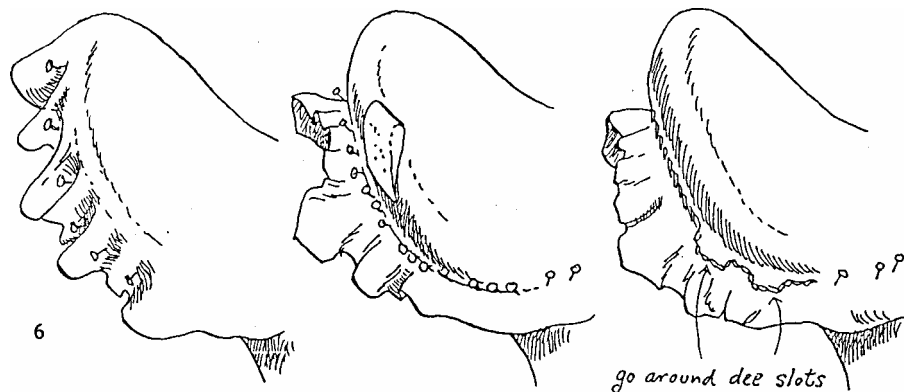

Fig.6. This part of the job is similar to fitting a seat to a new saddle. You divide the wrinkled section into two parts and put a tack in the centre, then you divide these parts into two smaller wrinkles and put in more tacks and so on.

While doing this you constantly work over the wrinkles with your bone. With patience all the wrinkles will be worked out and you will have a line of tacks where the skirt joins the seat as shown in the centre sketch.

Sewing from just outside one flap to the other you go around the back stitching as close to the inside of the skirt as possible. The stitching goes on the outside of the slots for the dees.

Fig.7. Turn the saddle over and see how far along you will be able to continue sewing. In this case the saddle that I was using for the sketches was one of the old Syd Hill ones with the so-called unbreakable tree. This had the unusual shape shown at the right, a wide steel plate over the wood of the tree.

In this case I could only sew to the point shown, so an awl hole was pricked through.

Common sense is required for this part of the job, different saddles can be sewn in different ways. In this case I would have to sew right through the flap in order to hold the seat at this point. In the case of a saddle with a wide skirt it may be possible to just continue sewing to the skirt as has been done around the back section.

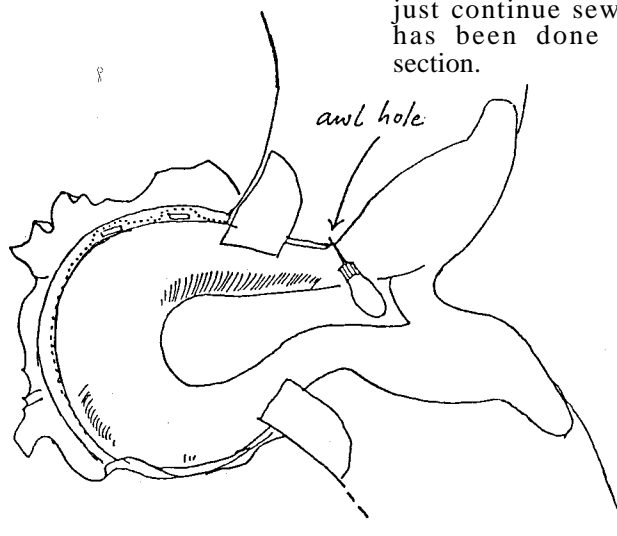

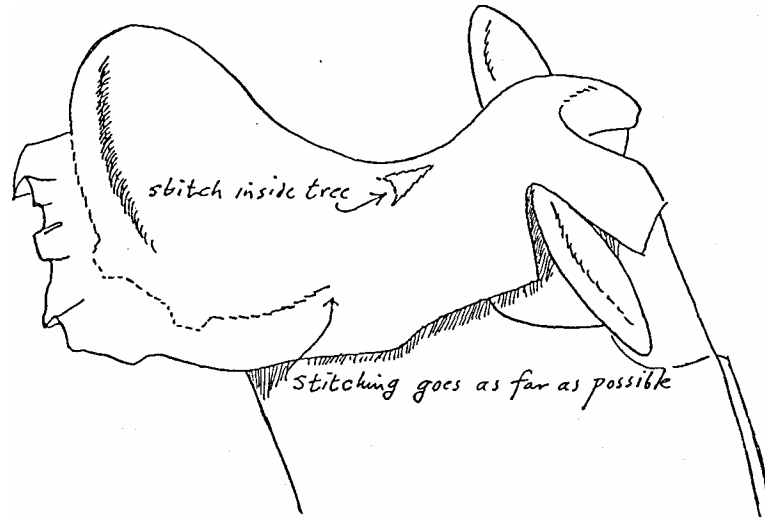

Fig.8. Stitching now goes as far as possible, in this case as far as the awl hole. A part is then sewn inside the tree to hold the leather in place at this point. This can be sewn in a decorative pattern if desired, and to any desired dimensions.

to whatever looks best. Cut out the slots for the dees and replace them. Replace the fore-part and the new seat is complete.

Now it only requires the panel to be sewn back as described elsewhere.

Fig.9. The leather is now trimmed off close to the skirt at the back. At the front it can be trimmed as desired

(As a matter of interest this saddle had very high knee pads of 5.5" (140 mm). Such pads are not made today.)

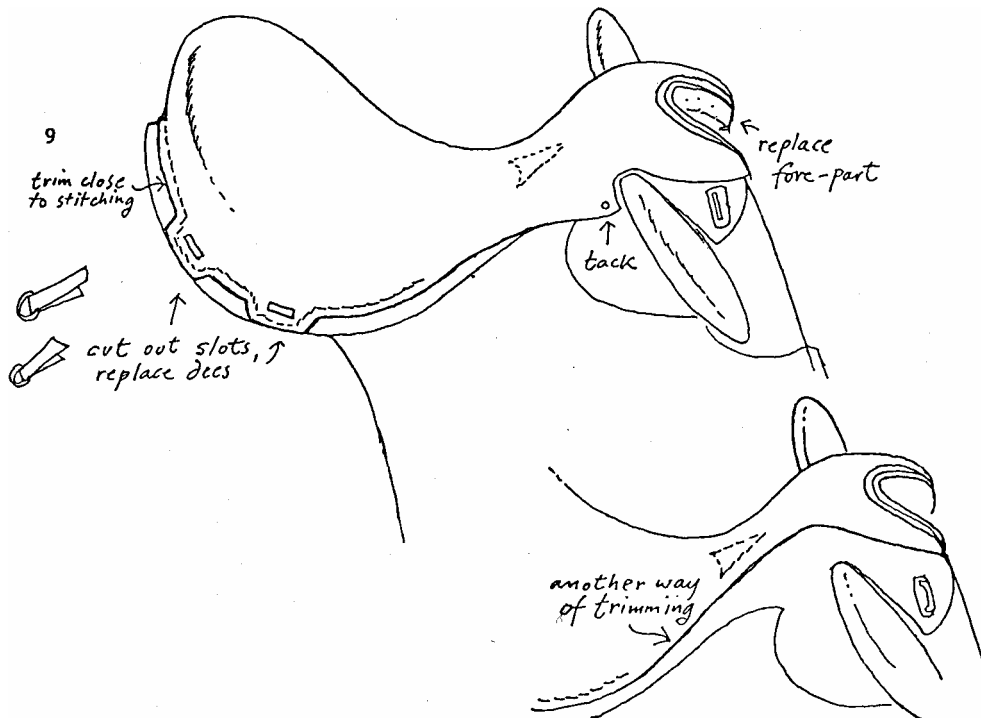



# Counterlining Stock Saddles



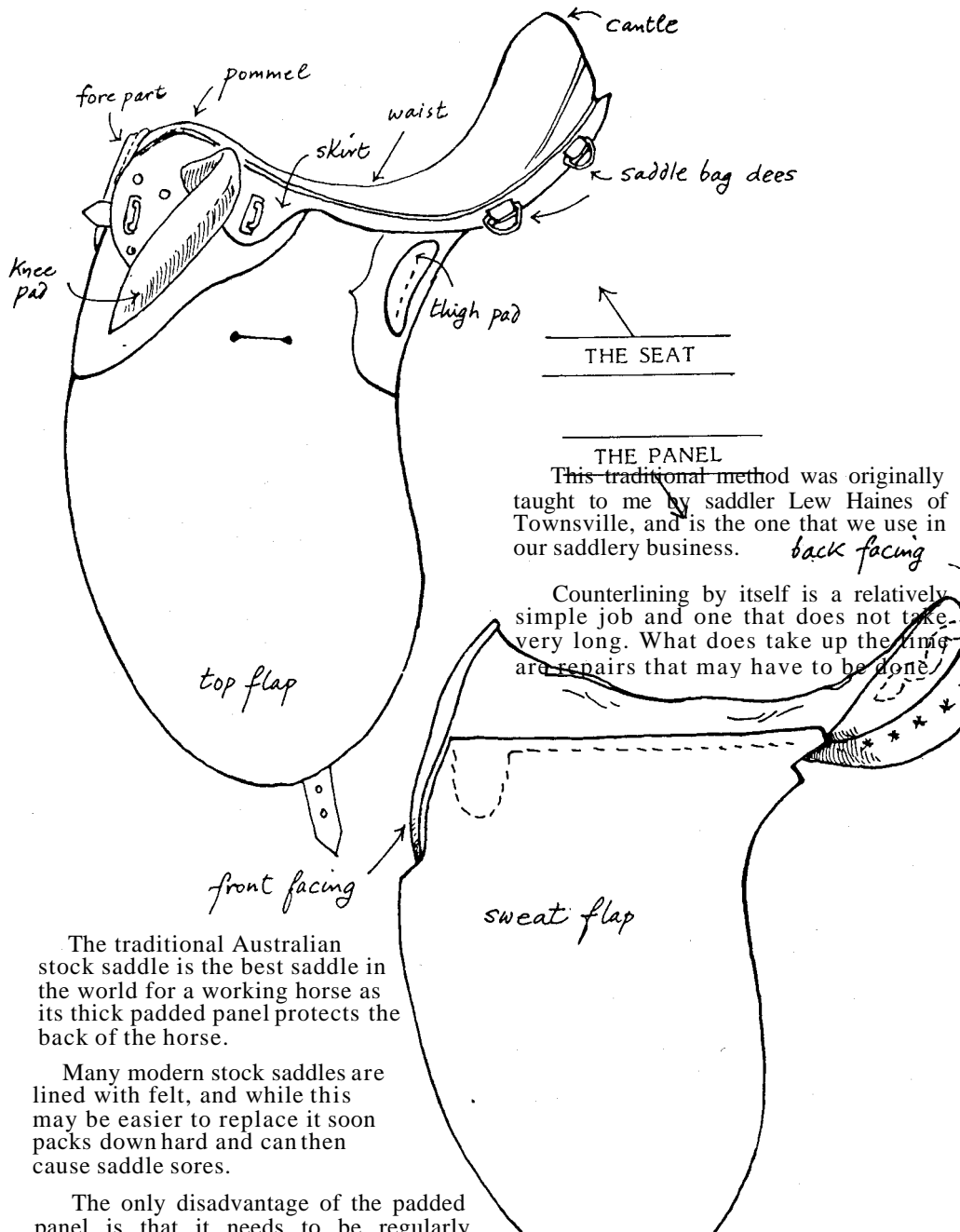

The traditional Australian stock saddle is the best saddle in the world for a working horse as its thick padded panel protects the back of the horse.

Many modern stock saddles are lined with felt, and while this may be easier to replace it soon packs down hard and can then cause saddle sores.

The only disadvantage of the padded panel is that it needs to be regularly counterlined.

This information on counter-lining was originally included in my book on saddle making. However a lot of outback people said that they would never get around to making a saddle, but they did want to learn about counter-lining so how about printing the counter-lining section as a separate section.

before the counter-lining can begin.

If there is no need to patch the panel or remove it from the seat then counter-lining can begin immediately. However it often happens that the saddle needs some repairs such as patching the panel and replacing the channel before counter-lining can begin.

When a saddle is new the panels are padded with doehair. After a time this packs down into a hard felt like state and will begin to rub sore spots on the horse's back unless something is done about it.

The remedy is to counterline the saddle. This means that a new lining of material is sewn over the existing one and the space between the new and old material is stuffed with curled hair.

As time goes on this in turn will pack down, and whenever it does so it is removed and new counter-lining put in place.

It is not possible to say how often a saddle needs to be counterlined. One that is used for stock work every day may need to be counterlined in six months, but a saddle that is used only for pleasure riding may last many years before it needs attention.

On the other hand trail rider Brian Taylor told me that he once worked on a station where it was the custom to have the saddles counterlined when they were only a few weeks old, as soon as the filling had packed down a little.

The idea behind this was that the original lining material was kept in the best possible order and so new counterlinings could be replaced and sewn onto this original material over and over again.

Unfortunately this sort of foresight is extremely rare and most saddles are left far too long before they are counterlined. This results in worn and damaged panels, often with the material covering them rotten with horse sweat. This in turn means that the panel must be patched before the counter-lining can take place.

## MATERIALS NEEDED

**SEWING AWL.** This awl has sharp end and is used to make holes through leather when sewing. See page 258 for a illustration.

**THREAD.** Any strong thread is suitable for counter-lining and it need not be waxed. Linen thread is good and synthetics such as nylon can also be used. Cotton is not suitable as it may rot.

**SERGE.** Woollen serge is usually plain khaki or dark blue. A piece 700 X 700 mm will be needed to counterline the average saddle.

If the saddle also needs patching another piece of the same size or a bit larger will also be needed.

**KERSEY.** This material is mainly used for saddle cloths. It usually comes in check patterns and is cheaper than serge. For this reason saddlers often use it for patching the saddle panel instead of serge. However the difference in price is not great enough to warrant its use if only a couple of saddles are being counterlined.

**COUNTER-LINING NEEDLE,** A small curved needle.

**HARNESS NEEDLES.** These are like ordinary needles but have a blunt point. They are used in pairs.

**MATTRESS NEEDLE.** A very long needle used for quilting the counter-lining. Two types are shown on page 255.

**SEAT AWL.** This awl has a smooth polished shank, just the opposite of the sewing awl. Illustrated on page 258.

**BELLY STUFFING IRON.** This can be home made, see page 254.

Some tacks are also needed to temporarily hold the serge in place and also a little over a metre of coloured woollen yarn to make the pom-poms, see page 256.

## BEGINNING THE PATCHING

If the old serge on the saddle is at all weak or rotten it is pointless to sew new material to it as it will only tear away after a short time. It is far better to spend a little more time and properly patch the panel before beginning the counter-lining.

It is most important not to disturb

the old stuffing as this will have settled down firmly into the shape of the saddle tree and so will provide the correct foundation for the counter-lining.

For this reason it is best not to rip off all the old serge when beginning to patch but rather to only remove a piece at a time as necessary.

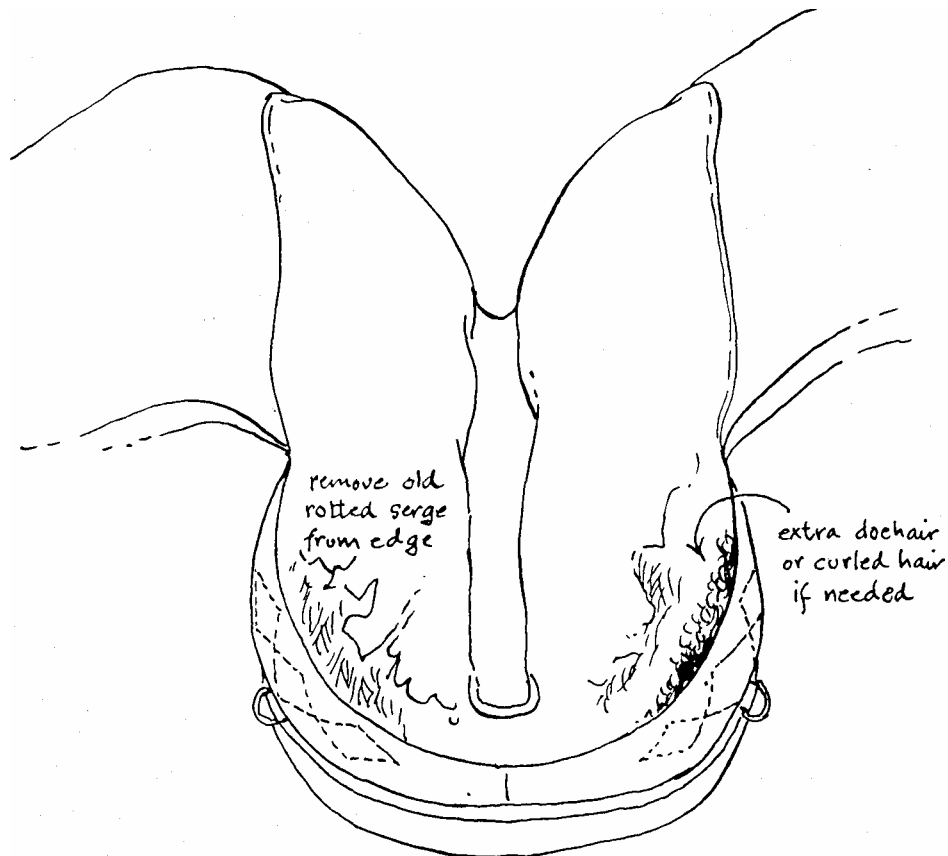

## PREPARING TO PATCH PANEL

Fig.1. First the old serge is removed from where it has been sewn to the back facing (and again I must stress that this is only to be done if the old material is rotten. If it is sound then it should be left as it is).

When the old material and scraps of thread have been cleared away the back of the saddle can be examined to check that both sides are of the same size and

shape. This is most important especially if the saddle has had more than one owner, for poorly done repairs in the past can often result in a lopsided back, and in addition the original stuffing may have settled down unevenly.

In order to get both sides even extra doehair (or curled hair if no doehair is available) may be firmly packed and lightly hammered between the old filling and the back facing as shown.

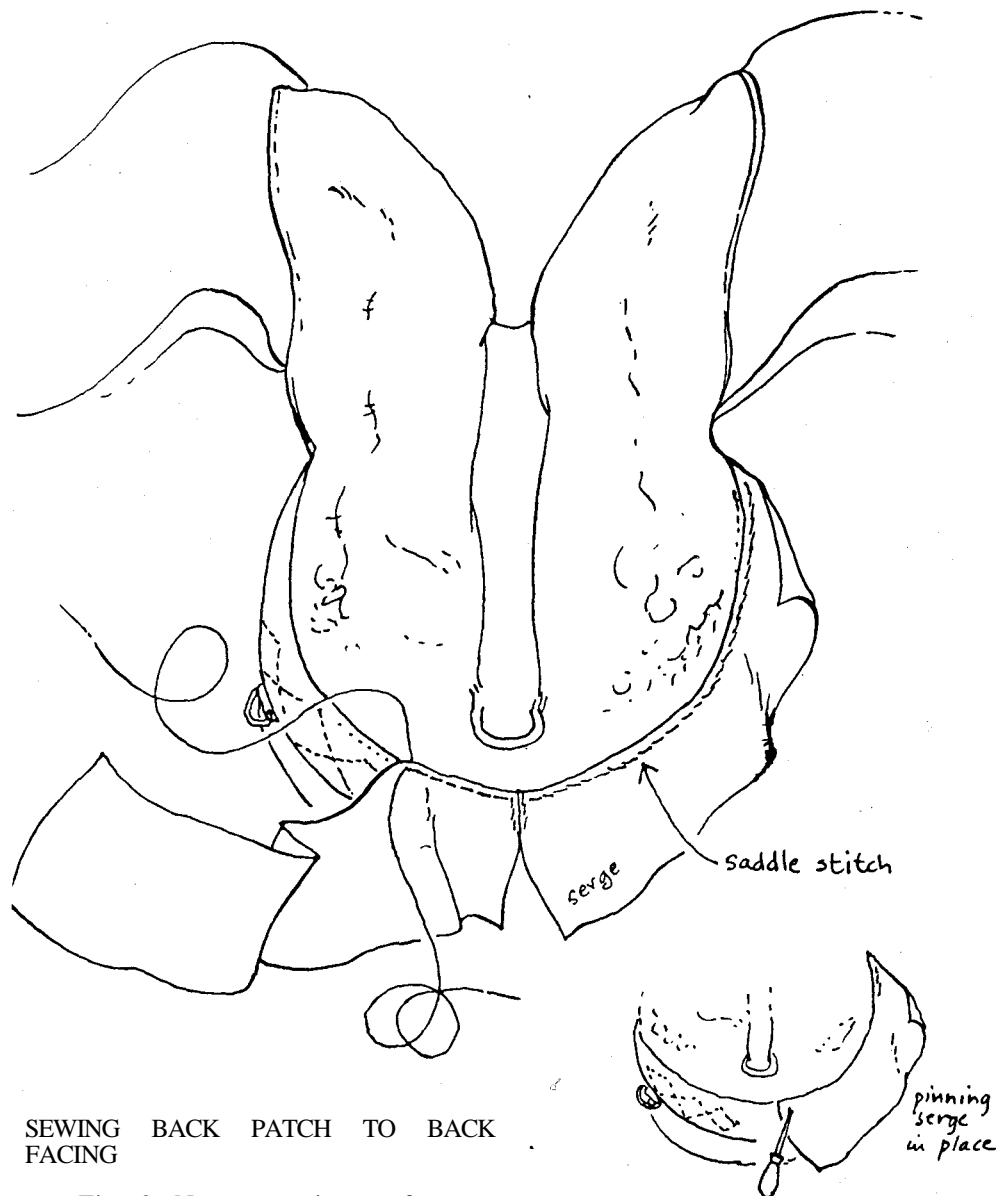

SEWING BACK PATCH TO BACK FACING

Fig. 2. Now two pieces of scrap serge are sewn to the back facing using two needles and the usual saddler's stitch. In order to keep the material in place while sewing is taking place it can be pinned with a tack or a seat awl as shown in the smaller sketch.

The reason that two pieces of serge are used for the back patch rather than one single length is purely one of economics. Serge is expensive and this is one good way of using scraps.

In any case the serge is going to have to be cut in the centre to fit around the

crupper bar and so two pieces may just as well be used and joined by a few stitches as shown.

Kersey, the material used in saddle blankets, is cheaper than serge. It can be used for the side patches and the channel but not for this back patch because a thin strip of this patch will remain visible in the finished job. This will not be noticed if serge is used but would be very visible if it was bright coloured material.

PATCH  
ON  
PANEL  
EDGE

Fig  
3. The  
next

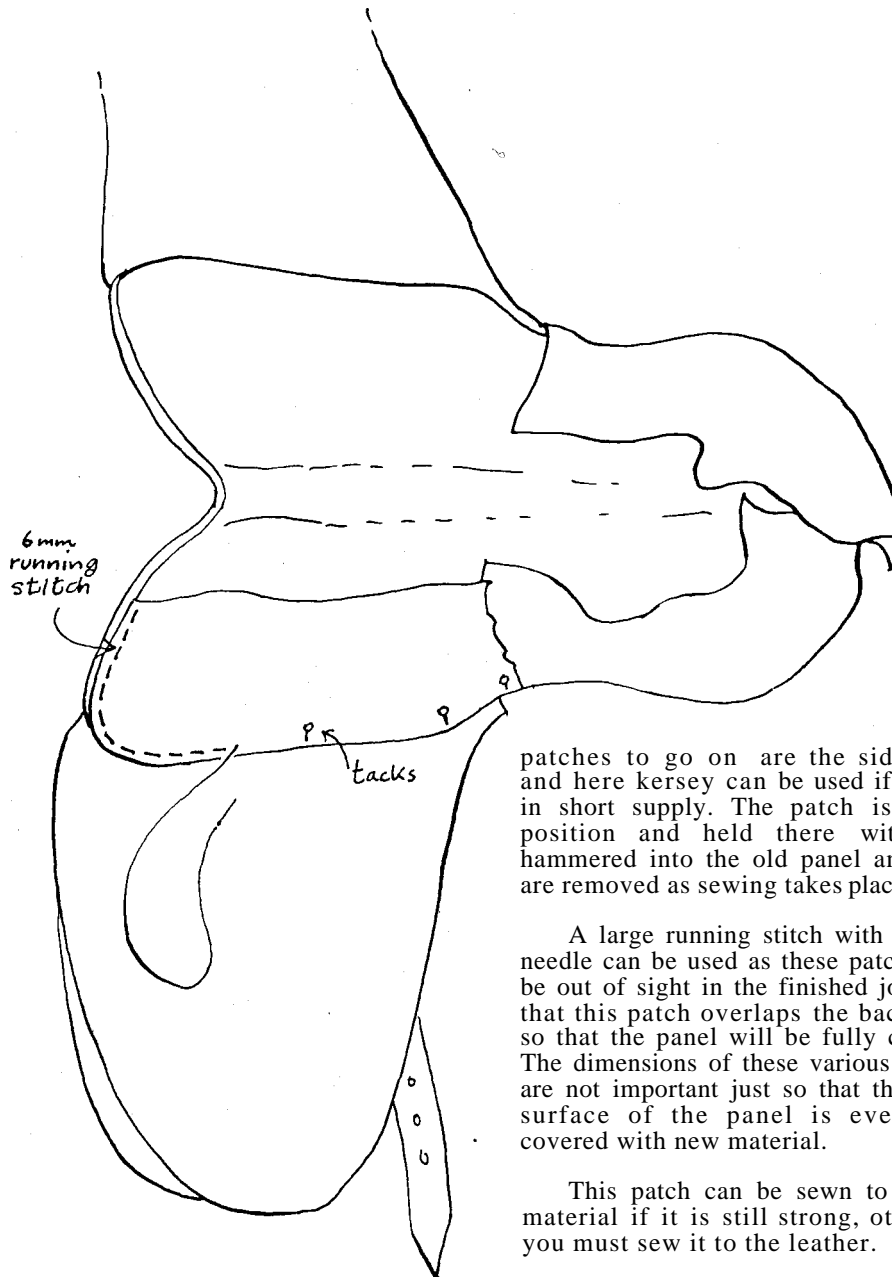

patches to go on are the side ones, and here kersey can be used if serge is in short supply. The patch is put in position and held there with tacks hammered into the old panel and these are removed as sewing takes place.

A large running stitch with a single needle can be used as these patches will be out of sight in the finished job. Note that this patch overlaps the back patch so that the panel will be fully covered. The dimensions of these various patches are not important just so that the whole surface of the panel is eventually covered with new material.

This patch can be sewn to the old material if it is still strong, otherwise you must sew it to the leather.

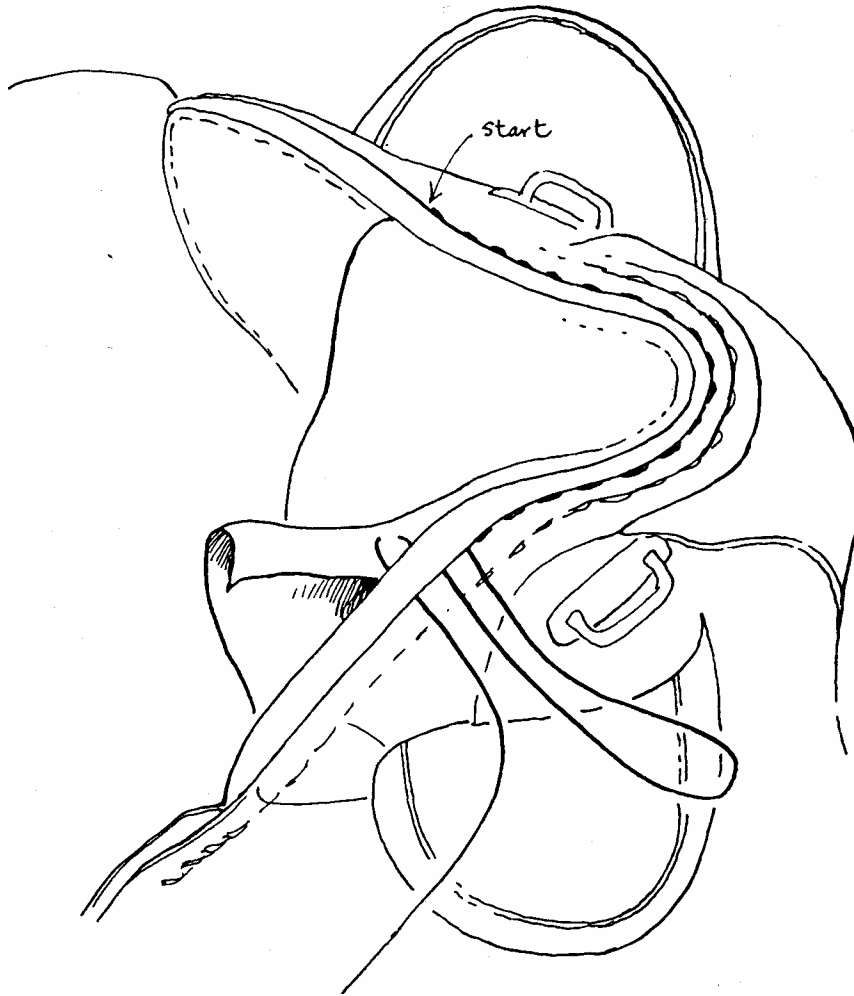

#### SEWING IN CHANNEL MATERIAL

Fig 4. Now is the time to sew in the new material for the channel. Notice in the sketch that the stitching takes place just a little way from the row of large stitches that can already be seen around the fore-part.

Not only does this make for easier sewing but it also avoids the chance of the sharp edge of the awl cutting through the stitching that is already in place.

This sewing starts and ends with a knot on the material side.

Note that the stitches only go through the turned over part of the material so that they are hidden from view.

Either Kersey or Serge can be used for this job.

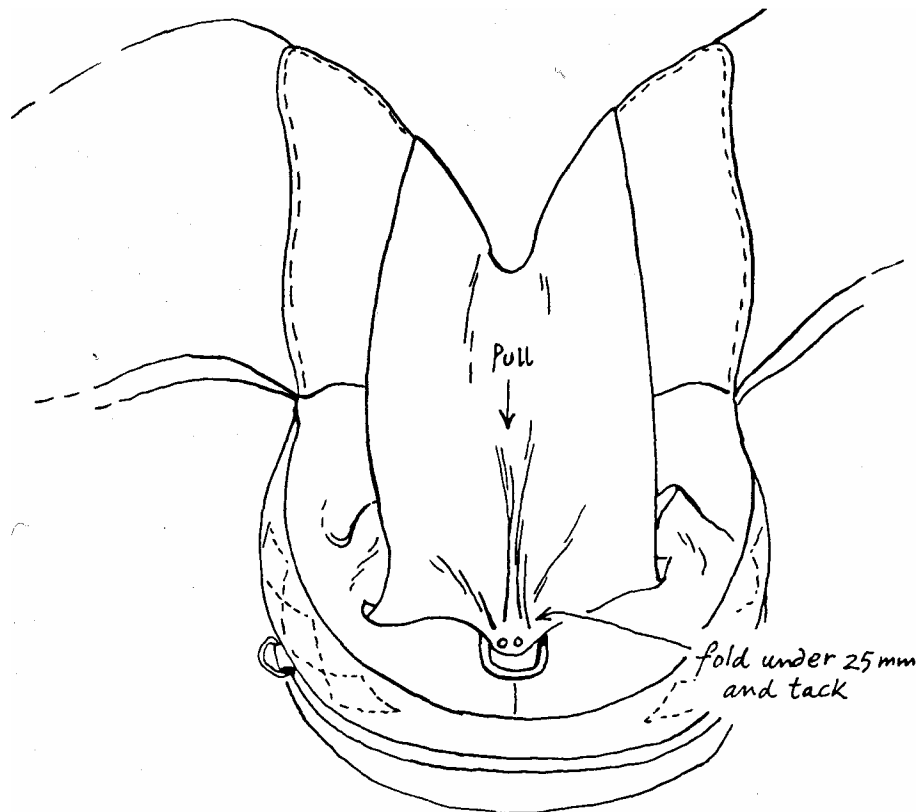
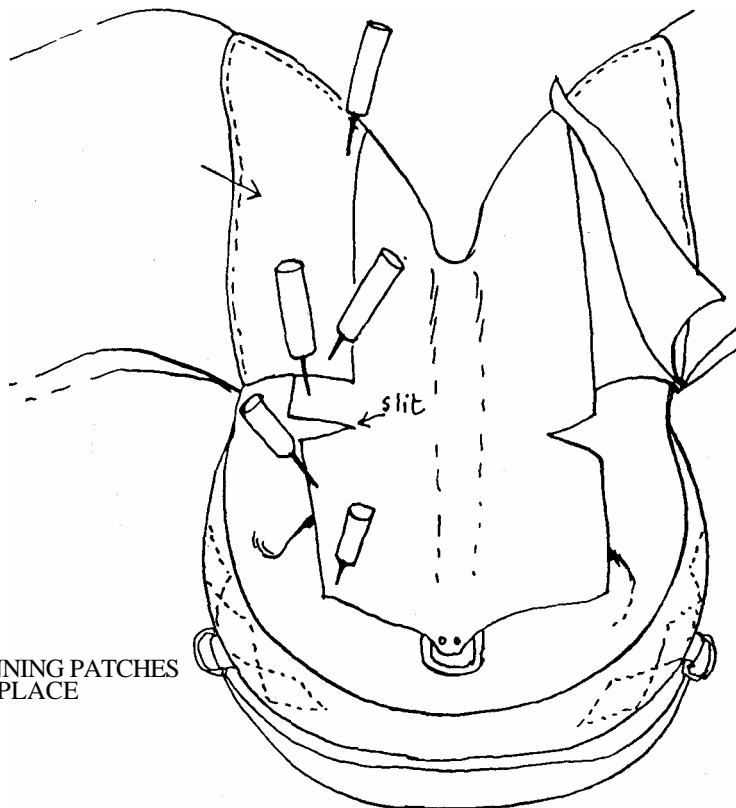

Fig 5. Now the material is pulled tight down the channel, folded over and tacked in place at the crupper bar.

If you are using patterned Kersey for the job make sure that the lines run straight down the middle as it looks bad if they head off at an angle.



6. PINNING PATCHES IN PLACE

Fig 6. A number of round awls will help during this next step, or long tacks can be used. Saddlers keep a number of round awls on hand for this sort of work, but the person who is only doing up his own saddle will not find it worthwhile to provide himself with these tools. Short lengths of fencing wire



sharpened at one end make a good substitute.

Do not use sharp edged sewing awls.

I made up a set in a short time by hammering 50 mm nails into scraps of dowel and sharpening the ends.

The awls are used to lever the material tight and keep it in position until it is sewn. One side is worked over at a time. The back patch will have to have one or two tucks taken in it to make it lay flat. Some time should be taken moving the awls around until the patches are all smooth and tight.

Notice that the channel material has also had a cut made on each side to help make it lay flat. This may have to be done in order to get the channel free of wrinkles.

The patches are laid out in the order shown. The back patch is covered by the channel patch, and this in turn is covered by the patch on the flap.

The reason for this is that the new stuffing will be pushed in from the top and by laying out the patches in this order the stuffing tool will not get snagged by jabbing into the edge of one of the patches.

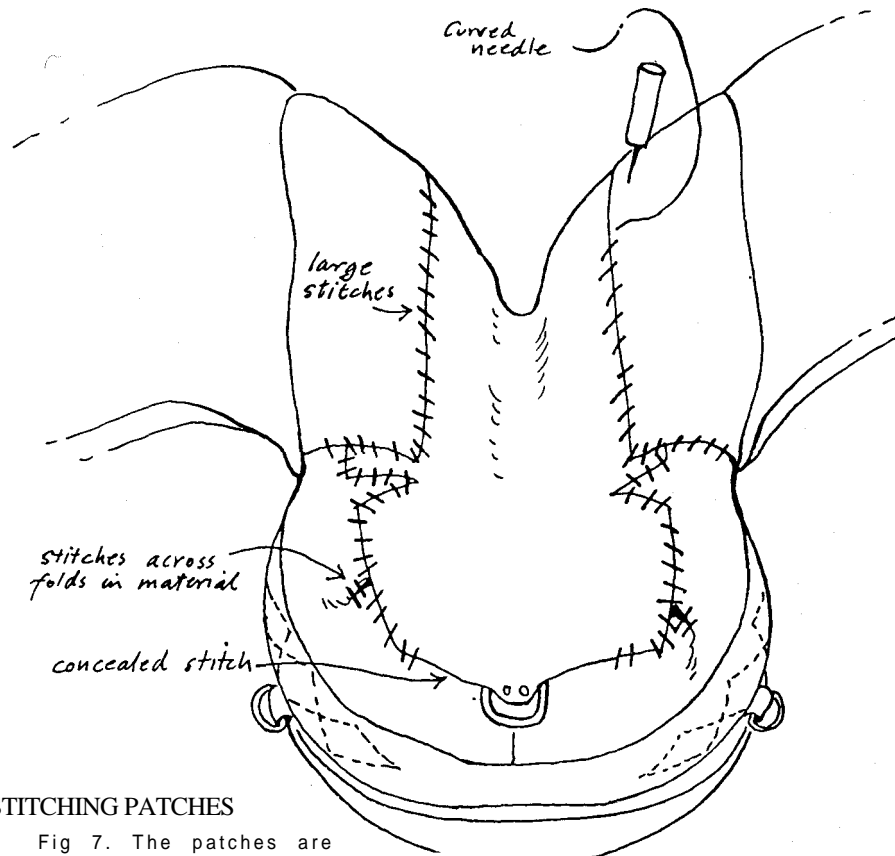

### STITCHING PATCHES

Fig 7. The patches are sewn down using a curved needle and good large stitches. Neatness is not necessary as the patches will soon be out of sight, but the stitching should be strong.

A few stitches also go across the folds in the material to keep them flat as shown.

Where the patch that covers the

channel comes near the crupper bar the concealed stitch should be used (this is shown in the section on counter-lining). The reason for this is that the material will be visible here in the finished job. About 40 mm on each side should be sewn with the concealed stitch.

Now the patching is complete and the actual counter-lining can begin.

## MATERIALS FOR COUNTER-LINING.

During manufacture the saddle is generally stuffed first with cattle hair which has been scraped from hides and is known by the romantic name of doehair. Doubtless in years gone by saddles were lined with the hair from does, but that time has long since passed.

Flock is sometimes used to fill saddles but many saddlers do not favour it as it has a tendency to move around in the panel and make it pancake out of shape. Never the less some expensive saddles are lined with flock so there is obviously room for argument. Wool has also been used.

Various synthetic forms of rubber have also been used, and though these save the manufacturing saddler money they have not yet been proved to be better than the traditional materials.

Synthetic rubber pieces are often used for counter-lining, but there is a general feeling amongst stockmen that they cause the horse's back to sweat too much under the saddle. To try and avoid this some saddlers place a layer of hair between the rubber and the material lining the saddle where it comes in contact with the horse.

These new materials can create unexpected problems. We recently had a saddle in our saddlery for repair and on examination found that the synthetic rubber had flattened and turned into a hard brittle plastic as hard as a bone knife handle.

So despite the prevailing belief that what is new must be the best, the fact remains that curled hair gives the best results for counter-lining.

This curled hair is often referred to as horshair, and probably for the same reason that the term doehair is used, because at one time horse hair was used for the job. The hair used today is actually from cows' tails.

It is often sold in the form of a sort of rope, and must first be teased out before it can be used. This is a time consuming job and it is better to buy it already teased. We buy teased hair from Stephans in Brisbane.

The general rule is that doehair is used by the saddle maker for the first stuffing of the panel and curled hair is used for the counter-lining. There are also saddles that are lined with a special type of heavy felt but we are not discussing those here.

It may be asked why doehair is used for the original stuffing but not for the second. The fact is that it could be, but the problem would then arise that it would also pack down into another hard layer as does the original panel. The curled hair retains its spring for a lot longer.

The idea is that the original layer of doehair will pack down and shape itself to the horse, and the curled hair of the counter-lining will provide a cushioning effect by retaining some spring.

Fig 1. To begin counter-lining two pieces of serge are taken. large enough to cover the existing



### TO BEGIN COUNTER-LINING

panel with around 50 mm overhang at each end and around the edges, and a 25 mm turn under down the channel as shown.

The first step is to get the material in the right position down the channel.

**IF THE SADDLE IS NEW.** Follow the large stitches that run down either side of the channel.

**IF THE SADDLE IS OLD.** It will probably be counterlined, so remove the old counter-lining and sew the serge down.

Using the old line of stitching holes as a guide. However it is important not to sew exactly to the old line of stitches as the material is always a little weaker at this point.

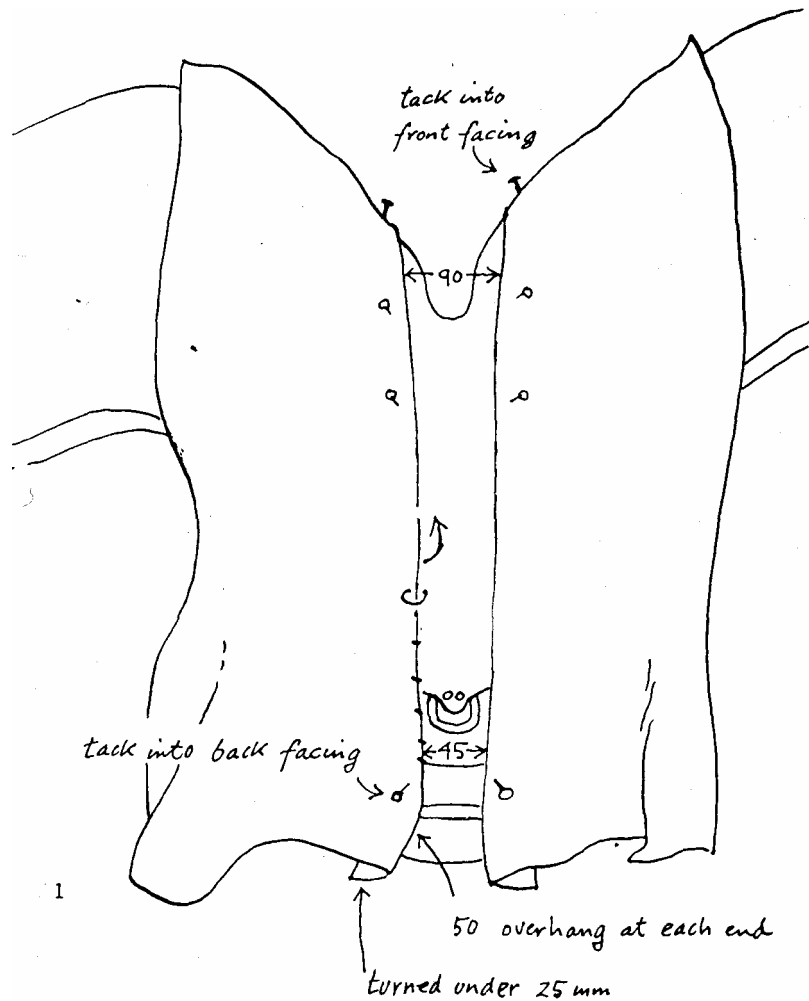

IF YOU HAVE JUST PATCHED THE PANEL. It is best to take a note of the width of the channel before sewing on the new patches, but if you have not done this then use the measurements in the drawing. These measurements are only a rough guide, on a narrow saddle the channel will be more than 90 mm at the front.

A study of a new saddle will show that the line of machine stitching flares out just at the front of the channel, but if measured straight across at about 50 mm in it will be seen to be around 90 mm wide and tapers towards the back until the two pieces are only 45 mm apart.

When counter-lining it is common

practise to keep the two seams in a straight line, but some saddlers give the line a slight curve.

Long tacks are used to position the serge before sewing. First the serge is tacked to the front facing then pulled down and tacked to the back facing. Then the seams are adjusted to the desired lines along the channel. Once they are in place they are held in position with more tacks, usually just pushed in with the thumb.

A single strong thread and a curved needle is used to sew down the material along the channel. Large stitches, up to 15 mm apart, can be used for this job.

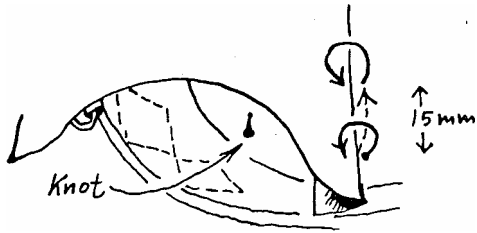

Fig.2. This shows the stitch used and how the job is begun. A knot is put in the end of the thread and this is positioned in the panel where it will be out of sight in the finished job.

To finish the stitching the needle is passed through the front facing, then back again and a knot tied. In all cases of finishing off threads common sense is

used rather than any hard and fast rules. The idea of going through the front facing and back again is simply to make the ending of the row more secure.

Once the serge has been sewn down along the channel we come to a part of the job where a certain amount of skill is needed. If the serge was to be sewn down all around just as it stands now there would be no room for the filling. If on the other hand the serge was marked and cut a little larger all the way round there would then be room for the filling, but it would be the wrong shape.

So the aim is to cut out the serge so that the filling will be in the required places. A look at a saddle will show that the filling is thickest at the back, and also at the front, and there is less of it in the centre.

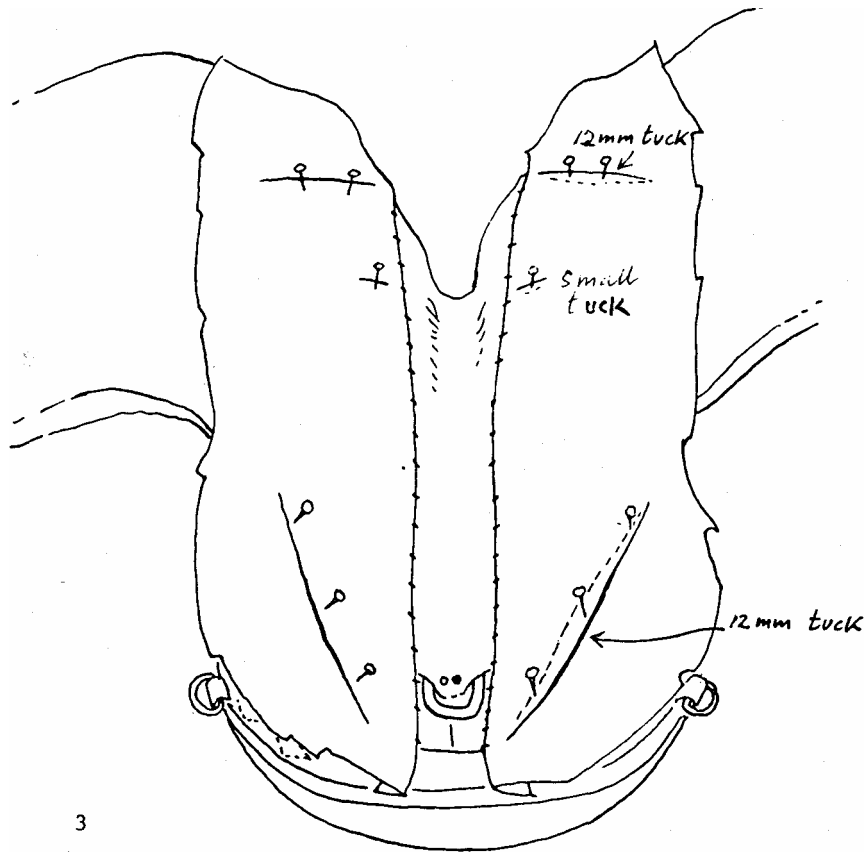

3

Fig.3. To allow for this the serge now has a tuck taken in it at the front and the back, and a tiny tuck just down from the front. The two main tucks are around 12 mm at their deepest, and a few tacks sometimes are used to hold them in place while the rest of the stitching continues.

The reason that this part of the job calls for some skill is that it is impossible to give accurate dimensions for the length and depth of these tucks as each saddle is slightly different from the next in both length and width.

The saddler who is continually doing counter-lining will tell at a glance the amount of tuck needed, but the person

who is doing his first saddle really cannot tell whether a 12 mm tuck will give his particular saddle the fullness of panel that he desires.

For instance if the filling in the original panel has settled down to only a thin layer then much more filling will be needed than for the saddle that has only compressed a little. So a larger tuck will be needed for a saddle that is very worn to allow for more filling, and a smaller tuck will do for a relatively good saddle because less new filling will be needed.

The saddle that I used for the sketches was about average, that is to say it had been left too long before being brought in for counter-lining.

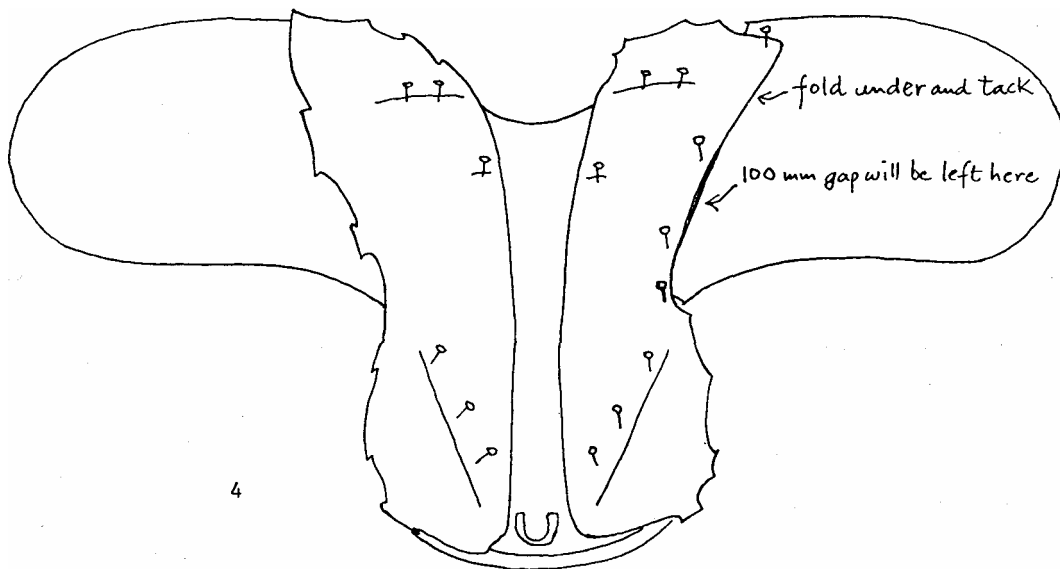

Fig.4. Fold the serge under to make a neat edge across the sweat flap and hold it in place with a few tacks. The serge can exactly follow the line of the panel underneath or it can be a little larger if so desired.

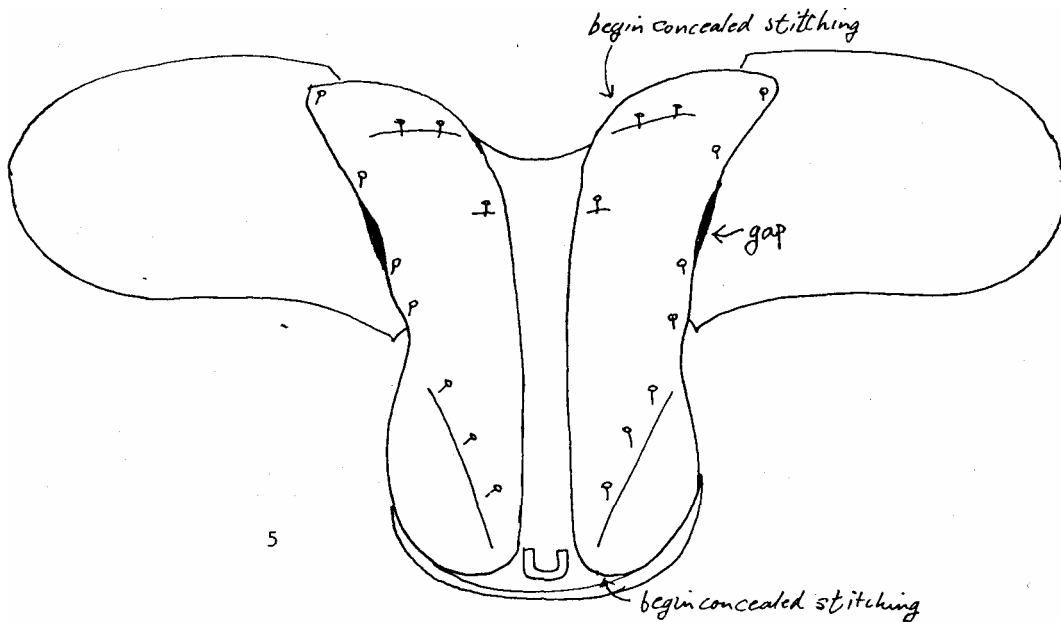

Fig.5. Using the concealed stitch shown in figs 6 and 7 sew the new serge to the old serge. Place the stitches as close to the leather of the back facing as possible so that only a tiny strip of the old serge will show. Remember that the stitching goes through the serge underneath, not through the leather.

This is why the old serge must be in good order. If it is at all rotten then a patch must be put over it as described earlier.

Stitching begins at the back of the panel next to the channel. Because of the shape of the saddle the new serge will pucker a bit around the back. Organize your stitching so that you take up a little of the pucker at each stitch, in this way all the pucker will have gone by the time you reach the sweat flap.

Stitching then begins at the front, again next to the channel, and continues until the other side of the gap is reached. As before puckering takes place at the beginning.

This puckering is needed in order to make the new serge fit onto the old serge without folds and creases.

If you are following the line of the old serge when sewing the new serge across the sweat flap then the concealed stitch can be used, but do not forget to leave a gap as shown.

If you are placing the new serge in a different position on the sweat flap then it will have to be sewn down through the flap using ordinary stitches.

There is no real need to use the concealed stitch when going across the sweat flap area. The final job will look just as neat with a row of well placed in and out stitches going through the sweat flap. Do what you find easiest as long as the serge is firmly sewn down.

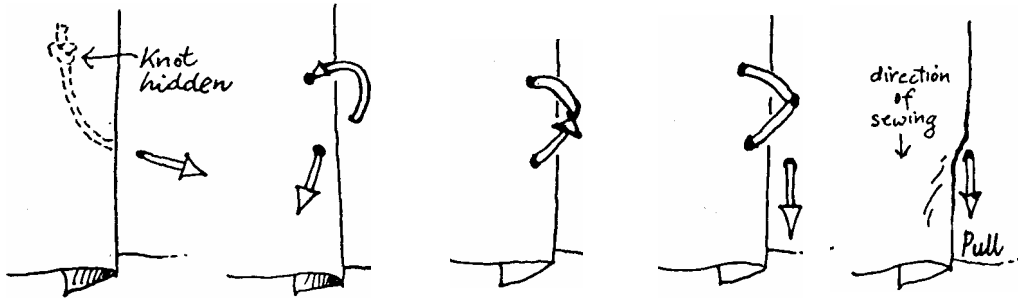

CONCEALED STITCH

Fig.6. There is a special concealed stitch used in counter-lining, and though it- may take a few minutes to understand it is simple to do once the idea has been grasped. A single thread is used and a curved needle known as a counter-lining needle. This needle has a diamond

cross-section at the working end just like a sewing awl, and can be between 50 and 70 mm long. Stitching begins by putting a knot in the end of the thread and passing the needle through a part of the old panel underneath where the knot will be hidden from sight.

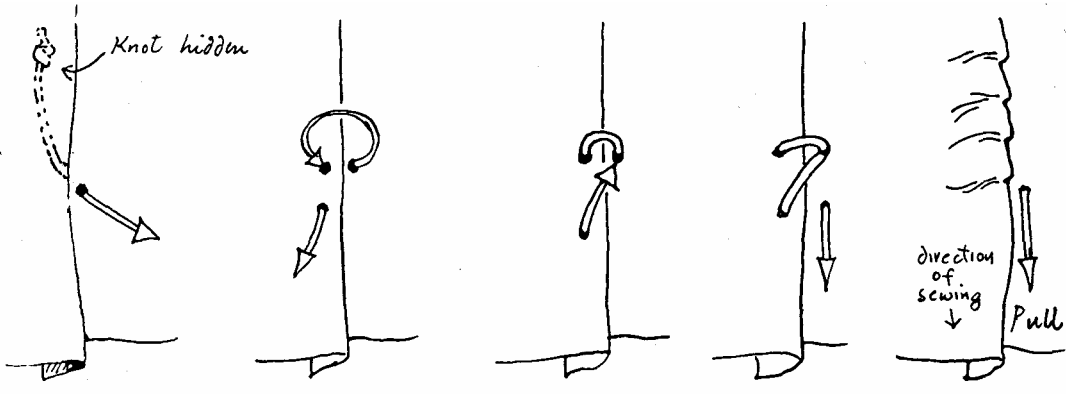

7 CONCEALED STITCH (for puckering panel)

THE CONCEALED STITCH USED FOR PUCKERING THE PANEL

Fig.7. The concealed stitch can be formed in two ways. By doing it one way the top layer of material is puckered up, and in the other way it will remain flat. The puckered stitch is used at both the back and the front of the saddle, and this gradually changes to the unpuckered one as the row of stitching approaches the middle. I should not really say 'row of stitching' as the stitching will be invisible if done properly.

In both series of sketches the stitching is proceeding downwards. Both types of stitching will be seen to be following the same pattern, the only

difference is the way that the holes are lined up.

If the saddle has not been counterlined for a long time then the counter-lining will need to be thick because the old lining will have been ridden flat. This means that large tucks will need to be taken in the serge, as illustrated on page 250.

When you come to sew on the new serge it will be found that the material will not lay flat unless it is puckered. This must be done around both the back and front of the panel.

Less puckering is needed on a panel that has not been ridden flat. You can judge by eye how much puckering is needed in each case and adjust your stitching accordingly.

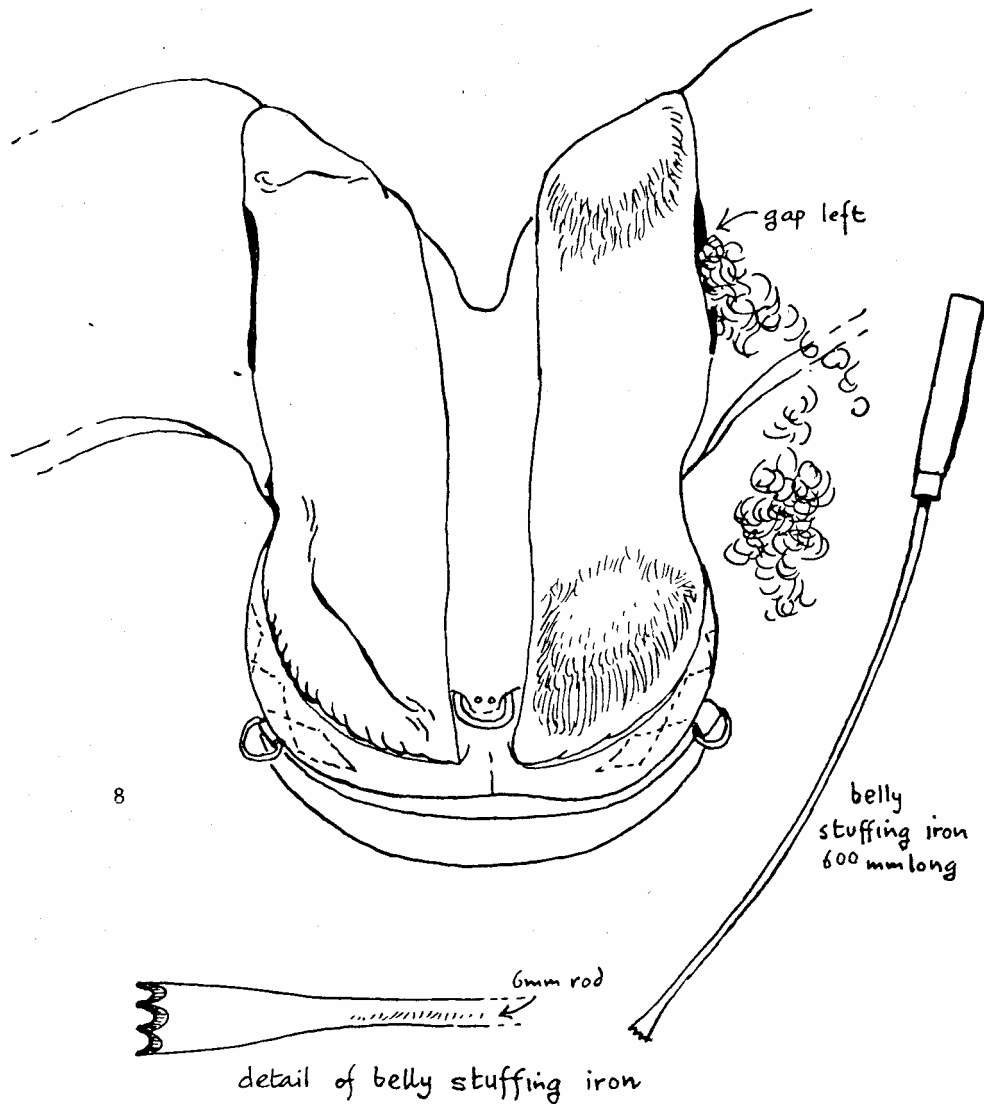

#### SERGE SEWN AND FILLING BEGUN

Fig 8. Once the stitching is completed the tacks are removed from the tucks and the filling can begin. If the curled hair has been bought in the form of a rope it will need to be teased out first, taking care to remove any burrs or knots.

To get the hair packed down to the far end of the panel a special tool is needed called a belly stuffing iron. These are hardly worth purchasing as they can be made so easily. A piece of 6 mm or thereabouts steel rod is used with an overall length of 600 mm. I put

a wooden handle on mine, but even this is not necessary.

The end of the rod is hammered flat and a number of grooves filed into it so that a row of teeth are formed after the style of the detail in the sketch. These small teeth aid in pushing the hair down inside the panel.

Care must be taken to ensure that these teeth are not sharp as one sharp edge is enough to tear through the serge and ruin the whole job. It is a good idea to jab the tool into the ground repeatedly to take off any burrs or sharp edges.



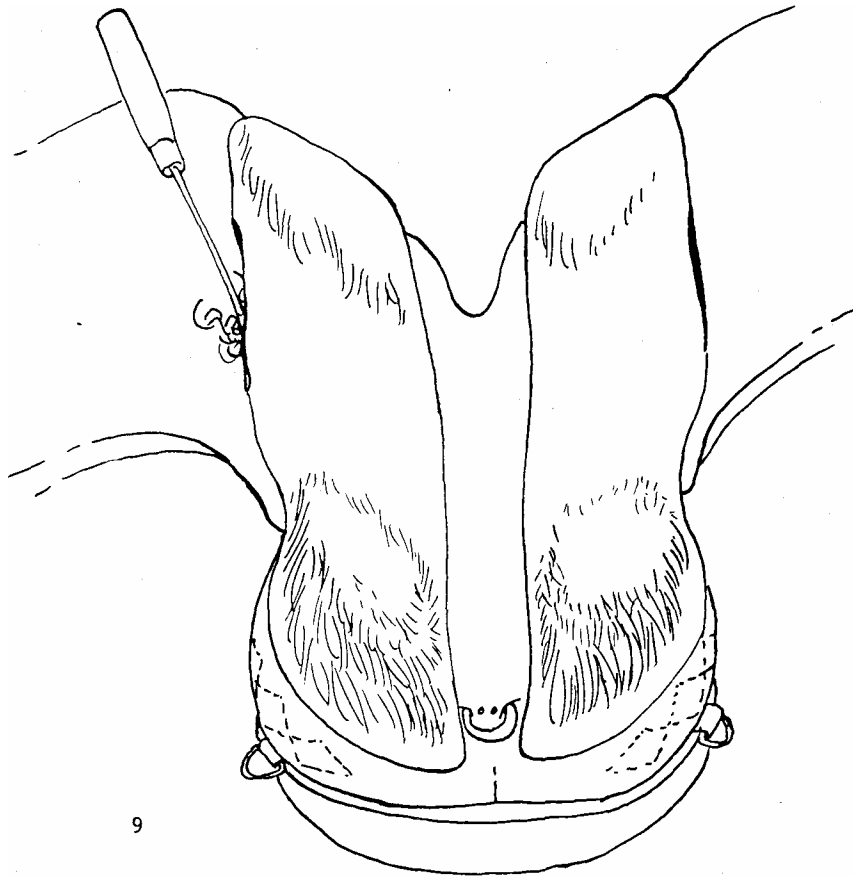

### FILLING TOP AND BOTTOM

Fig.9. Both the top and bottom of the saddle are filled at first using the belly stuffing iron to get the panels to the right shape at either end. Hammering with the fist will also help shape the panels.

It is best to try and get the curled hair as firmly pushed in as possible and get the panel to the correct shape at this stage. Put in a handful of hair at a time and use the end of the tool to compress it.

10

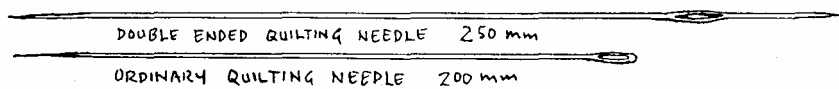
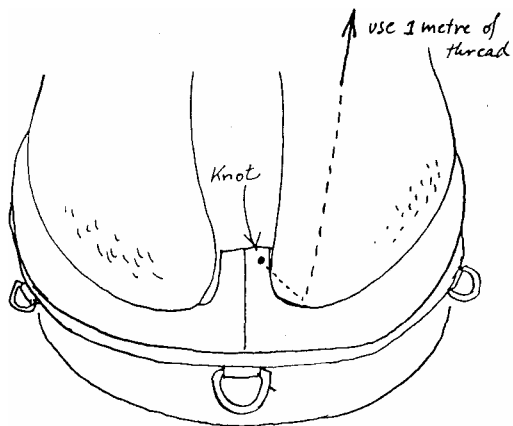
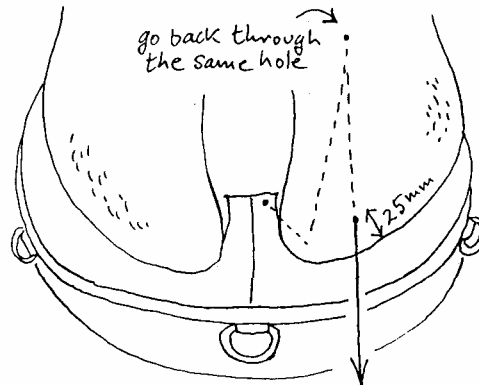

Fig.10. When the ends have been filled and shaped as much as possible the quilting can take place. Very long needles are needed for this job. They are known as quilting or mattress needles and are obtained through people who deal in canvas if they cannot be bought from a saddler. There are two

types, one shaped like an extra long ordinary needle and the other sharpened at both ends. They come in various lengths from 200 to 250 mm. The double ended needle is the best to use if it is available *as* the needle does not have to be reversed at the end of each stroke.



11



12

START OF QUILTING.

Fig. 11. To begin, the end of the thread is knotted and put through the panel at a place where it will not pull through. With this in mind it will help if it goes through some of the old doehair.

Fig. 16. If an ordinary type of needle is used then it must be pulled right through and great care taken to see that it goes back into the same hole that it came through.

The end of the needle comes out through the serge as shown. If a double ended needle is being used the whole needle need not come through the serge, once the eye of the needle is seen it can be pushed back again as explained in

Fig. 12. The idea is that the stitches do not have any connection with the top layer of serge. What they actually do is go in and out of the panel and as they do so they get wrapped around a big lump of curled hair inside. As they are pulled tight so the curled hair is pulled tight against the back of the panel.

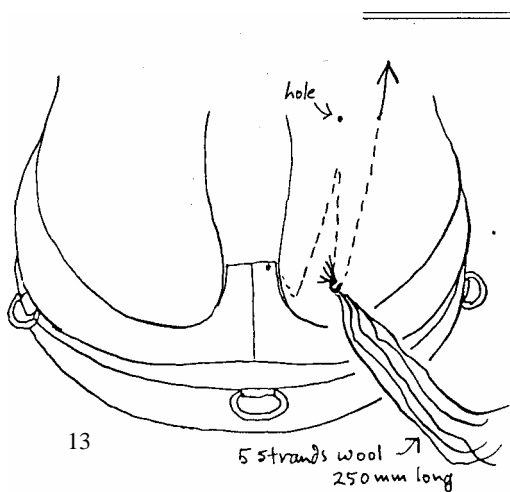

13

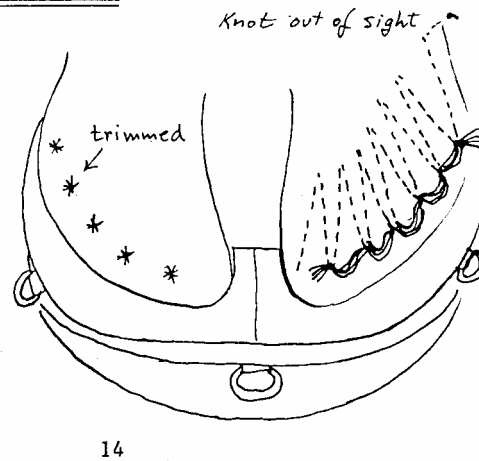

14

Fig. 13. When the needle comes through as shown in Fig. 12. 4 or 5 strands of wool are taken and placed against the thread. The needle is then pushed back into the panel 3 mm from where it came out wrapping around the

wool as it does so.

The same sort of stitching continues, and each time it comes out at the back of the panel a stitch goes around the strands of wool. The stitches have to be pulled in quite tight as the work

progresses otherwise the wool will fall out later.

This wool is not just for ornament, its job is to prevent the stitch pulling through the serge as it is tightened up.

Fig. 14. When the stitching is finished a knot is tied in the thread somewhere up under the flap where it will be out of

sight, and the strands of wool are all firmly in place as shown in the right hand side of the sketch.

Now the wool is trimmed with a pair of scissors and forms a decorative row as shown in the left of the same sketch.

The front of the saddle is quilted in the same way.

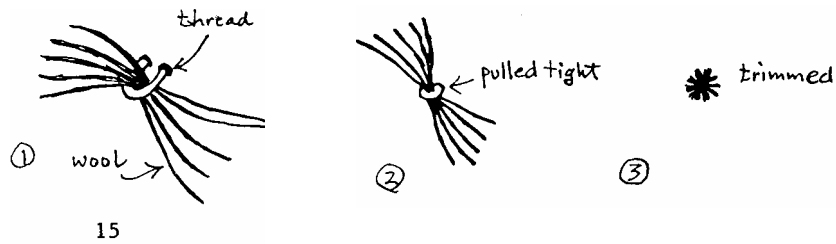
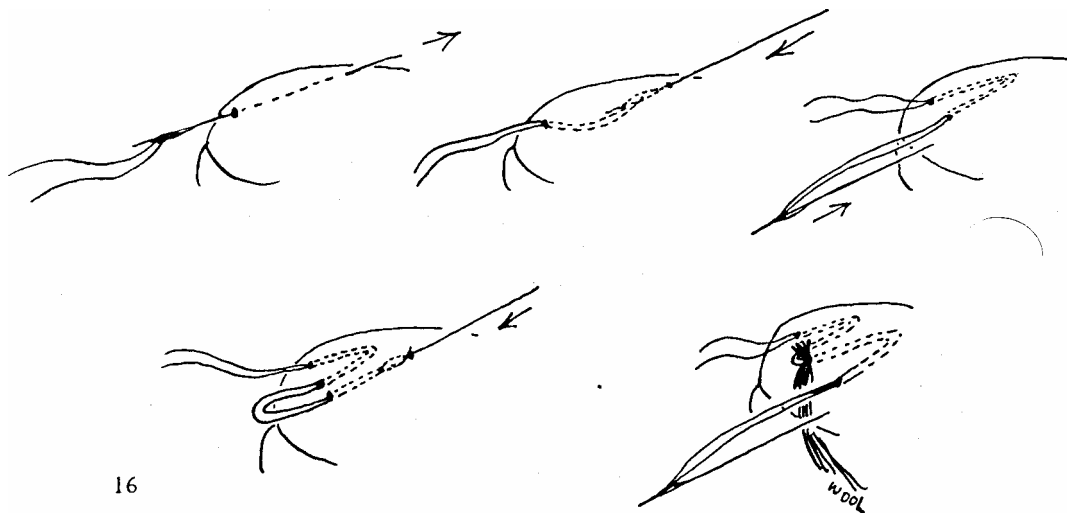

Fig. 15. This is a closeup to show how the wool is caught up by the thread.



#### USING THE DOUBLE ENDED NEEDLE

Fig. 16. This is how to use the type of needle that has a point at each end. It is quicker to use this for the job than the ordinary type of long needle.

Notice that the direction of the needle is reversed just before the eye of the needle comes to the top surface.

When the needle is pulled back as in the third sketch it is completely removed from the serge and makes a new hole when it goes in again, about 3 mm from the previous one. The wool is caught up in the loop that is thus formed.

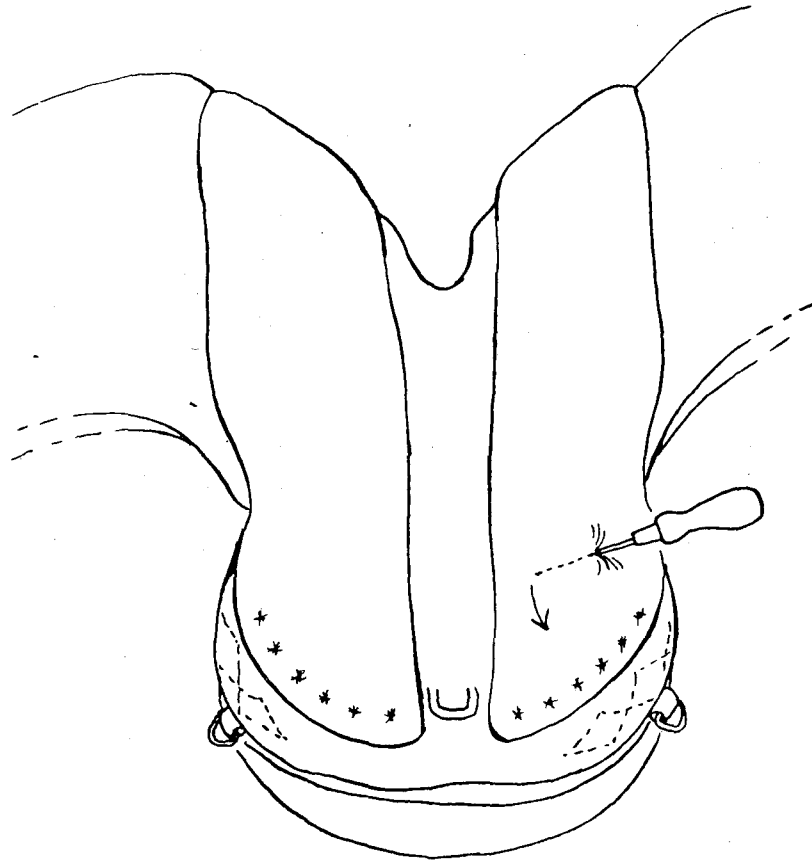

#### USING THE SEAT AWL

Fig. 17. When the quilting has been completed it will have pulled a quantity of the curled hair into a "wall" at the back and front of the panel. Now the rest of the panel is filled with hair, trying to get it correctly into place with the stuffing iron.

Inevitably there will be a few lumps, in the panels and these must be removed. A certain amount can be removed by thumping with the fist. Saddlers sometimes used a domed piece of wood to help with this job, called a leather smasher, but they do not seem to be available any more. Luckily you can get along without it.

To get the final smooth surface the panel is gone over with a tool known as a Seat awl. This has a smooth round shaft which can be pushed into the serge without damaging it in any way. It must not be confused with a sewing awl. The sewing awl has sharp edges, and if one was used for this job it would cut

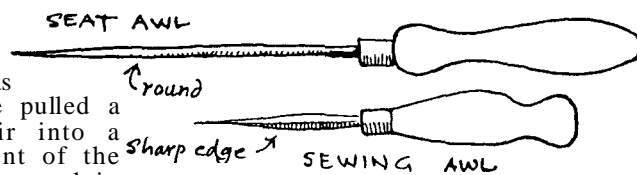

threads of the serge as it was pushed in and out.

The seat awl is used to push the curled hair wherever it is needed and so pack it firmly and remove all the lumps. The awl is simply pushed through the serge and the point moved around. It is surprising how the hair can be moved around in this manner.

The panel is carefully awled smooth, working from each end towards the gap. When all the filling is in place the gap is then sewn up.

If the gap has been a large one it is sometimes desirable to pause just before the gap is completely closed up and put in the very last bit of hair along this area.

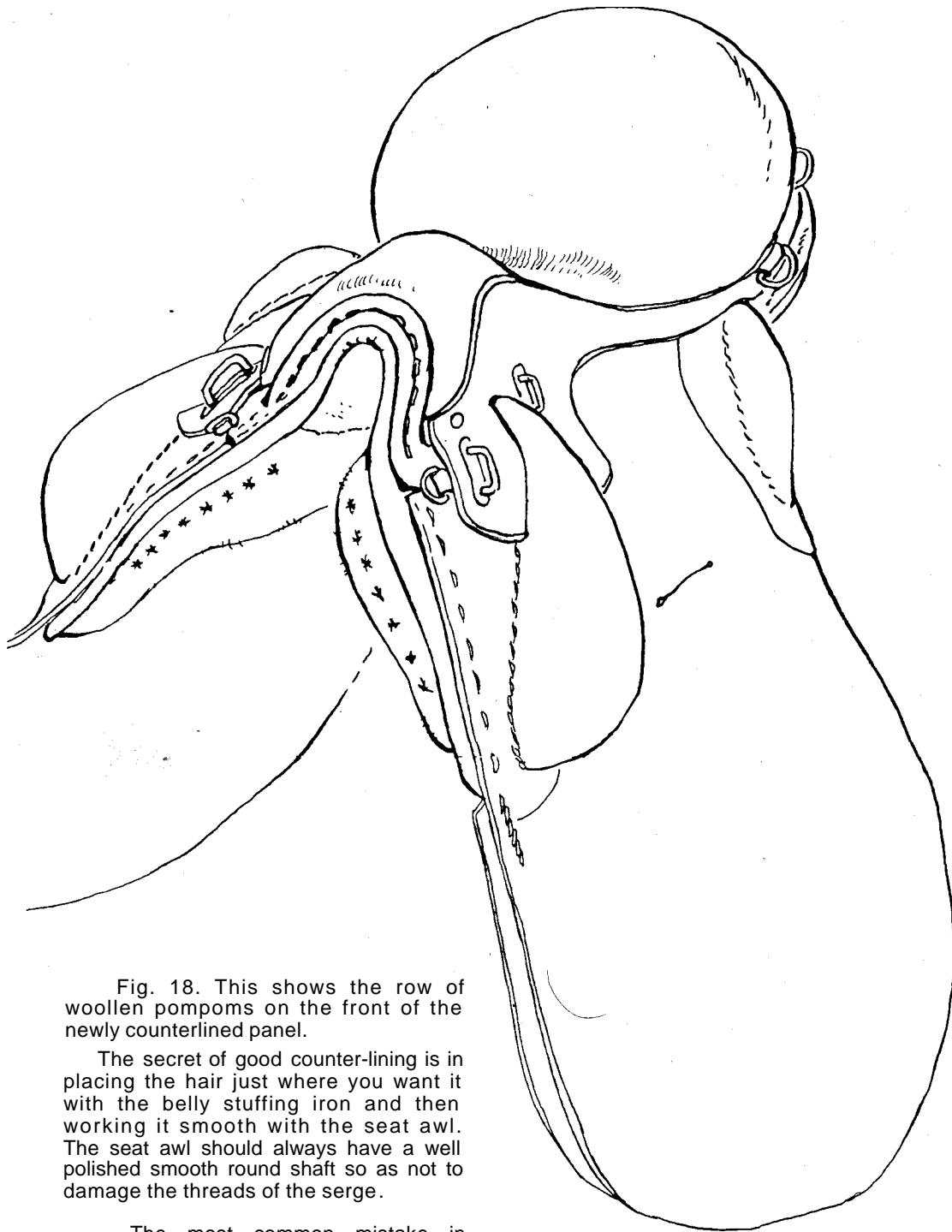

Fig. 18. This shows the row of woollen pompoms on the front of the newly counterlined panel.

The secret of good counter-lining is in placing the hair just where you want it with the belly stuffing iron and then working it smooth with the seat awl. The seat awl should always have a well polished smooth round shaft so as not to damage the threads of the serge.

The most common mistake in counter-lining is to not pack the hair in firmly enough. The finished job should be firm and springy, not soft.

## ABOUT THIS BOOK

This book deals with a wide variety of the traditional leather crafts that are still practised today in the Australian bush. It covers a wide field, from the kangaroo hide plaited belt and the pouches that are worn on it to stockwhips and saddle repairs.

All the common plaits, braids and lacing techniques are also described as well as instructions for making a wide variety of leather tools.

The book is well illustrated, with over 1200 drawings by the author.

## THE AUTHOR

Ron Edwards lives in Kuranda, far north Queensland. The Craft Shop Saddlery in Cairns is a family business, but he devotes most of his time to writing books on traditional bush crafts and folklore.

He began practising leatherwork in 1940 at the age of ten in a small country town ship near Geelong, Victoria, and still makes his own saddles.